

Top Freezer F Deep Door Use & Care G

TG18R3, TP19R3, TP22R3, TX1
TX21R, TX22R2, TX22R3, TX2
TXI22R3, TXI22R, TXI25R4
TZ19R, TZ22R2, TZ22R3, TZ
TZ22R3, TZI22R

CONSUMER INFORMATION LINE



TOLL FREE

1-800-843-0304

Contents

Installation		Other Features	
Electrical Requirements	2	Decorator Doors	10
Model Identification	3	Normal Operating Sounds	11
Setting Controls	4	Care and Cleaning	
Refrigerator Features	5	Exterior	12
Installing and Using Specific Features	6	Adhesives	12
Adjustable Cantilever Shelves	6	Interior	12
Deli Fresh Chiller	6	Adhesives	12
Utility Rack	6	Dairy Storage Door	12
Crispers	6	Second Serving Containers	12
Egg Storage	7	Deep Door Shelves	12
Adjustable Dairy and Second Serving Shelf		Crisper Drawers/Removal	12
System	7	Odor Removal	14
Butter Dish	8	Door Gaskets	14
Snack Compartment	8	Mechanical	14
Buckets	8	Condenser Coil	14
Shelves	8	Light Bulbs	14
Tall Package Retainer	9	Energy Tips	15
Hugger	9	Vacation Tips	15
Freezer Features		Before Calling For Service	16
Free-O'-Frost™	9	Warranty	18
Ice Cube Trays	9	Warranty Exclusions	
Ice Service Rack	9	Temperatures	18
Automatic Icemaker	9	Removing/Reversing Doors	18
Adjustable Freezer Shelf	10	Asure™ Extended Service Plan	19
Adjustable Freezer Door Buckets and Shelves	10	Consumer Information Line	19
Reversible Freezer Storage Rack	10		

Electrical Requirements

RECOGNIZE THIS SYMBOL AS A SAFETY PRECAUTION

WARNING

Electrical Grounding Instructions—This appliance is equipped with a three-prong (grounding) plug for your protection against possible shock hazards. Where a two-prong wall receptacle is encountered, it is the personal responsibility and obligation of the customer to contact a qualified electrician and have it replaced with a properly grounded three-prong wall receptacle in accordance with the National Electrical Code.

Unit is designed to operate on a separate 103 to 126 volt, 15 amp., 60 cycle line.

DO NOT UNDER ANY CIRCUMSTANCES CUT OR REMOVE THE ROUND GROUNDING PRONG FROM THE PLUG. THE UNIT MUST BE GROUNDED AT ALL TIMES. DO NOT REMOVE WARNING TAG FROM THE SERVICE CORD.

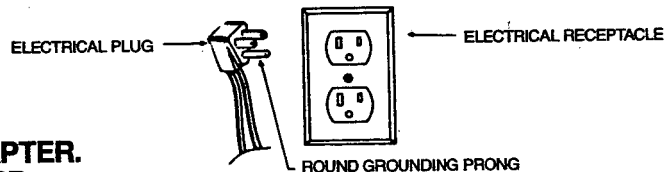

WARNING

DO NOT USE A TWO-PRONG ADAPTER. DO NOT USE AN EXTENSION CORD.

Setting The Controls

Temp-Assure™ thermostatic control

This control, located on center divider between freezer and refrigerator sections, operates independently of freezer control. A hidden thermostatic sensor measures refrigerator air temperature constantly, and automatically lets in more cold air if temperature rises as little as $1\frac{1}{2}^{\circ}\text{F}$ ($.8^{\circ}\text{C}$) from setting.

Refrigerator and freezer controls

- Locate refrigerator and freezer controls at inside center divider between freezer and refrigerator sections. See Figure 1.



Figure 1

- When freezer control is set to "OFF", neither refrigerator or freezer sections will cool.
- Start by setting both controls to "4". After 24 hours, adjust as desired. "1" is warmest setting. "7" is coldest.
- If you want to set temperatures more precisely, use a household thermometer that includes temperatures between -5° to $+50^{\circ}\text{F}$ (-20.5° to $+10^{\circ}\text{C}$). These can normally be purchased at a hardware store.
- In freezer section, put thermometer snugly between frozen food packages. See Figure 2.

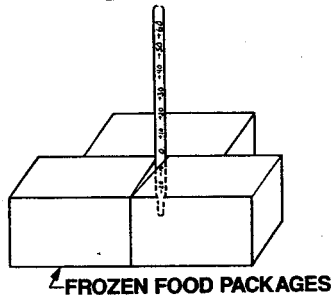

Figure 2

- Wait 5-8 hours. If temperature is not 0° to 2°F . (-18° to -17°C), adjust control, one number at a time. Check again after 5-8 hours.
- In refrigerator section, place thermometer in a glass of water and place in middle of refrigerator. Wait 5-8 hours. If temperature is not 38° to 40°F ($+3^{\circ}$ to $+4^{\circ}\text{C}$), adjust the control, one number at a time. Check again after 5-8 hours. See Figure 3.

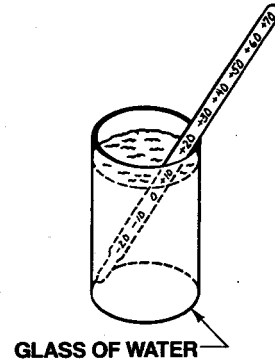

Figure 3

Exterior Cabinet Moisture Control

During hot, humid weather, any refrigerator will form moisture around doors, similar to condensation that forms on a glass of ice water. Special heaters in the refrigerator cabinet help minimize condensation.

- If refrigerator is in a warm, humid area, set control to "ON" position.
- If refrigerator is in a cooler, less humid area, set control to "OFF" position.
- As weather conditions change, this setting may need to be adjusted. At any time moisture forms on refrigerator cabinet, move control to the "ON" position. See Figure 4.



Figure 4

Installing and Using Specific Features

Refrigerator

Adjustable cantilever shelves

Shelves can be adjusted to best match size of items stored in refrigerator. These shelves are supported by metal tracks in back of the refrigerator.

- To remove "cantilever" shelves, tap upward at back of shelf, near the metal track. See Figure 6. This will loosen shelf hooks. Lift shelf and pull out.

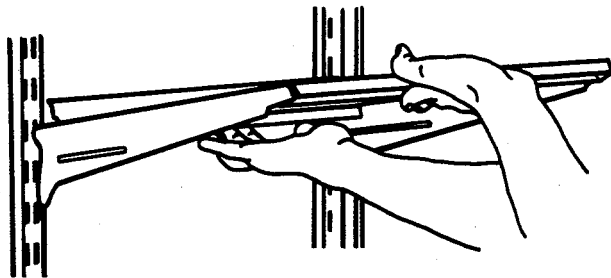
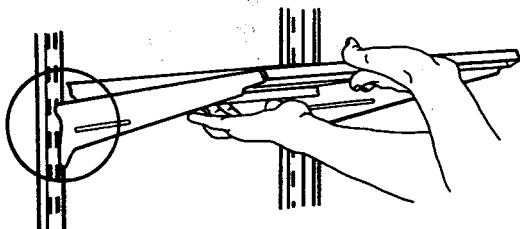

Figure 6

- To install, tilt shelf so that front is higher than back.
- Insert metal hooks at back of shelf into desired slot in metal track on back wall of refrigerator. See Figure 7.



CAUTION:
Apply pressure to front edge of shelf to insure proper installation.

Figure 7

Deli Fresh Chiller control

The Deli Fresh Chiller features a drawer inside an outer sleeve. A control, located on front trim, allows you to adjust amount of freezer air circulating between Deli Fresh Chiller and sleeve to keep meat, fish or poultry fresh without drying it out.

- Slide control to left for coldest temperatures (ice crystals may form) and to right for warmer temperatures. See Figure 8.



Figure 8

- Additional cold air can affect refrigerator compartment so Temp-Assure™ control may need to be adjusted once the Deli Fresh Chiller control is set. See page 4.

To move Deli Fresh Chiller

- Remove Deli Fresh Chiller drawer.
- Tap upward on back of shelf, near metal track. This will loosen shelf hooks.
- Lift shelf and Deli Fresh Chiller sleeve and pull out.
- To reinsert, lift the shelf and sleeve so front is higher than back.
- Insert metal hooks at back of shelf into desired slot in metal track on back wall of refrigerator. (Any of top three slots will work.)
- Gently lower shelf front. Tap downward near track until shelf hooks are securely seated and shelf is level.
- Reinsert Deli Fresh Chiller drawer.

If you choose to move Deli Fresh Chiller to opposite side of refrigerator, be sure to move reversible Deli Fresh Chiller control (located on center back wall of refrigerator section) to match the same side as you placed the Deli Fresh Chiller. See Figure 9.

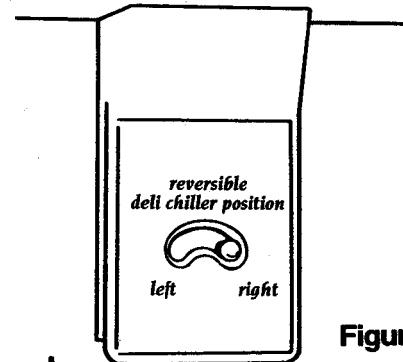

Figure 9

Utility rack

This rack can be hung from edge of any shelf, to hold a large bottle, eggs, cheese, etc., within easy reach.

- Locate utility rack shipped inside crisper drawer.
- Locate tabs on flat edge of utility rack. Hook these tabs over metal frame on side of any shelf. Shelf may need to be moved, depending on location.
- If bottle is used, be sure bottle cap is on tightly before placing bottle in rack. See Figure 5.

Crisper drawers

Crisper drawers are used to store fresh fruits and vegetables. It is normal for some moisture to accumulate inside drawers. Some models have humidity controls on one or both drawers.

- Slide control to high humidity setting for leafy vegetables such as lettuce, spinach or cabbage. See Figure 10.

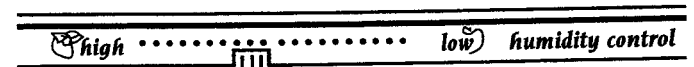

Figure 10

- Slide control to low humidity setting for produce with skins, such as apples, oranges or tomatoes. See Figure 10.

Installing and Using Specific Features (Cont.)

Butter dish

Allows you the convenience of tablespoon portions. See Figure 16.

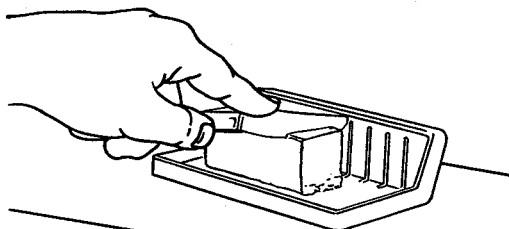

Figure 16

Snack compartment

Allows you to store small items and snacks at an easy, convenient location.

- To remove, open lid, place hand below center of upper shelf, lift straight up. See Figure 17.

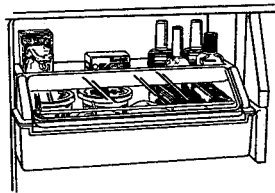

Figure 17

- Removing the upper portion of this compartment allows the flexibility of using the bottom portion as an additional door bucket.

Deep door buckets

- To remove door buckets, remove food from all buckets.
- Push lock tabs toward center with your thumbs and forefingers. See Figure 18.

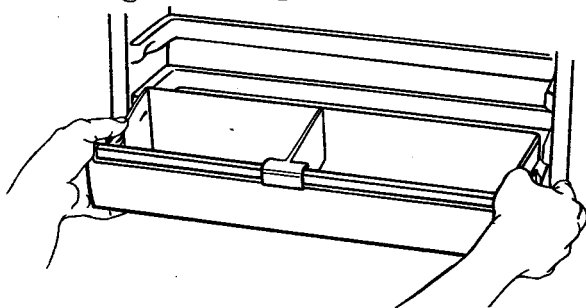

Figure 18

- Pull bucket straight out. See Figure 19.

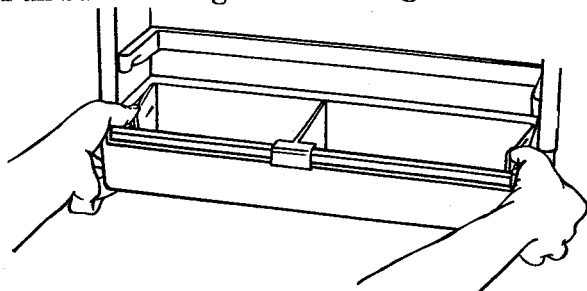

Figure 19

- To install, slide bucket into grooved area until tabs lock into place. See Figure 20.

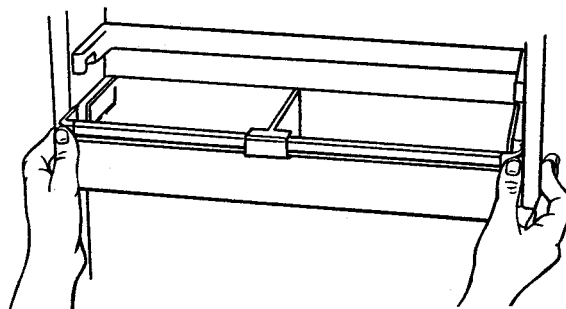

Figure 20

Deep door shelves

Adjustable deep door buckets on refrigerator door allow for easy storage of six-pack or gallon size items. See Figure 21.

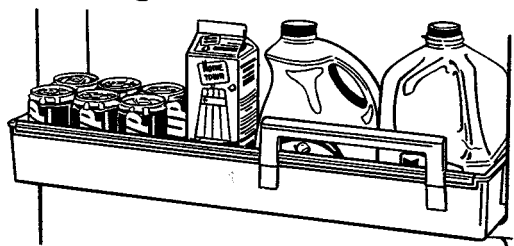

Figure 21

- To remove door shelves, remove food from all shelves.
- Grasp each side of retainer.
- Pull shelf straight up. See Figure 22.

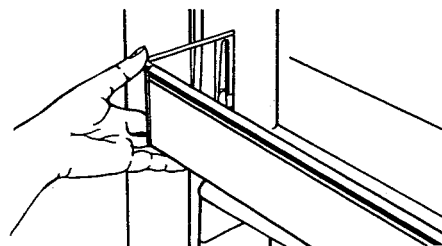

Figure 22

- Then pull out to remove. See Figure 23.

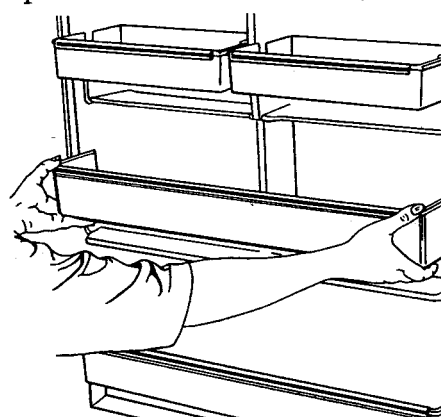

Figure 23

Installing and Using Specific Features (Cont.)

Adjustable freezer cantilever shelves (some models)

Shelves can be adjusted to best match size of items stored in freezer. These shelves are supported by metal tracks in back of the freezer.

- To remove "cantilever" shelves, tap upward at back of shelf, near the metal track. See Figure 27. This will loosen shelf hooks. Lift shelf and pull out.

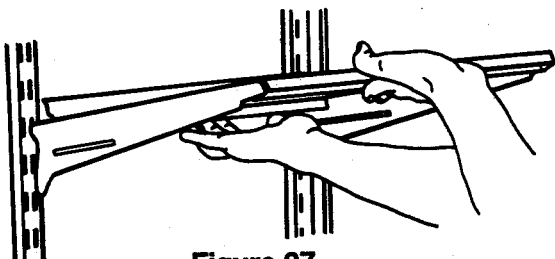

Figure 27

- To install, tilt shelf so that front is higher than back.
- Insert metal hooks at back of shelf into desired slot in metal track on back wall of freezer. See Figure 28.

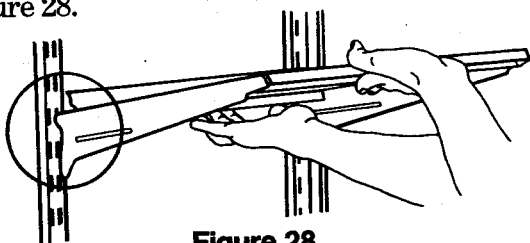

Figure 28

CAUTION:

Apply pressure to front edge of shelf to insure proper installation.

Freezer shelf divider (some models)

Some models have a freezer shelf divider to separate frozen food on top of shelf.

- To move divider to a different location, first press down on divider and slide forward about 1" to unhook middle wire.
- Move divider to new position, positioning ends of the divider base under freezer shelf wires.
- Press down on divider and slide backward, to hook middle wire and stabilize divider.

Adjustable freezer door buckets and shelves

There are two deep door buckets and one full-width door shelf located on freezer door for convenient storage.

- Buckets and shelves can be removed for easy cleaning. To remove, follow directions in steps a-c on page 8.

Reversible freezer storage rack (some models)

Reversible freezer storage rack may be placed on top of or underneath freezer shelf to be used to organize and separate frozen foods. See Figure 29.

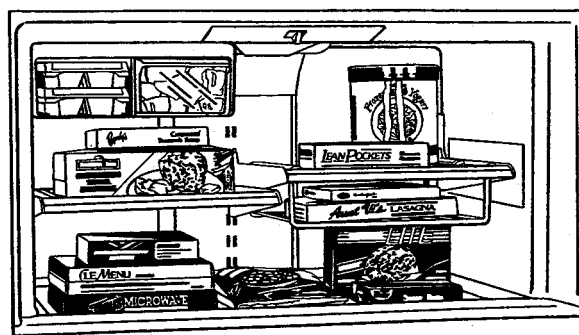

Figure 29

- To remove storage rack, first remove food from rack.
- Hold each end of rack and push rack to right to release rack slot from wire shelf.
- Pull down if located under freezer shelf. Lift up if located above freezer shelf.
- To replace storage rack, position rack on top of or underneath freezer shelf between shelf wires.
- Center slot of rack should be positioned on top of or underneath center wire of freezer shelf.
- Lock into place by pushing rack to left. Be sure round knobs are securely in place. See Figure 30.

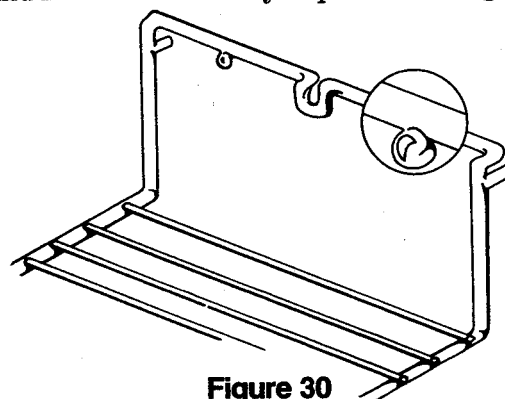

Figure 30

- Rack should not move left or right.

Other Features

Decorator doors

Door fronts of most refrigerators can be decorated with panels to accent your kitchen decor. Trim kits can be purchased separately from your Amana dealer.

- Basic $\frac{1}{16}$ " trim kit attaches to door edges and can accommodate $\frac{1}{16}$ " (1.6 mm) thick panels.
- For panels that are $\frac{1}{4}$ " (6.4 mm) thick, an additional trim kit is required. $\frac{1}{4}$ " kit attaches to panels and slides tongue-in-groove fashion into $\frac{1}{16}$ " (1.6 mm) trim, which must be installed on doors first.
- Ask your Amana dealer about panel availability on special models or you may supply your own panels.
- Amana does not supply custom panels.

Care and Cleaning Of Your Refrigerator

Exterior

- Wash refrigerator cabinet with warm, soapy water as needed.
- Do not use:**
 - Concentrated liquid dishwashing detergent
 - Abrasive cleaners such as COMET, AJAX, etc.
 - Solvents
 - Metal scouring padsThese can cause surfaces to scratch, crack and discolor.

Interior

⚠ CAUTION:
TO AVOID ELECTRICAL SHOCK: Unplug power cord or open household circuit breaker to refrigerator before replacing a burned out light bulb or before cleaning. After cleaning or changing light bulb, reconnect power.

- Wash with warm, soapy water.
- Rinse and dry.
- Do not use** abrasive heavy-duty powders such as AJAX or COMET.
- Avoid metal or abrasive cleaning pads.
- Do not use** concentrated liquid detergent (Dissolve in warm water before using). These cleaners may cause scratching, cracking or discoloration.
- Butter dish, and "second serving" leftover containers can be washed in an automatic dishwasher (top rack). Other parts should be hand washed.

Adhesives

- To remove** glue from stickers and labels placed on inside of refrigerator, dab non-abrasive toothpaste over adhesive.
- Rub the adhesive with fingers and rinse.

Dairy storage door

- Lift door up.
- Place forefingers on either side of door near hinge where dairy door and refrigerator liner connect.
- Flex in slightly.
- Pull out.

Second serving containers

- Containers are microwave safe.
- Follow manufacturer's instructions when using containers to **REHEAT** food in a microwave oven.
- Containers are dishwasher safe. Always place in top rack of dishwasher.
- If containers should stain, follow manufacturer's instructions for cleaning.

Deep door shelves

There are two door shelves on refrigerator door that remove for easy cleaning.

- Grasp each side of retainer.
- Pull shelf straight up. See Figure 32.

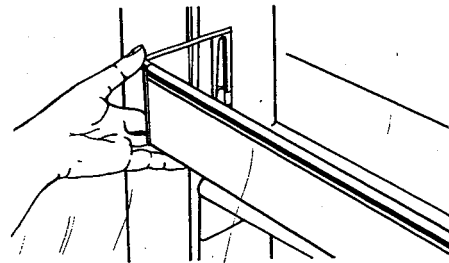

Figure 32

- Then pull out to remove. See Figure 33.

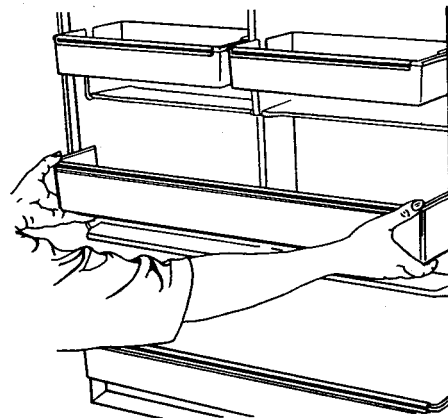

Figure 33

Crisper drawer and shelf removal

Crisper drawers can be removed, even when door is opened at a 90° angle, for easy cleaning.

- Remove food from crisper drawer.
- Remove food from shelves located above crisper drawer and below meat keeper.
- NOTE:** It may be necessary to remove cantilever shelves located above crisper drawers in order to remove bottom glass shelf.
- Open drawer of left* hand crisper.

*For refrigerators hinged on left use crisper on right.

Care and Cleaning Of Your Refrigerator (Cont.)

Odor removal

- Disconnect electrical power plug.
- Remove all food.
- Thoroughly wash inside, including all shelves, drawers, accessories and gaskets, with a mixture of 4 tablespoons of baking soda dissolved in a quart of warm water. Pay special attention to any corners, crevices or grooves into which odor-causing liquids may have seeped.
- Dry thoroughly.
- Return food to refrigerator; washing off all bottles, jars and containers before placing them into refrigerator and freezer.
- Plug in refrigerator. Wait 24 hours before checking to see if odor has been eliminated. If odor is still present, please call the Amana Consumer Information Line toll free (1-800-843-0304) for additional cleaning methods.

Door gaskets

- Clean refrigerator and freezer gaskets at least twice a year with a mild detergent diluted in water.
- Do not** clean with cleaners which contain ammonia or chlorine bleach.
- Rinse and dry.
- Apply a light film of petroleum jelly to gaskets to help keep them soft and pliable.

Mechanical

Condenser coil

It is important to clean condenser coil of any refrigerator every three months. Dust and lint will:

- reduce cooling performance.
 - cause refrigerator to waste energy and
 - shorten life of the compressor and other components.
- Grasp toe grille at each end. Pull forward to remove. See page 5 for location.
 - Use long handled bottle brush and a vacuum cleaner hose nozzle to remove dust and lint from condenser coil at bottom of refrigerator. (A special brush can be purchased from your Amana dealer — part no. R1930-4.)
 - Snap toe grille into place.
 - Additional cleaning may be done if refrigerator is pulled away from wall. Run a vacuum brush across condenser fan outlet grille on lower back of refrigerator.

Light bulb

You will need a 40 watt appliance bulb such as:

Amana #A0282803
GE or Westinghouse #40A15/1
Sylvania #40A15

These can usually be purchased from your appliance dealer or a hardware store.

CAUTION:
TO AVOID ELECTRICAL SHOCK: Unplug power cord or open household circuit breaker to refrigerator before replacing a burned out light bulb or before cleaning. After cleaning or changing light bulb, reconnect power.

- Disconnect power to unit.
- Allow bulb to cool, if hot.
- Wear gloves to protect your hand should the bulb break.
- Unscrew screw at back center of light cover and pull light cover straight down. (There are small supports on each side to hold cover in place that need to release.) See Figure 38.

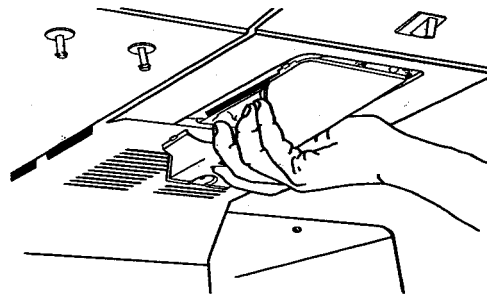

Figure 38

- Unscrew light bulb by rotating bulb counterclockwise.
- Screw new bulb in place, rotating bulb clockwise.
- Snap light cover back in place and return screw back to center back of light cover. See Figure 39.
- Plug in refrigerator.

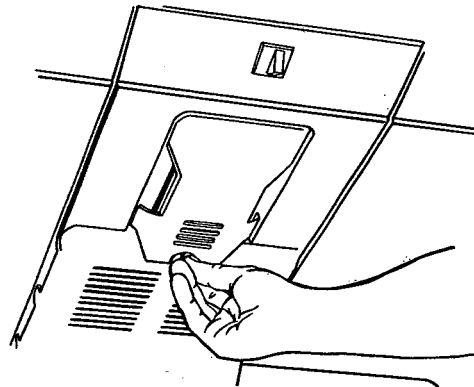

Figure 39

Before Calling For Service:

You may save time and expense of a service call by checking for these common problems **before you call for service.**

<p>Refrigerator does not operate</p>	<ul style="list-style-type: none"> • Does the light work? A dim light indicates low voltage or a weak bulb. • Is the electrical power cord plugged in? • Is a fuse or circuit breaker open? Check by plugging in another appliance or lamp at the same wall outlet. • If the lights work and the freezer control is on, but the two fans and compressor are not operating, the refrigerator is most likely in the defrost cycle. Wait 40 minutes to see if the refrigerator will restart.
<p>If the refrigerator still won't operate</p>	<ul style="list-style-type: none"> • Unplug the refrigerator and take the steps necessary to preserve the food stored in the refrigerator. Dry ice may be placed in the freezer section of the refrigerator to preserve food until the refrigerator can be serviced. Doors should be left closed until the refrigerator has been repaired. Your product warranty does not cover food loss. • If you have questions regarding the steps above, call Amana's Consumer Information Line Toll Free 1-800-843-0304. • Call your nearest Amana dealer or authorized service center listed in the Yellow Pages.
<p>If food temperature appears too warm</p>	<ul style="list-style-type: none"> • See section 1 above. • Have you recently added a large supply of food? Allow adequate time for the food to reach refrigerated freezing temperature. • Is the condenser coil area clean? (See page 14.) • Adjust refrigerator and/or freezer control. (See page 4.)
<p>If the refrigerator has an odor</p>	<ul style="list-style-type: none"> • Clean the inside of your refrigerator/freezer. (See page 12.)
<p>If the Deli Fresh Chiller is too warm</p>	<ul style="list-style-type: none"> • Is the Deli Fresh Chiller positioned in the proper place? (See page 6.) • Slide Deli Fresh Chiller control to a colder setting. • Adjust freezer control to colder setting.
<p>If the refrigerator food temperature is too cold</p>	<ul style="list-style-type: none"> • Is condenser coil area clean? (See page 14.) • Are any wire shelves covered with foil or plastic, preventing proper air flow? • Adjust refrigerator control. (See page 4.) • Adjust freezer control to warmer setting. Allow several hours for temperature to adjust.
<p>If the refrigerator runs too much or too frequently</p>	<ul style="list-style-type: none"> • It may be normal to maintain an even temperature. • Is condenser area clean? (See page 14.) • Have doors been opened frequently or for an extended period of time? • Is freezer running too cold? Adjust freezer control. (See page 4.) • Check door alignment and gasket seal for proper closure.
<p>If the refrigerator makes unfamiliar sounds or seems too noisy</p>	<ul style="list-style-type: none"> • These may be normal operating sounds. Refer to page 11 for information on sounds the unit may make.

Refrigerator Warranty

Owner's Responsibility

- Secure proper installation of the refrigerator through an authorized Amana installer.
- Provide normal care and maintenance.
- Provide proof of purchase (sales receipt or canceled check) upon request.
- Replace light bulbs, shelves, drawers or other owner replaceable items, following instructions in use and care manual.
- Have appliance reasonably accessible for service.

What Is Covered

Full One-Year Warranty

For one year from date of original purchase we will provide, free of charge, parts and service labor in your home to repair or replace **any part of the refrigerator** that fails because of a defect.

Full Five-Year Warranty

For five years from date of original purchase, we will provide, free of charge, parts and service labor in your home to repair or replace **any part of the sealed refrigerating system** (the compressor, condenser, evaporator and all connecting tubing) that fails because of a defect.

We will also repair, free of charge, any defective food compartment liner. The door liner is covered only in the first year.

An automatic icemaker will be considered part of the refrigerator for warranty purposes when purchased with the refrigerator and installed at the factory or by the dealer.

This warranty is for products purchased for ordinary home use in the U.S. and Canada.

However, in Alaska, U.S. territories and Canada, the warranty in the second thru fifth years is **LIMITED** because you must pay to ship the product to the service shop or for the service technician's travel costs to your home.

All warranted service must be performed by an authorized Amana servicer. Service will be provided during normal business hours.

Look in the White or Yellow Pages of your telephone directory for authorized Amana servicers.

What Is Not Covered

- Service trips to your home to teach you how to use the product.

Read your Use and Care Guide. If you then have any questions about operating the product, please contact your dealer or our Consumer Affairs office at:

Amana Refrigeration, Inc.
Amana, Iowa 52204

or call, toll free:

1-800-843-0304

Weekdays, normal business hours.

(Note: Toll free number is only available in the U.S.)

- Improper installation.
If you have an installation problem, contact your dealer or installer. Your dealer or installer is responsible for the correct installation of your refrigerator. You are responsible for providing adequate electrical, and plumbing hookups.
- Replacement of house fuses or resetting of circuit breakers.
- Failure of the product if it is used for other than its intended purpose or if used for other than normal home use.
- Damage to product caused by accident, fire, floods or acts of God.

AMANA REFRIGERATION, INC. IS NOT RESPONSIBLE FOR INCIDENTAL OR CONSEQUENTIAL DAMAGES*.

*Some states do not allow the exclusion or limitation of incidental or consequential damages, so the above limitation or exclusion may not apply to you. This warranty gives you specific legal rights, and you may also have other rights which vary from state to state. To know what your legal rights are in your state, consult your local or state consumer affairs office or your state's Attorney General.

Warranty Exclusions

Temperatures

This refrigerator/freezer is designed to operate in room temperatures no lower than 55°F (13°C). In lower room temperatures the compressor will not run enough to maintain proper refrigerator temperatures. Do not install in an area where room temperatures drop below 55°F (13°C).

Amana Refrigeration, Inc. will not pay warranty claims caused by improper installation.

Removing and Reversing Doors

Contact an authorized professional installer, trained by Amana to:

- Remove refrigerator and freezer doors.
- Reverse doors to change door swing.
- Install ice maker.

