

BQ 20R  
BS 20R  
BX 20R  
BZ 20R  
TA 18S2  
TG 18S3  
TH 18S3  
THI 18S3  
TR 22S4  
TRI 22S4  
TRI 22SR  
TS 18R2  
TV 18S3  
TW 18S2

# Amana®

## Ice Maker for Top Freezer Refrigerators

## Installation and Operating Instructions

### Introduction

---

This kit contains component parts of the Automatic Ice Maker. The wiring diagram label on the back of the refrigerator/freezer identifies the required Ice Maker kit model and manufacturing number.

Read and thoroughly understand this entire instruction manual before starting to install the ice maker kit. Make sure all necessary tools and materials are available to complete the job. Study illustrations to become familiar with this appliance and with important details of the installation procedure.



**CONSUMER INFORMATION LINE  
TOLL FREE  
1-800-843-0304**



**RECOGNIZE THIS  
SYMBOL AS A SAFETY  
PRECAUTION**

Part No. 10527001  
Printed in U.S.A.

**Amana**  
A Raytheon Company

### NOTE

1. **Mechanical experience is required in order to install the ice maker.**
2. Depending on the installer's knowledge and skill, installation can take from three (3) to six (6) hours.
3. **If unable to solve a problem during installation, contact an authorized Amana Servicer. Contact and service is at the owner's expense.**

### IMPORTANT

For both personal safety and to avoid possible damage to appliance or home, observe *all* safety instructions for each topic.

Amana Refrigeration, Inc.  
Amana, Iowa 52204

# Safety Instructions

---

Read and understand the following safety instructions before proceeding with installation.



## WARNING

To avoid the risk of electrical shock, which can cause severe personal injury or death, observe these precautions:

1. **DISCONNECT REFRIGERATOR FROM ITS ELECTRICAL POWER SOURCE.**
2. Use *only* an electric drill that is properly grounded and/or double-insulated.
3. Shut off the water supply and drain the chosen water pipe through a faucet at some low point in the water system *before* drilling into a water pipe.
4. On horizontal water pipes, drill only into the *side* or *top*. Drilling on the underside can allow trapped water to enter the drill and cause electrical shock.



## CAUTION

Failure to observe the following precautions may result in damage to appliance or other property.

1. In preparation for saddle valve installation, use care to drill through only *one* wall of the water pipe.
2. Check carefully for water leaks following installation of the ice maker kit and before returning the refrigerator or freezer to its normal location.
3. Always start tubing nuts *by hand* to avoid cross-threading. Use an adjustable wrench or a 1/2-inch open-end wrench to finish tightening nuts.

# Installation Materials Needed

---

Use all parts furnished with the ice maker kit. Select a suitable cold water pipe (vertical preferred) for installation of the saddle valve, and **purchase** enough 1/4-inch flexible copper tubing to reach between the chosen water pipe and the rear of the refrigerator, **plus an additional eight (8) feet** to allow for servicing. The ends of this flexible tubing must be free of cutting burrs.

## NOTE

If the household water supply contains sand or sediment or an objectionable taste, a disposable activated-carbon water filter can be installed in the water line supplying the ice maker. The filter is *not* included with the ice maker kit. Consult your appliance dealer for availability.

## Recommended Tools

---

To properly and conveniently install the ice maker kit, use the following basic tools.

- Center punch
- Hammer
- Electric drill (ground fault protected)
- 1/4-inch drill bit
- 3/8-inch drill bit
- 1/4-inch hex socket and driver
- Needle-nose pliers
- Adjustable wrench
- One 1/2-inch open-end wrench
- One 3/8-inch open-end wrench
- Flat-blade screwdriver
- Small knife
- Masking tape
- Tightly-fitted gloves

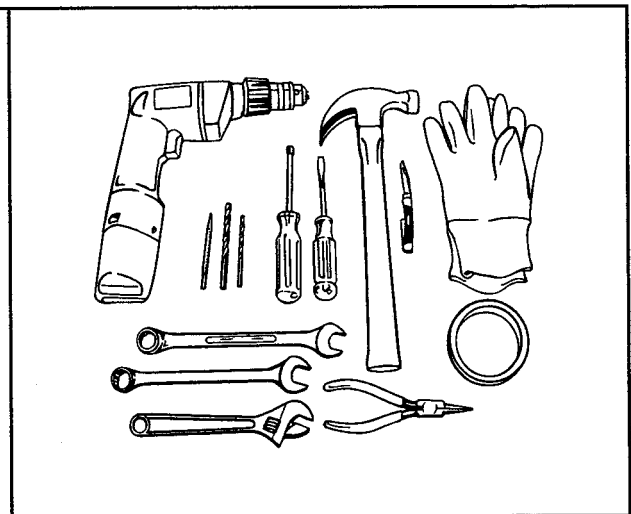
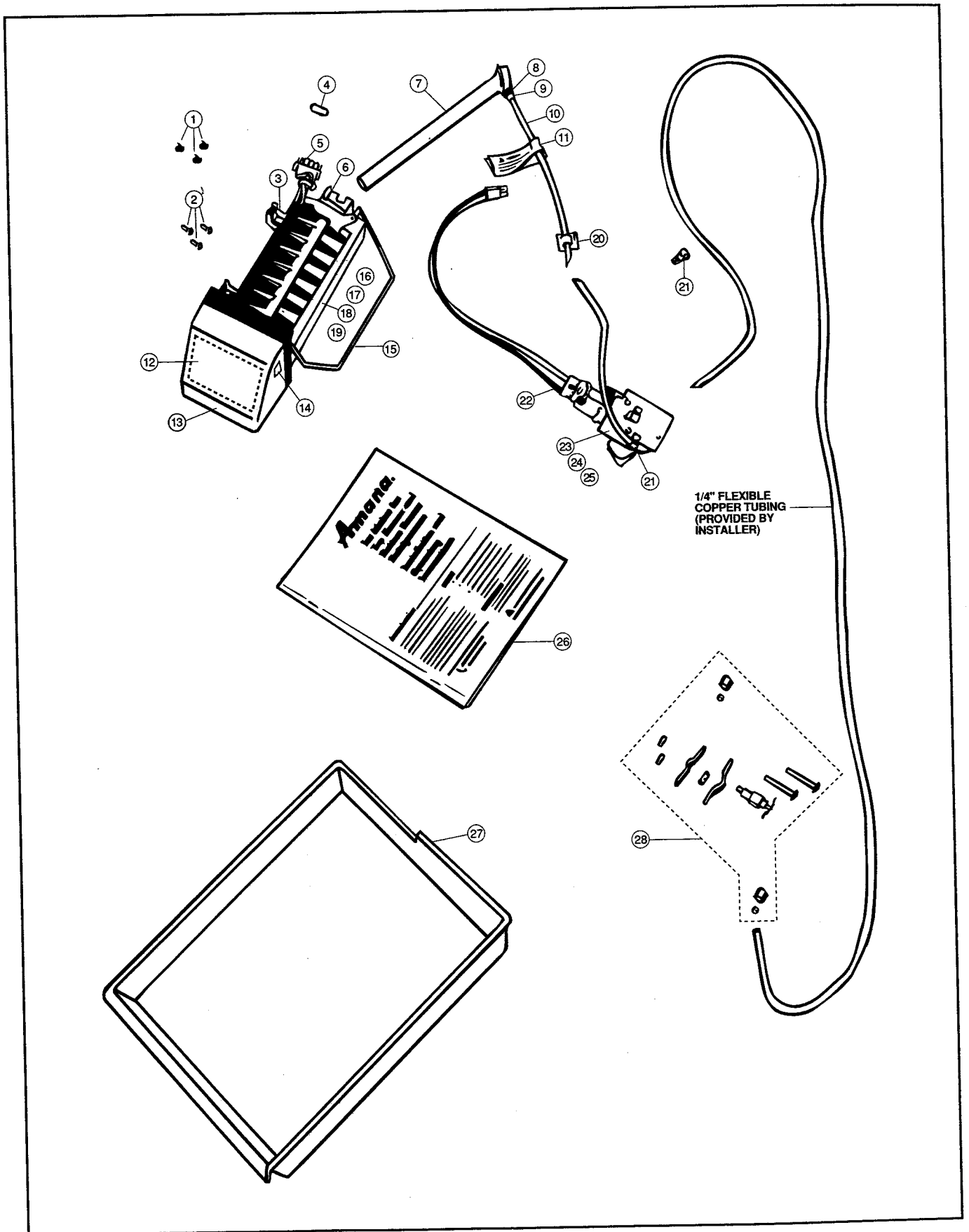

Figure 1

Refer to Item Number on the Parts List for Description, Part Number and Quantity



**NOTE: Use Only Supplied Parts**  
(except for 1/4-inch flexible copper tubing, supplied by installer)

# *Ice Maker Parts List*

## *Model IC6*

---

Use parts list **only** for ordering. Part numbers are **not** used for installation.

ITEM	DESCRIPTION	PART NUMBER	QUANTITY
1	Button Plug (to seal ice service holes)	M0311301	3
2	5/8" Sheet Metal Screw (ice maker to liner)	M0211018	3
3	Clamp (ice maker wire harness)	10526701	1
4	Double Prong Hole Plug (1-upper back freezer cover, 4-bottom freezer shelf slots; oblong white plastic)	A3124301	5
5	Wire Harness (attached to ice maker)	D7813004	1
6	Stainless Steel Clip (attached to ice maker water inlet cup)	B5720301	1
7	Water Fill Tube Elbow	10463201	1
8	Clip Speed (secures 1/4" plastic tube at water fill tube elbow)	M0114003	1
9	Stainless Steel Tube Insert (inside 1/4" plastic tube at water fill tube elbow)	A3223101	1
10	1/4" O.D. Plastic Tube (connects water fill tube and water valve)	B5705308	1
11	Label (attached to plastic tube by water fill tube elbow and water valve)	10549601	2
12	Diagnostic Label (attached inside ice maker front cover)	C8979501	1
13	Ice Maker Cover (attached to ice maker)	10519801	1
14	Warning Label (attached to side of ice maker cover)	A3036901	1
15	Shut-off Arm (attached to ice maker)	D7813101	1
16	Ice Maker	D7824702	1
17	Lower Mounting Bracket (attached to ice maker)	B8391801	1
18	3/8" Sheet Metal Screw (secures lower ice maker bracket and copper tube "P" clamp at valve)	M0211116	2
19	Clip-Thermal Fuse (attached to ice maker)	10319801	1
20	Plastic Clamp (secures 1/4" plastic tube to back)	M0104101	1
21	"P" Clamp (secures 1/4" copper tube at water valve)	M0102301	2
22	Wire Harness (connects water valve to terminal board)	10525901	1
23	Water Valve	10524601	1
24	Nylon Nut and Sleeve (connects 1/4" plastic tube to water valve)	M0753001	1
25	Anti-kink Spring (inside 1/4" plastic tube at water valve)	A1055101	1
26	Installation Instructions	10527001	1
27	Ice Cube Pan	10476201	1
28	Saddle Valve Assembly (in plastic bag)	10561801	1

## *Kit Installation Procedure*

---

For best results, perform the installation procedure in the order presented, to minimize the time the refrigerator must be disconnected and the household water supply shut off.

Unless otherwise stated, all parts shown in these instructions are contained in the ice maker kit.

1. Install the water supply saddle valve and connect the 1/4-inch flexible copper tubing (*provided by installer*):
  - a. Shut off the household water supply at the main water valve.
  - b. At some low point in the water system, open a cold water faucet and allow the water system to drain until water no longer flows from the faucet.
  - c. On the chosen cold water pipe (vertical preferred), select a spot and mark it exactly with a center punch and hammer.
  - d. Drill a 1/4-inch hole at the marked spot, drilling through *one* side wall (vertical pipe) or the top (horizontal pipe) of the chosen pipe, as appropriate.  
**Use care to avoid drilling through the opposite wall of the pipe.**

## NOTE

Use *only* the saddle valve supplied with the ice maker kit, or an identical valve. Do *not* use a self-piercing valve. Self-piercing valves make a hole in the pipe that is smaller than a drilled hole; water pressure is reduced and water flow to ice maker may be restricted.

- e. Attach the saddle valve to the water pipe, using the parts illustrated in Figure 2.
- Thread the valve to the saddle valve clamp. The saddle valve clamp *must* be threaded onto the saddle valve stem *before* securing the saddle valve to the water pipe. The valve will *not* thread completely into the saddle valve clamp because the threads are tapered.
  - Place the rubber washer between the saddle valve clamp and the water pipe.
  - Tighten the two (2) bolts and two (2) nuts evenly, in increments, so spacing between both sides of the clamp remains equal.
  - **Do not over-tighten.**

- f. Slip the brass nut and brass sleeve onto the 1/4-inch flexible copper tubing, as shown in Figure 2.

- g. Insert the 1/4-inch copper tube *completely* into the saddle valve outlet port. Be sure to start the nut *by hand*, turning clockwise, to avoid cross-threading. Use a 1/2-inch open-end wrench to firmly connect the brass nut on the copper tubing to the saddle valve outlet port fitting. **Tug on the tubing to check that it is secured to the coupling.**

***Do not over-tighten.***

- h. Shut off the saddle valve by rotating the handle fully clockwise. Turn on the household water supply valve.
- i. Before proceeding, be sure there are no leaks in the connections, and that the saddle valve completely shuts off the water supply.

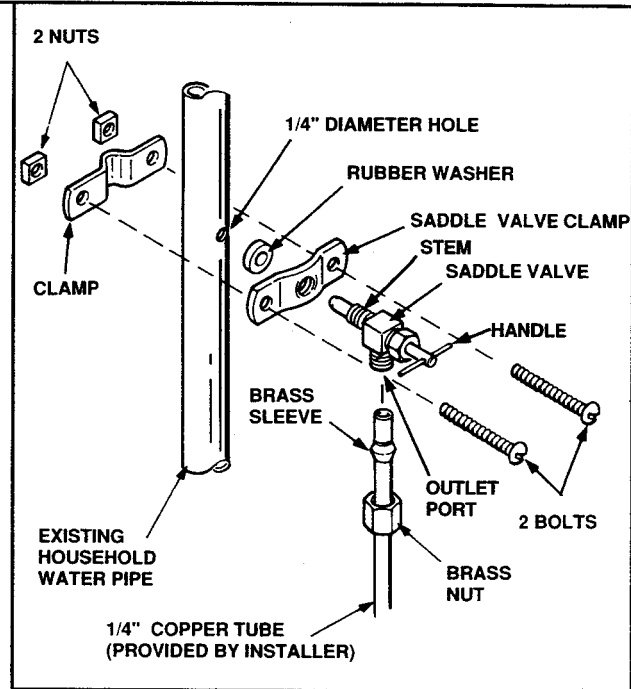

Figure 2

## NOTE

Protect the floor under the wheels when moving the refrigerator.

2. Route the flexible copper tubing to the refrigerator and flush the saddle valve and tubing.
  - a. Unplug the refrigerator power cord from its electrical outlet.
  - b. Pull the refrigerator away from the wall, making sure the back is accessible.
  - c. Drill 3/8-inch holes for openings in the floor or the interior house wall behind the refrigerator, as appropriate, to allow the copper tubing to pass through easily.
  - d. Route the copper tubing to the refrigerator and put the open end into a nearby sink or pail. Open the saddle valve slightly. *Remember that the water will be under pressure.*
  - e. Allow the water to run through the copper tube for several minutes to flush the saddle valve and the tube. When flushing is completed, shut off the saddle valve.
3. Remove the freezer shelf.
  - a. For a two-position full-width shelf and divider rack, first reposition or remove the rack by pressing down on the center rod, while sliding it to the rear and tipping it to one side.  
  
Next, lift the entire shelf slightly, while sliding one end into the upper channel. Tip the other end of the shelf out of its channel and remove it from the freezer compartment.
  - b. For adjustable cantilever shelves, slightly raise the back to disengage holding hooks. Lift up on the shelf to remove.



4. Remove ice rack from left rear wall of freezer compartment.

- a. Remove the ice cube trays from the ice rack.
- b. Tug gently forward on the rack to free it from the three (3) holding screws, as shown in Figure 3.
- c. Use the 1/4-inch hex socket and driver to remove and discard the ice rack holding screws. Push two (2) white button plugs into the screw holes.

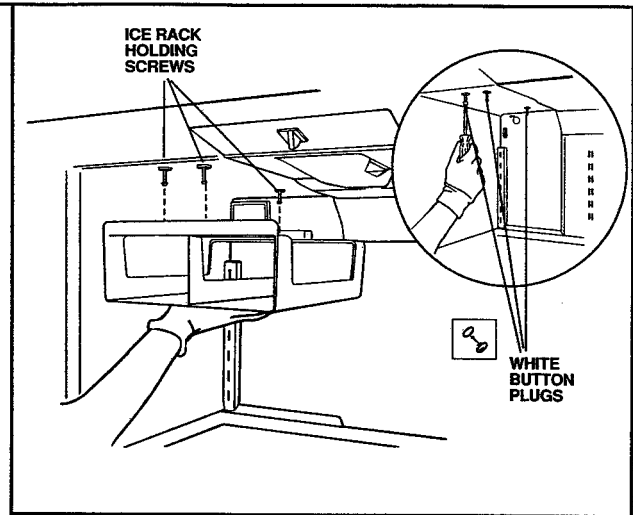

Figure 3

5. Remove the cover plate for electrical and water connection.

- a. Use the 1/4-inch hex socket and driver to remove the screw that attaches the cover to left rear interior wall. See Figure 4.
- b. Discard the screw and the cover.

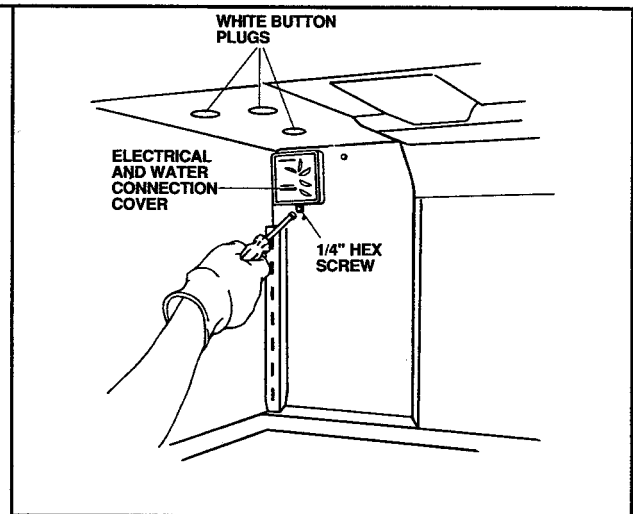

Figure 4

6. Push in a double-prong plug to seal the cover mounting slot. See Figure 5.

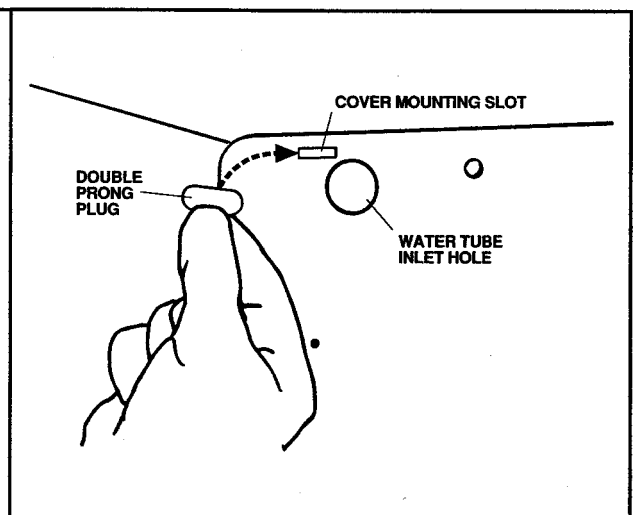

Figure 5

7. Use oblong white plastic double-prong plugs to place freezer shelf in proper position for the ice storage bin. Freezer shelves must be installed correctly to insure proper operation of the ice maker.

a. On refrigerators with adjustable freezer shelves, push four (4) double-prong plugs into the two lowest shelf slots, two at left side ladder and two at center ladder. See Figure 6.

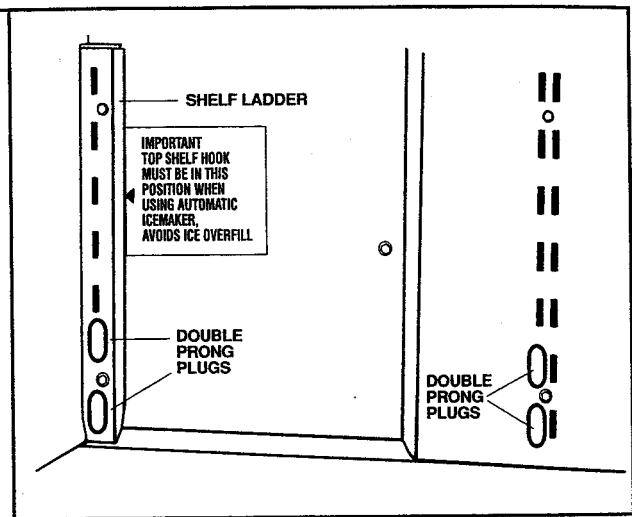

Figure 6

b. On refrigerators with an adjustable full-width freezer shelf, push one (1) oblong white plastic double-prong plug into the lowest shelf slot at each end of the ladder. See Figure 7.

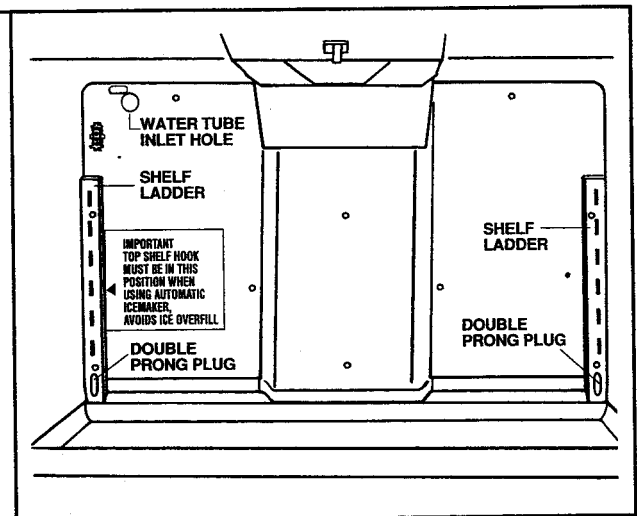

Figure 7

8. Using a small sharp knife, cut out the sealing tape from the water tube inlet hole on the back interior wall of the freezer compartment. See Figure 8.

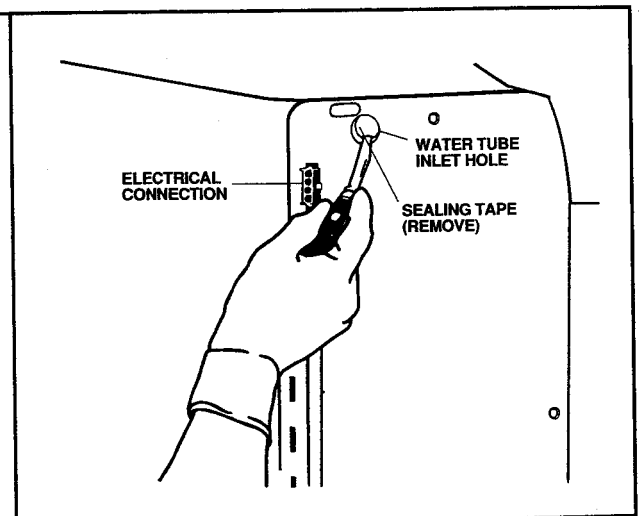

Figure 8

9. Cover the flat-blade screwdriver with masking tape to protect the exterior rear surface of the refrigerator cabinet. Remove the plug for the water tube inlet hole. See Figure 9.

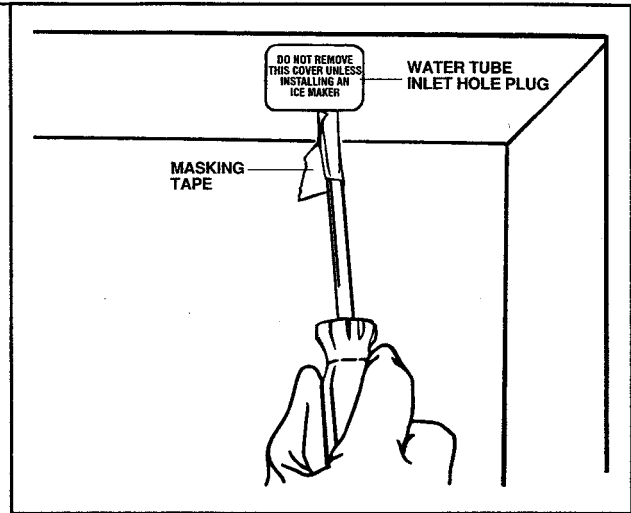

Figure 9

10. To prevent styrofoam insulation beads from entering the water fill tube during installation, temporarily cover the end of the tube with masking tape.

Install the water fill tube by pushing it through the "U"-shaped hole in the exterior rear wall of the cabinet. See Figure 10.

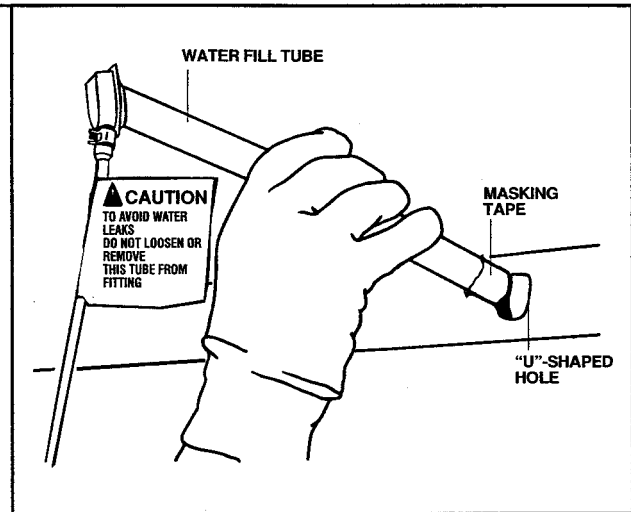

Figure 10

- a. From inside the freezer compartment, pull the water fill tube through the hole in the interior rear wall. See Figure 11.

Be sure to remove masking tape from the end of the water fill tube to allow water to flow into the ice maker.

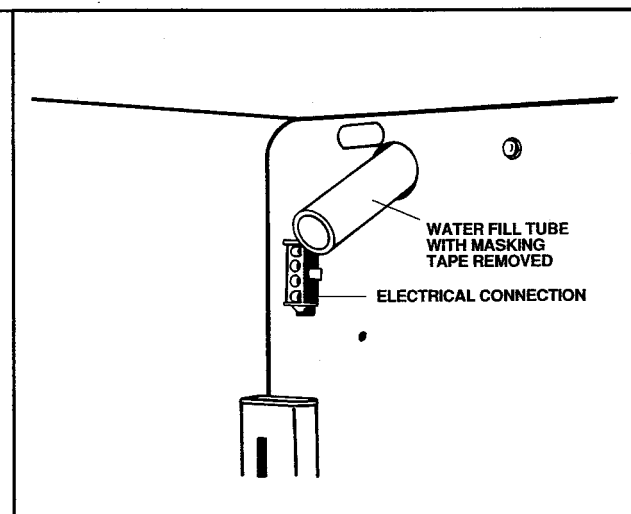

Figure 11

- b. Push gently on the water fill tube while twisting it slightly, until the flange is firmly seated inside the "U"-shaped hole on the exterior rear of the cabinet. See Figure 12.
- c. Check the exterior rear cabinet to be sure the water fill tube is completely sealed. See Figure 12.

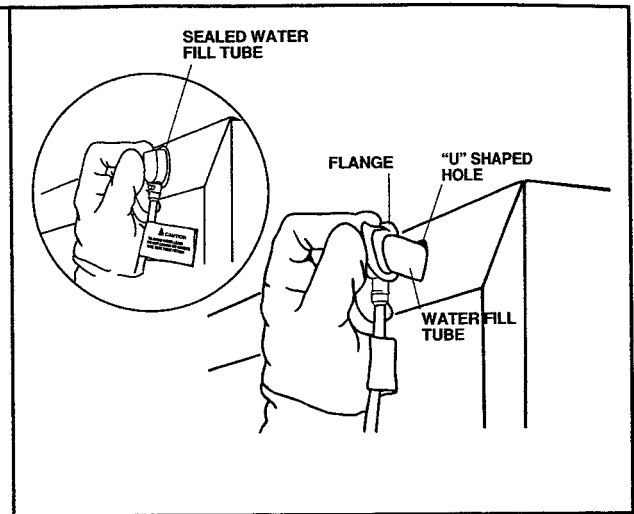

Figure 12

11. Assemble and install the ice maker.

- a. Remove the ice maker from the shipping carton and discard the packing material.
- b. Slip the stainless steel clip over the wall of the water cup. See Figures 13 and 14.

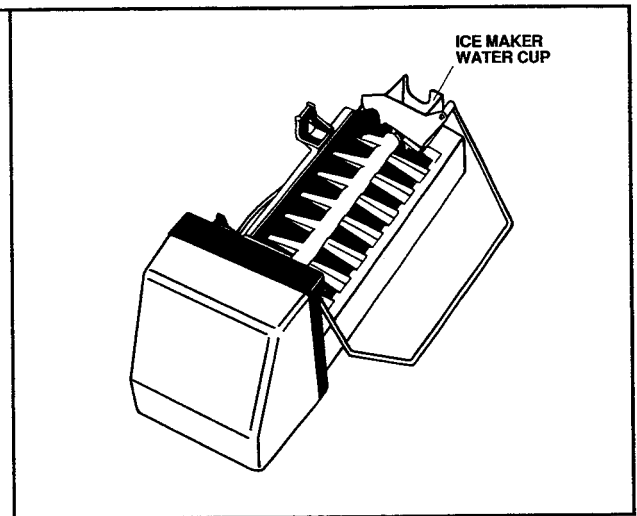

Figure 13

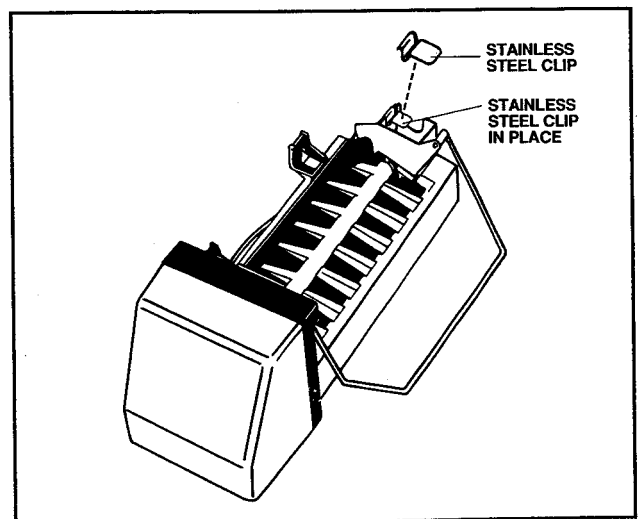

Figure 14

- c. Cover the tip of a knife blade with masking tape to protect the interior surface. Carefully pry out and discard the three (3) white plastic buttons from the left side of the interior freezer wall. See Figure 15.
- d. Start one 5/8-inch silver-colored ice maker mounting screw in the top front hole on the left interior wall of the freezer. Leave the head out approximately 3/8-inch for the slot in the ice maker hanger to slip over the screw.

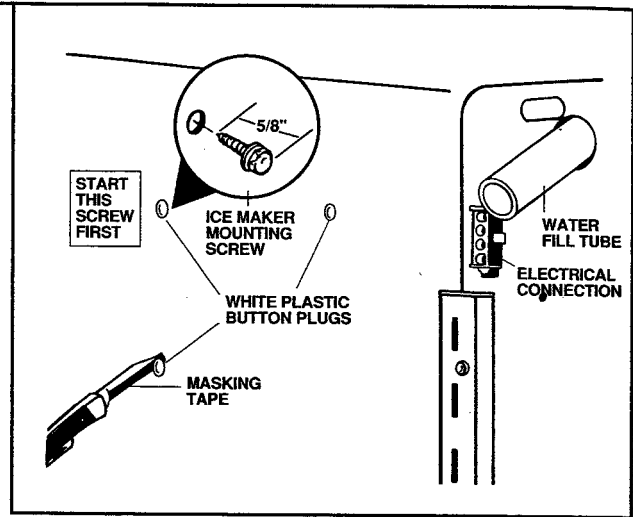

Figure 15

- e. Hold the ice maker in position inside the freezer compartment. Insert the wire harness plug into the receptacle on the rear wall, using a rocking motion, until the locking fingers on the top and bottom of the plug snap into place. See Figure 16.
- f. Slip the ice maker hanger over the mounting screw, while easing the ice maker water cup toward the end of the water tube that extends through the rear wall into the freezer compartment. The water tube extension fits under the stainless steel clip on the water cup. **The water tube must not be kinked. The water tube should extend approximately 3/8-inch into the water cup and must not become easily dislodged.**
- g. Install the two (2) remaining 5/8-inch silver-colored ice maker mounting screws and tighten all three screws.

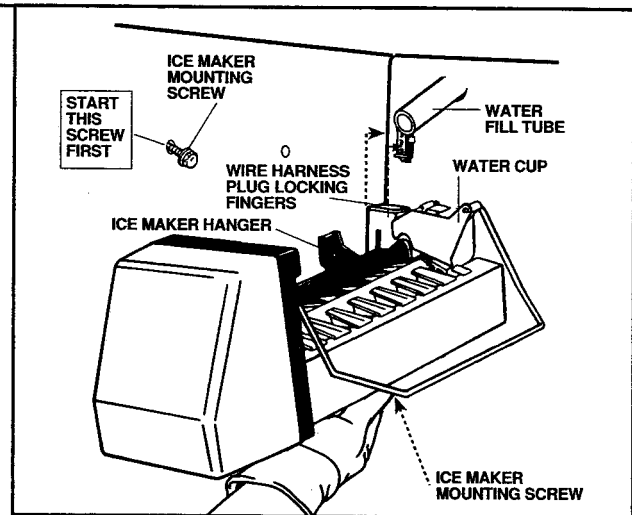

Figure 16

12. The ice maker is shipped from the factory with the shut-off arm in the *down* position, as shown in Figure 17. This is the correct position for ice making.

Do **not** force the arm up or down past the STOP positions.

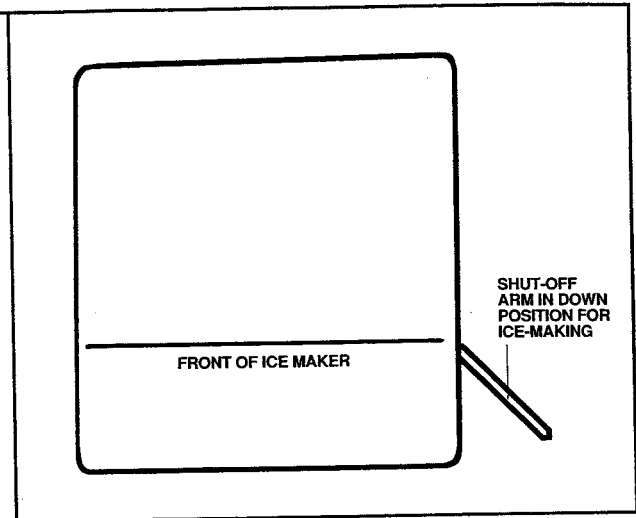

Figure 17

13. Re-install the freezer shelf/shelves. Shelves **must** be installed correctly to insure proper operation of the ice maker.

14. Position the ice storage bin under the ice maker on the freezer shelf, as shown in Figures 18 and 19, to avoid overfilling the bin. Close the freezer door.

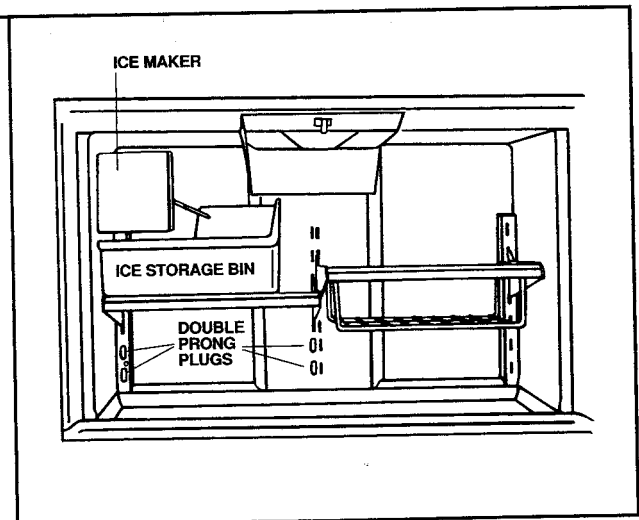

Figure 18

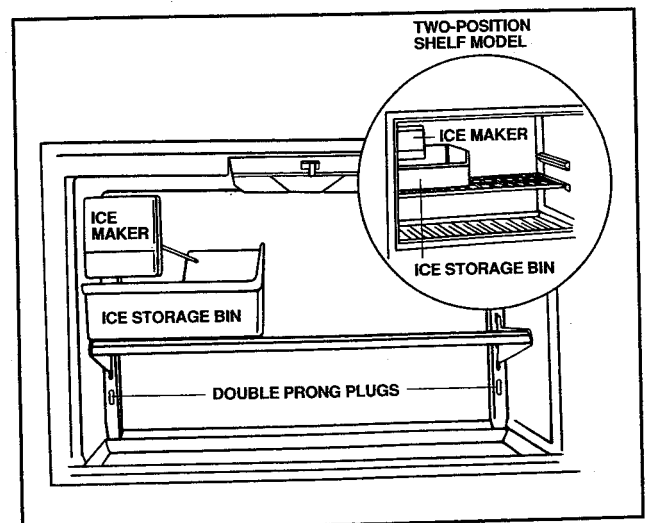

Figure 19

15. Install the water valve.

- a. Remove and retain four screws and the lower half of the vertical wire-and-tube cover from the exterior rear wall of the refrigerator. See Figure 20.

From the upper half of the vertical wire-and-tube cover, remove and retain only the two bottom screws. Do not remove the upper half of the cover. Save all screws for re-assembly.

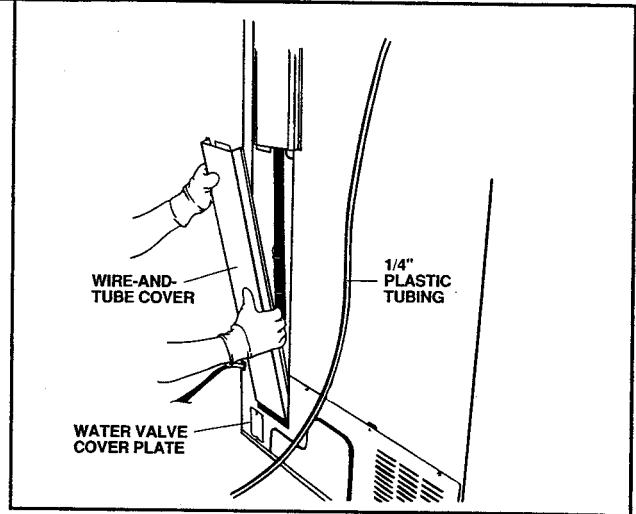

Figure 20

- b. Remove and save the two (2) screws from the water valve cover plate. See Figure 21. Discard the water valve cover plate.

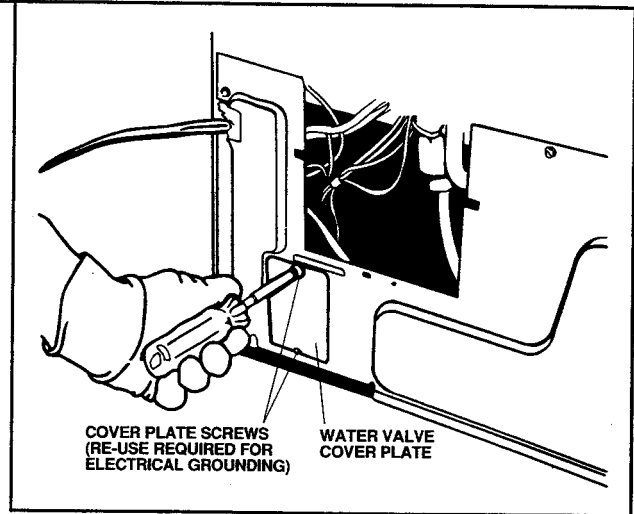

Figure 21

- c. Thread the water valve wires through the rectangular opening, as shown in Figure 22, taking care not to bend any existing tubes.

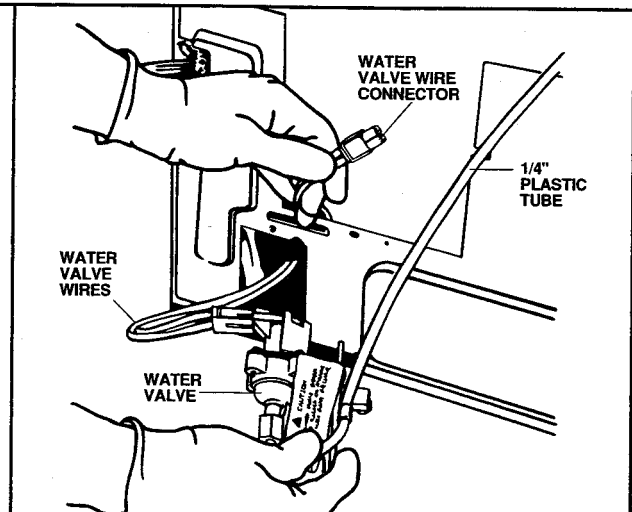

Figure 22

- d. To insure the water valve is electrically grounded, reuse of the two (2) screws saved when removing the water valve cover plate *is required*. Secure the water valve to the cabinet frame by reusing the cover plate screws. See Figure 23.

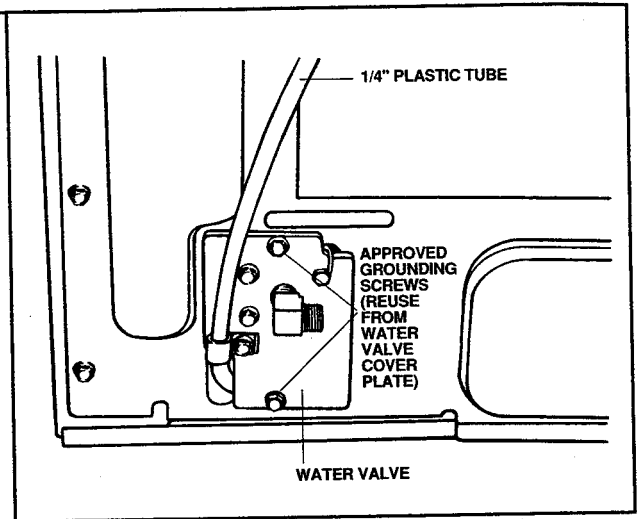

Figure 23

- e. Plug the water valve wire connector into the terminal board at the points on the top left position, marked "1" and "2," across from "A" and "B." See Figure 24.

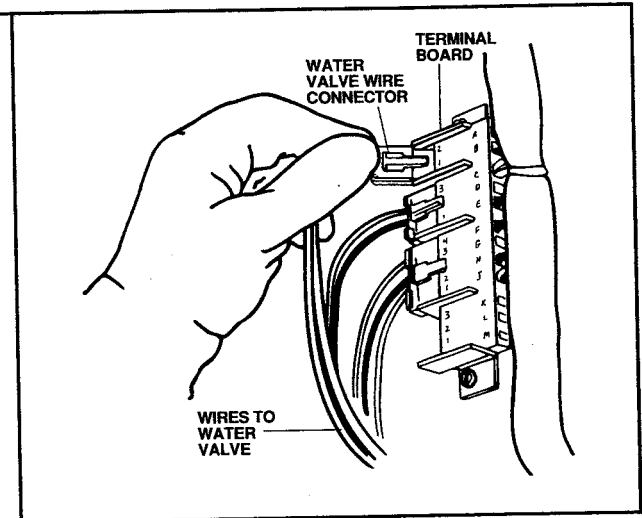

Figure 24

- f. Remove yellow plastic cap on water valve before connecting the 1/4-inch flexible copper tubing service loop (*provided by installer*) to the water valve with a 1/4-inch tube compression nut and sleeve. See Figure 25.

Insert the 1/4-inch copper tube *completely* into the water valve outlet port. Be sure to start the nut *by hand*, turning clockwise, to avoid cross-threading. Use 1/2-inch and 3/8-inch open-end wrenches to firmly connect the brass nut on the copper tubing to the water valve outlet port fitting. **Tug on the tubing to check that it is secured to the coupling.**

***Do not over-tighten.***

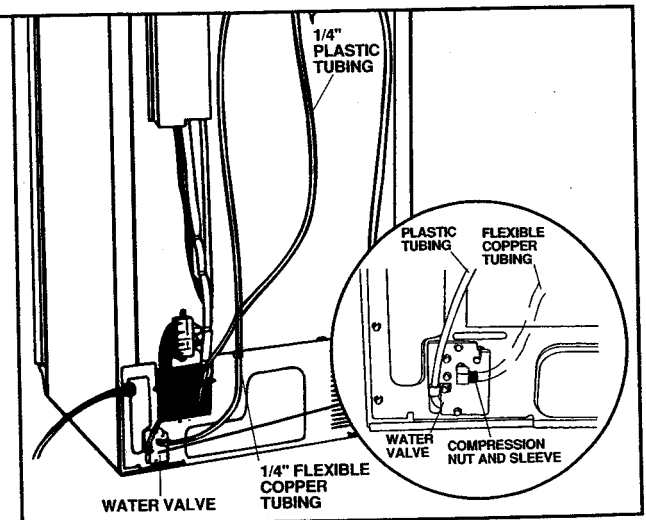

Figure 25



g. Open the saddle valve on household water supply one turn counter-clockwise to check for water leaks. Turn off the saddle valve before correcting any leaks. Repeat this process until no leaks are found; then, completely open the saddle valve.

h. Re-install the lower half of the vertical wire-and-tube cover on exterior rear surface of the cabinet. To avoid pinching wires, carefully tuck the wires inside the cover. Secure the covers by reusing *all* original screws. See Figure 26.

**i. IMPORTANT**

Secure the 1/4-inch flexible copper tubing with the "P" clamp at the back horizontal cover, using the existing cover screw. See Figure 26.

j. Secure the 1/4-inch flexible plastic tubing to the rear wall of the refrigerator cabinet using the plastic stick-on clamp. See Figure 26.

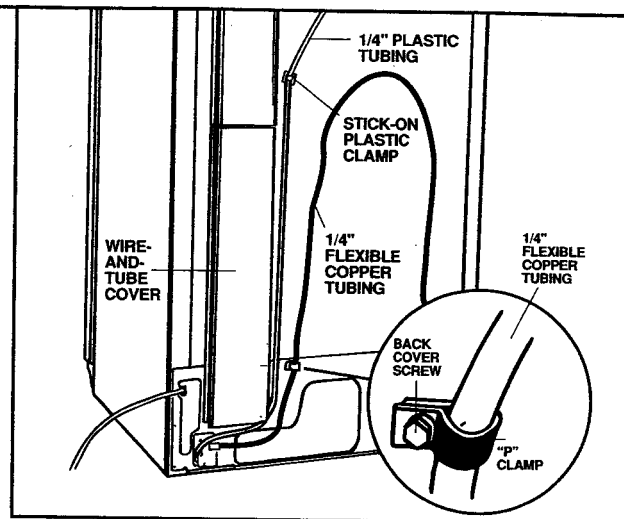

Figure 26



**CAUTION**

All covers *must* be in place for proper operation and safety.

16. Plug the electrical power cord into the wall receptacle.
17. Return the refrigerator to its normal operating location. Turn the freezer control on and set it at the middle position.

# Ice Maker Operation

1. The ice storage bin must be in place; the ice maker shut-off arm must be in the *down* position; the saddle valve must be completely open (turned counter-clockwise).
2. Once the freezer reaches normal temperature, the ice maker will fill with water and ice cubes will be produced.
3. After ice cubes are formed, they are lifted out of the icemaker and dropped into the ice storage bin. Ice-making continues until the storage bin is filled. During each ice-making cycle, the shut-off arm raises and lowers. When the ice bin is full, the shut-off arm senses the accumulation of ice and automatically turns the ice maker off.

## NOTE

The first *three* harvests of ice should be discarded, since they may contain contaminants from the ice maker or from the water system.

4. To stop ice maker operation at any time, gently raise the shut-off arm to the OFF position. See Figure 27. *Do not force the arm up.*



### CAUTION

To avoid damage to the ice maker, do *not* raise the shut-off arm past the maximum position. See Figure 27.

5. As the ice maker operates, the normal sounds of the motor, water running into the ice cube molds, ice cube ejector, and ice cubes dropping into the ice storage bin will be heard.



### CAUTION

Before leaving on vacation or for extended periods of time, turn off the water supply to the ice maker at the saddle valve, and raise the ice maker shut-off arm to the upper position. Failure to take these precautions may result in property damage.

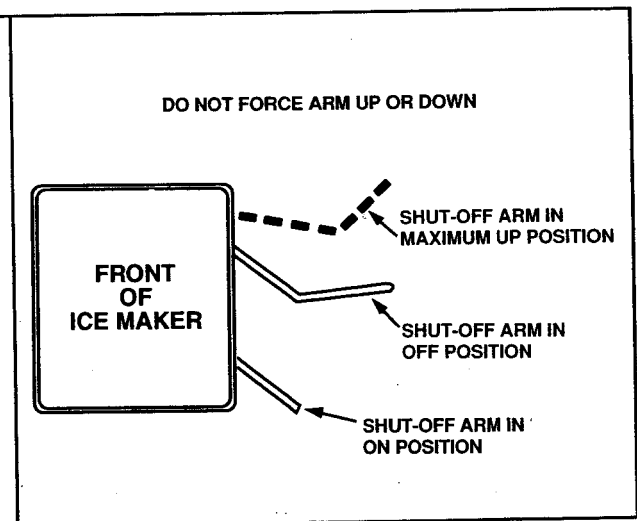

Figure 27

# Ice Maker Service Checks

---

If the preceding installation instructions are followed carefully, there is little chance that the ice maker will fail to function properly. In general, give the ice maker one (1) overnight period before assuming that a problem exists. In the event the ice maker does not operate properly, the following checks should be made by you, the owner, before contacting an authorized Amana Servicer.

## NOTE

The ice maker is designed to produce up to six (6) pounds of ice in a 24-hour period during normal operation.



## WARNING

To avoid the risk of electrical shock, which can cause severe personal injury or death, **DISCONNECT THE REFRIGERATOR FROM ITS POWER SOURCE** before attempting disassembly.

## CHECKPOINTS

1. The saddle valve installed in the household water supply system and water pipe must be fully open (handle completely counter-clockwise).
2. The ice maker wiring harness plugs must be fully seated into the proper holes in the receptacle at the rear of the interior freezer compartment.
3. The flexible copper tubing and the plastic water tube must be free of kinks which could block the flow of water to the ice maker. Remove the kinks or replace the kinked tube(s), as appropriate.
4. The plugs for the electrical connections to the water valve coil and terminal must be tightly seated into all terminals. Remove the lower half of the vertical rear wire-and-tube cover from the refrigerator to check the connections. See Figure 20. *Replace the lower half of the vertical rear wire-and-tube cover before returning the refrigerator to normal use. The refrigerator will not operate properly with any cover removed.*

IC6

# Amana®

## Ice Maker for Bottom Freezer Refrigerators

## Installation and Operating Instructions

### *Introduction*

---

This kit contains component parts of the Automatic Ice Maker. The wiring diagram label on the back of the refrigerator/freezer identifies the required Ice Maker kit model and manufacturing number.

Read and thoroughly understand this entire instruction manual before starting to install the ice maker kit. Make sure all necessary tools and materials are available to complete the job. Study illustrations to become familiar with this appliance and with important details of the installation procedure.



**CONSUMER INFORMATION LINE  
TOLL FREE  
1-800-843-0304**



**RECOGNIZE THIS  
SYMBOL AS A SAFETY  
PRECAUTION**

### **NOTE**

1. **Mechanical experience is required in order to install the ice maker.**
2. Depending on the installer's knowledge and skill, installation can take from three (3) to six (6) hours.
3. **If unable to solve a problem during installation, contact an authorized Amana Servicer. Contact and service is at the owner's expense.**

### **IMPORTANT**

For both personal safety and to avoid possible damage to appliance or home, **observe all safety instructions for each topic.**

# Safety Instructions

---

Read and understand the following safety instructions before proceeding with installation.



## WARNING

To avoid the risk of electrical shock, which can cause severe personal injury or death, observe these precautions:

1. **DISCONNECT REFRIGERATOR FROM ITS ELECTRICAL POWER SOURCE.**
2. Use *only* an electric drill that is properly grounded and/or double-insulated.
3. Shut off the water supply and drain the chosen water pipe through a faucet at some low point in the water system *before* drilling into a water pipe.
4. On horizontal water pipes, drill only into the *side* or *top*. Drilling on the underside can allow trapped water to enter the drill and cause electrical shock.



## CAUTION

Failure to observe the following precautions may result in damage to appliance or other property.

1. In preparation for saddle valve installation, use care to drill through *only one* wall of the water pipe.
2. Check carefully for water leaks following installation of the ice maker kit and before returning the refrigerator or freezer to its normal location.
3. Always start tubing nuts *by hand* to avoid cross-threading. Use an adjustable wrench or a 1/2-inch open-end wrench to finish tightening nuts.

# Installation Materials Needed

---

Use all parts furnished with the ice maker kit. Select a suitable cold water pipe (vertical preferred) for installation of the saddle valve, and **purchase** enough 1/4-inch flexible copper tubing to reach between the chosen water pipe and the rear of the refrigerator, **plus an additional eight (8) feet** to allow for servicing. The ends of this flexible tubing must be free of cutting burrs.

## NOTE

If the household water supply contains sand or sediment or an objectionable taste, a disposable activated-carbon water filter can be installed in the water line supplying the ice maker. The filter is *not* included with the ice maker kit. Consult your appliance dealer for availability.

## Recommended Tools

To properly and conveniently install the ice maker kit, use the following basic tools.

- Center punch
- Hammer
- Electric drill (ground fault protected)
- 1/4-inch drill bit
- 3/8-inch drill bit
- 1/4-inch hex socket and driver
- Needle-nose pliers
- Adjustable wrench
- One 1/2-inch open-end wrench
- One 3/8-inch open-end wrench
- Flat-blade screwdriver
- Small knife
- Masking tape
- Tightly-fitted gloves

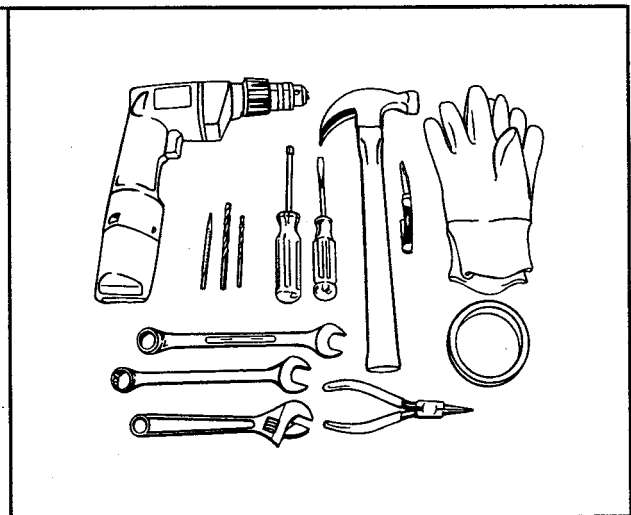
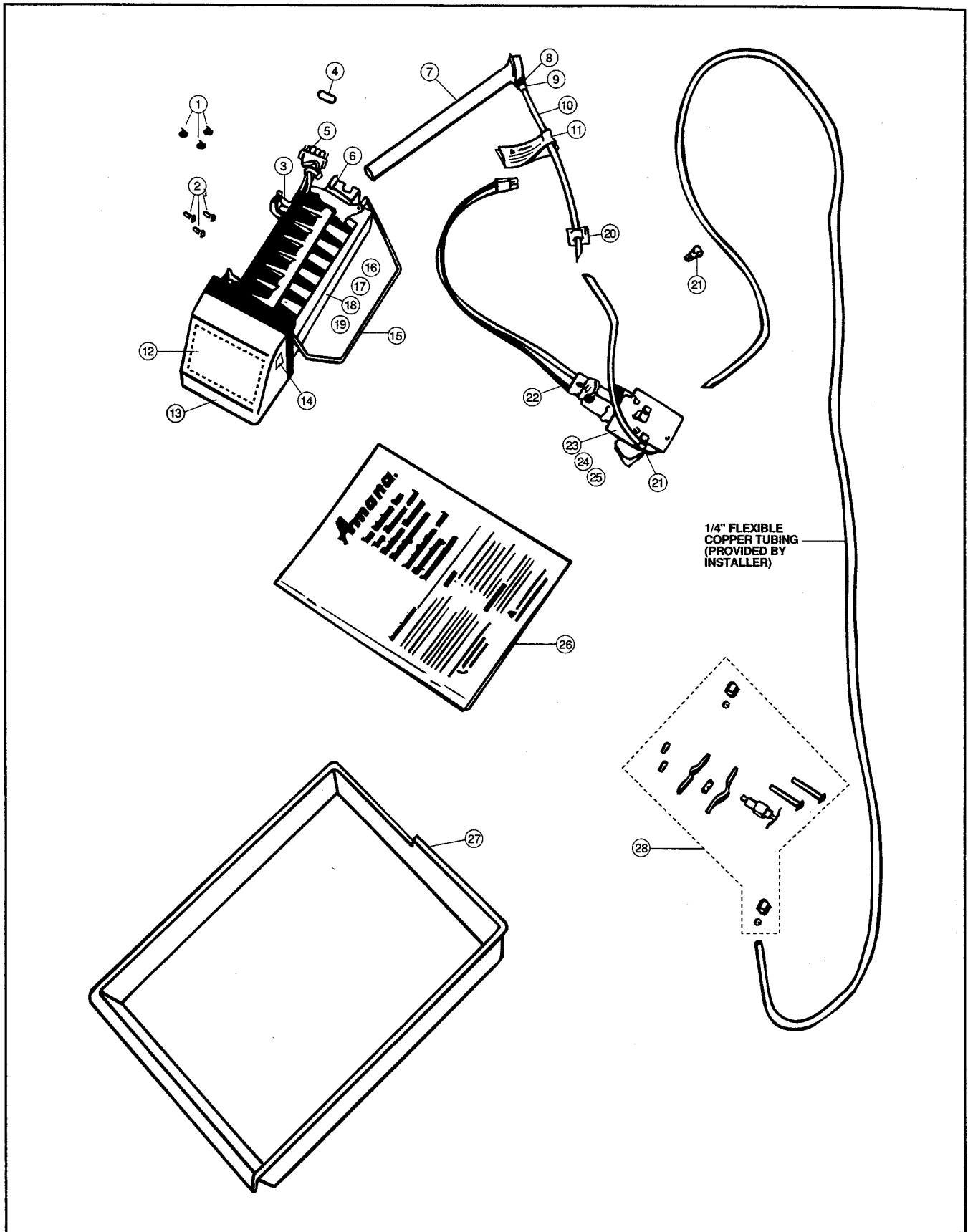

Figure 1

Refer to Item Number on the Parts List for Description, Part Number and Quantity



**NOTE: Use Only Supplied Parts**  
(except for 1/4-inch flexible copper tubing, supplied by installer)

# *Ice Maker Parts List*

## *Model IC6*

---

Use parts list **only** for ordering. Part numbers are **not** used for installation.

ITEM	DESCRIPTION	PART NUMBER	QUANTITY
1	Button Plug (to seal ice service holes)	M0311301	3
2	5/8" Sheet Metal Screw (ice maker to liner)	M0211018	3
3	Clamp (ice maker wire harness)	10526701	1
4	Double Prong Hole Plug (1-upper back freezer cover, 4-bottom freezer shelf slots; oblong white plastic)	A3124301	5
5	Wire Harness (attached to ice maker)	D7813004	1
6	Stainless Steel Clip (attached to ice maker water inlet cup)	B5720301	1
7	Water Fill Tube Elbow	10463201	1
8	Clip Speed (secures 1/4" plastic tube at water fill tube elbow)	M0114003	1
9	Stainless Steel Tube Insert (inside 1/4" plastic tube at water fill tube elbow)	A3223101	1
10	1/4" O.D. Plastic Tube (connects water fill tube and water valve)	B5705308	1
11	Label (attached to plastic tube by water fill tube elbow and water valve)	10549601	2
12	Diagnostic Label (attached inside ice maker front cover)	C8979501	1
13	Ice Maker Cover (attached to ice maker)	10519801	1
14	Warning Label (attached to side of ice maker cover)	A3036901	1
15	Shut-off Arm (attached to ice maker)	D7813101	1
16	Ice Maker	D7824702	1
17	Lower Mounting Bracket (attached to ice maker)	B8391801	1
18	3/8" Sheet Metal Screw (Secures lower ice maker bracket and copper tube "P" clamp at valve)	M0211116	2
19	Clip-Thermal Fuse (attached to ice maker)	10319801	1
20	Plastic Clamp (secures 1/4" plastic tube to back)	M0104101	1
21	"P" Clamp (secures 1/4" copper tube at water valve)	M0102301	2
22	Wire Harness (connects water valve to terminal board)	10525901	1
23	Water Valve	10524601	1
24	Nylon Nut and Sleeve (connects 1/4" plastic tube to water valve)	M0753001	1
25	Anti-kink Spring (inside 1/4" plastic tube at water valve)	A1055101	1
26	Installation Instructions	10527001	1
27	Ice Cube Pan	10476201	1
28	Saddle Valve Assembly (in plastic bag)	10561801	1



# Kit Installation Procedure

For best results, perform the installation procedure in the order presented, to minimize the time the refrigerator must be disconnected and the household water supply shut off.

Unless otherwise stated, all parts shown in these instructions are contained in the ice maker kit.

1. Install the water supply saddle valve and connect the 1/4-inch flexible copper tubing (*provided by installer*):

a. Shut off the household water supply at the main water valve.

b. At some low point in the water system, open a cold water faucet and allow the water system to drain until water no longer flows from the faucet.

c. On the chosen cold water pipe (vertical preferred), select a spot and mark it exactly with a center punch and hammer.

d. Drill a 1/4-inch hole at the marked spot, drilling through *one* side wall (vertical pipe) or the top (horizontal pipe) of the chosen pipe, as appropriate.

**Use care to avoid drilling through the *opposite* wall of the pipe.**

## NOTE

Use *only* the saddle valve supplied with the ice maker kit, or an identical valve. Do *not* use a self-piercing valve. Self-piercing valves make a hole in the pipe that is smaller than a drilled hole; water pressure is reduced and water flow to ice maker may be restricted.

e. Attach the saddle valve to the water pipe, using the parts illustrated in Figure 2.

- Thread the valve to the saddle valve clamp. The saddle valve clamp *must* be threaded onto the saddle valve stem *before* securing the saddle valve to the water pipe. The valve will *not* thread completely into the saddle valve clamp because the threads are tapered.
- Place the rubber washer between the saddle valve clamp and the water pipe.
- Tighten the two (2) bolts and two (2) nuts evenly, in increments, so spacing between both sides of the clamp remains equal.
- **Do not over-tighten.**

f. Slip the brass nut and brass sleeve onto the 1/4-inch flexible copper tubing, as shown in Figure 2.

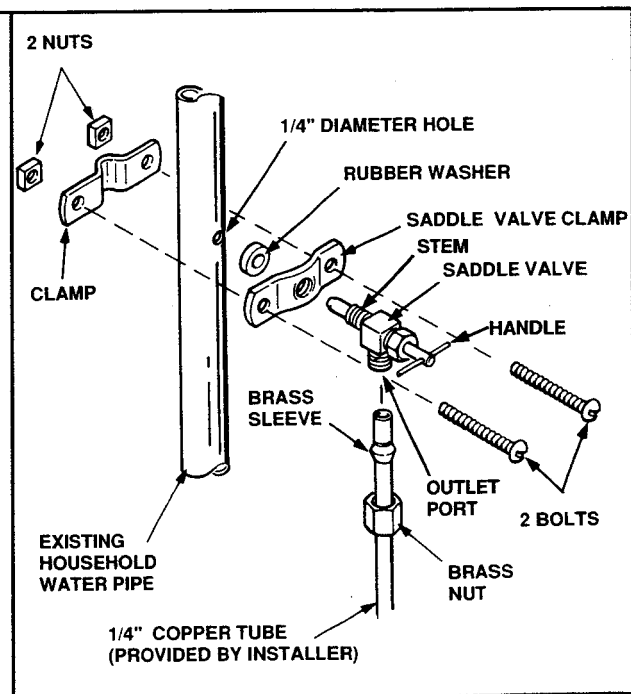

Figure 2

- g. Insert the 1/4-inch copper tube *completely* into the saddle valve outlet port. Be sure to start the nut *by hand*, turning clockwise, to avoid cross-threading. Use a 1/2-inch open-end wrench to firmly connect the brass nut on the copper tubing to the saddle valve outlet port fitting. **Tug on the tubing to check that it is secured to the coupling.**

*Do not over-tighten.*

- h. Shut off the saddle valve by rotating the handle fully clockwise. Turn on the household water supply valve.
- i. Before proceeding, be sure there are no leaks in the connections, and that the saddle valve completely shuts off the water supply.

## NOTE

Protect the floor under the wheels when moving the refrigerator.

2. Route the flexible copper tubing to the refrigerator and flush the saddle valve and tubing.
  - a. Unplug the refrigerator power cord from its electrical outlet.
  - b. Pull the refrigerator away from the wall, making sure the back is accessible.
  - c. Drill 3/8-inch holes for openings in the floor or the interior house wall behind the refrigerator, as appropriate, to allow the copper tubing to pass through easily.
  - d. Route the copper tubing to the refrigerator and put the open end into a nearby sink or pail. Open the saddle valve slightly. *Remember that the water will be under pressure.*
  - e. Allow the water to run through the copper tube for several minutes to flush the saddle valve and the tube. When flushing is completed, shut off the saddle valve.

3. Remove the lower freezer basket. Remove the solid full-width shelf with wire divider by tugging gently on the shelf and pulling it out of the freezer compartment.

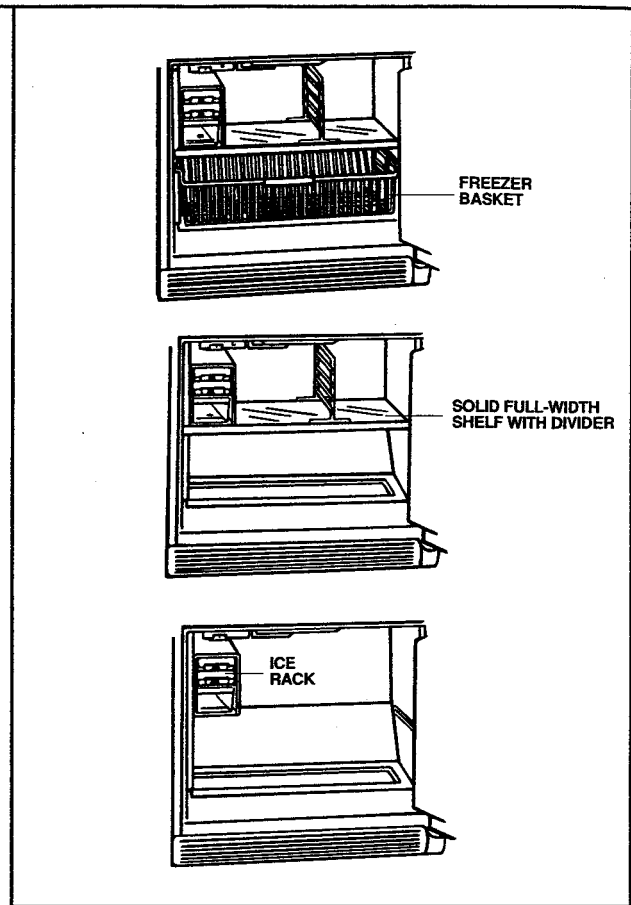

Figure 3

4. Remove ice rack from left rear wall of freezer compartment.
  - a. Remove the ice cube trays from the ice rack.
  - b. Tug gently forward on the rack to free it from the two (2) holding screws, as shown in Figure 4.
  - c. Use the 1/4-inch hex socket and driver to remove and discard the ice rack holding screws. Push two (2) white button plugs into the screw holes.

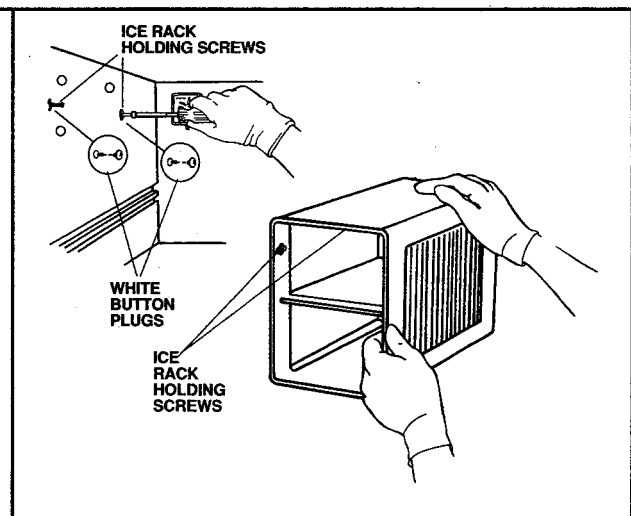
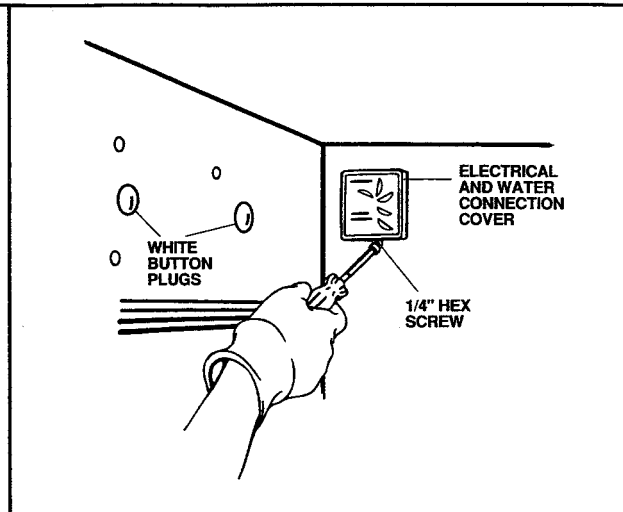
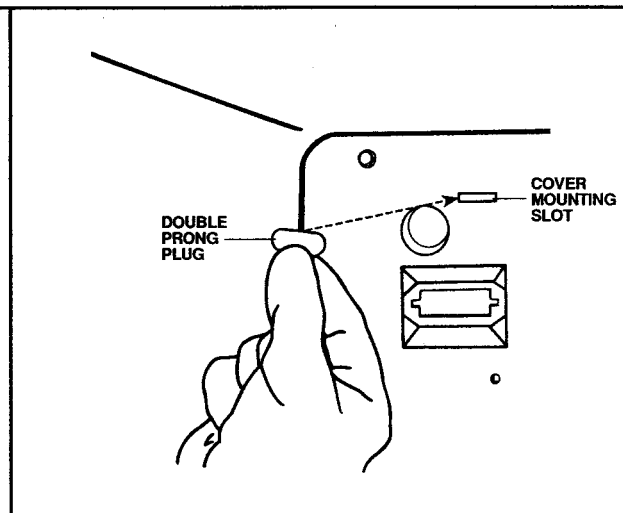

Figure 4

5. Remove the cover plate for electrical and water connection.
  - a. Use the 1/4-inch hex socket and driver to remove the screw that attaches the cover to left rear interior wall. See Figure 5.
  - b. Discard the screw and the cover.



6. Push in a double-prong plug to seal the cover mounting slot. See Figure 6.



7. Cover the flat-blade screwdriver with masking tape to protect the exterior rear surface of the refrigerator cabinet. Remove the plug for the water tube inlet hole. See Figure 7.

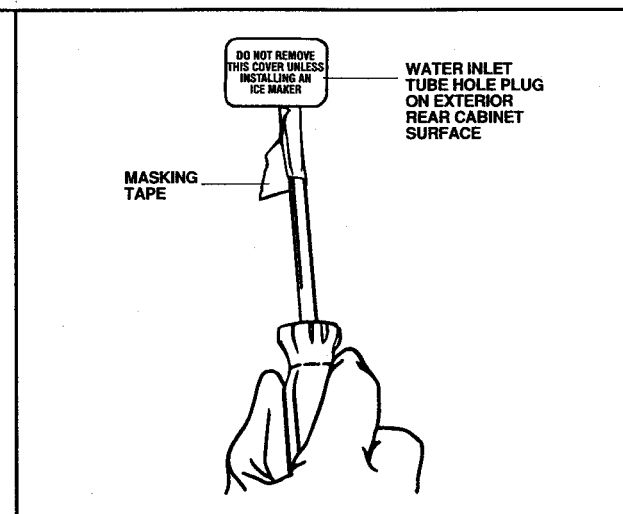

8. From the rear exterior of the refrigerator, use a flat-blade screwdriver to pierce the interior sealing tape that covers the hole for the water tube inlet. Clear a path for the water fill tube. See Figure 8.

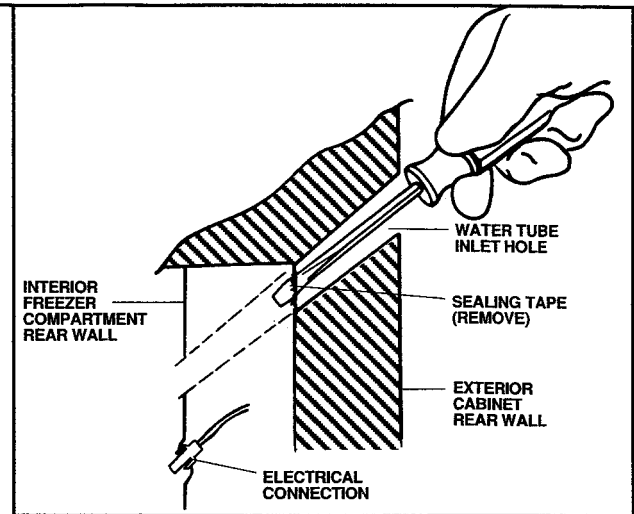

Figure 8

9. To prevent styrofoam insulation beads from entering the water fill tube during installation, temporarily cover the end of the tube with masking tape.

Install the water fill tube by pushing it through the “U”-shaped hole in the exterior rear wall of the cabinet. See Figure 9.

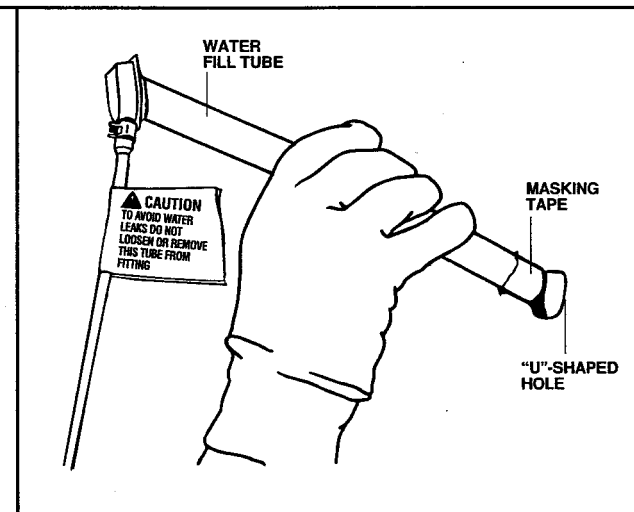

Figure 9

- a. From inside the freezer compartment, pull the water fill tube through the hole in the interior rear wall. See Figure 10.

Be sure to remove the masking tape from the end of the water fill tube to allow water to flow into the ice maker.

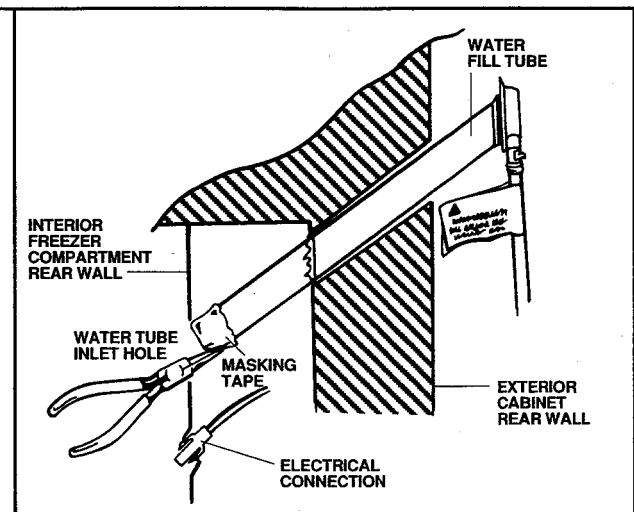

Figure 10

- b. Push gently on the water fill tube while twisting it slightly, until the flange is firmly seated inside the "U"-shaped hole on the exterior rear of the cabinet. See Figure 11.
- c. Check the exterior rear cabinet to be sure the water fill tube is completely sealed. See Figure 11.

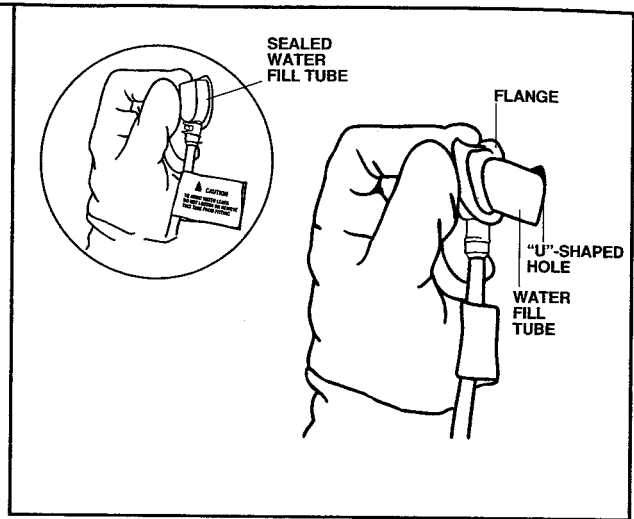

Figure 11

10. Assemble and install the ice maker.

- a. Remove the ice maker from the shipping carton and discard the packing material.
- b. Slip the stainless steel clip over the wall of the water cup. See Figures 12 and 13.

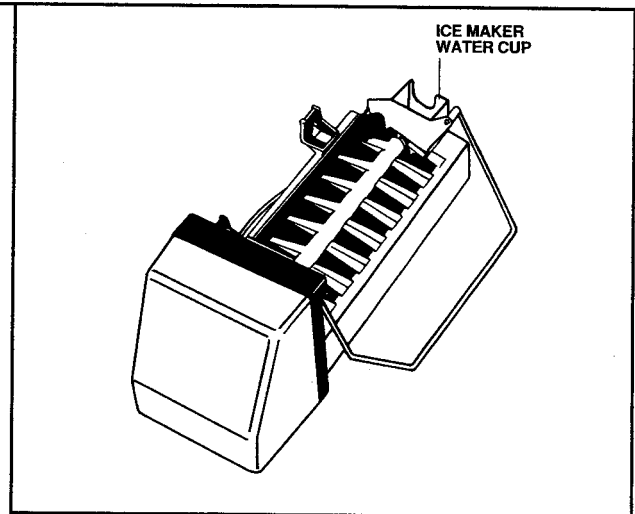

Figure 12

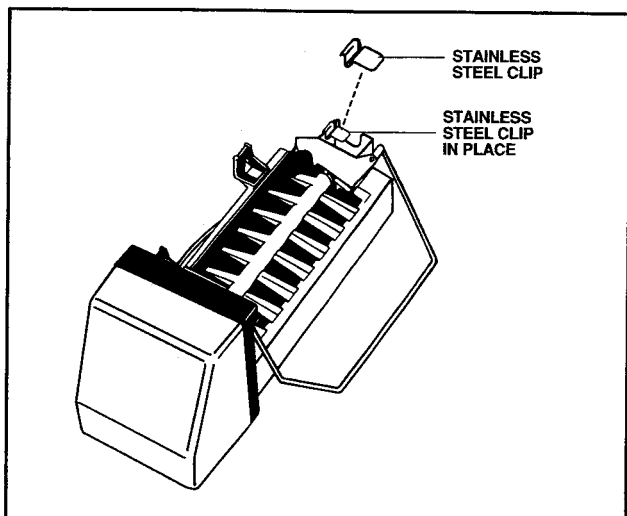

Figure 13

c. Cover the tip of a knife blade with masking tape to protect the interior surface. Carefully pry out and discard the three (3) white plastic buttons from the left side of the freezer wall. See Figure 14.

d. Start one 5/8-inch silver-colored ice maker mounting screw in the top front hole on the left interior wall of the freezer. Leave the head out approximately 3/8-inch for the slot in the ice maker hanger to slip over the screw.

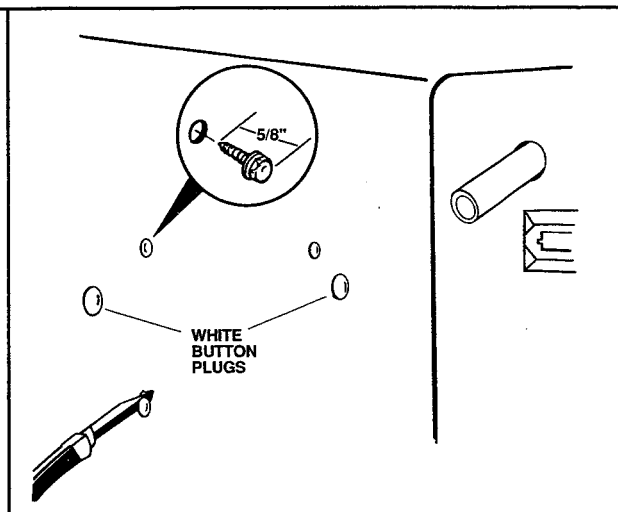

Figure 14

e. Hold the ice maker in position inside the freezer compartment. Insert the wire harness plug into the receptacle on the rear wall, using a rocking motion, until the locking fingers on sides of plug snap into place. Plug fits only one way. See Figure 15.

f. Slip the ice maker hanger over the mounting screw, while easing the ice maker water cup toward the end of the water tube that extends through the rear wall into the freezer compartment. The water tube extension fits under the stainless steel clip on the water cup. **The water tube must not be kinked. The water tube should extend approximately 1/2-inch into the water cup and must not become easily dislodged.**

g. Install the two (2) remaining 5/8-inch silver-colored ice maker mounting screws and tighten all three screws.

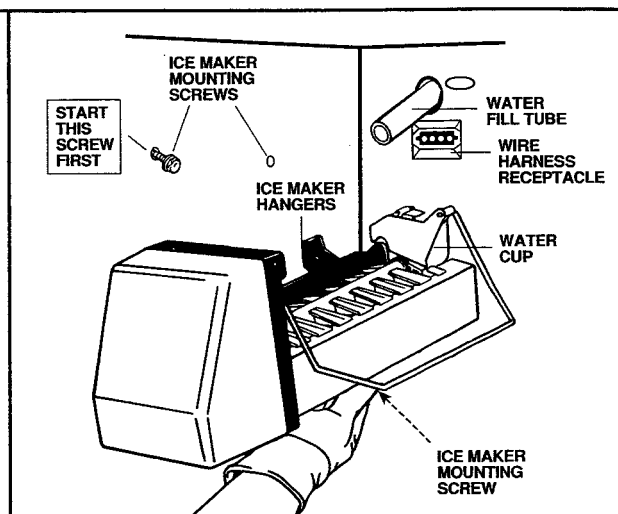

Figure 15

11. The ice maker is shipped from the factory with the shut-off arm in the *down* position, as shown in Figure 16. This is the correct position for ice making.

Do **not** force the arm up or down past the STOP positions.

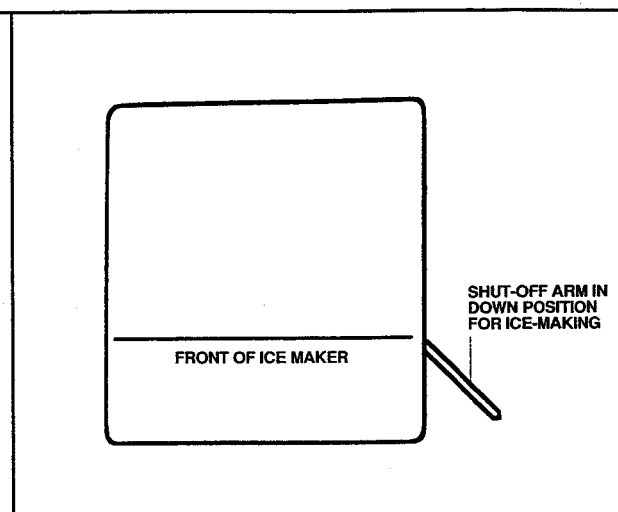

Figure 16

12. Re-install the solid full-width freezer shelf with divider and the freezer basket. The shelf **must** be installed correctly to insure proper operation of the ice maker.

13. Place the ice storage bin under the ice maker, fitting it securely against the left and rear walls of the freezer compartment. See Figure 17. Close the freezer door.

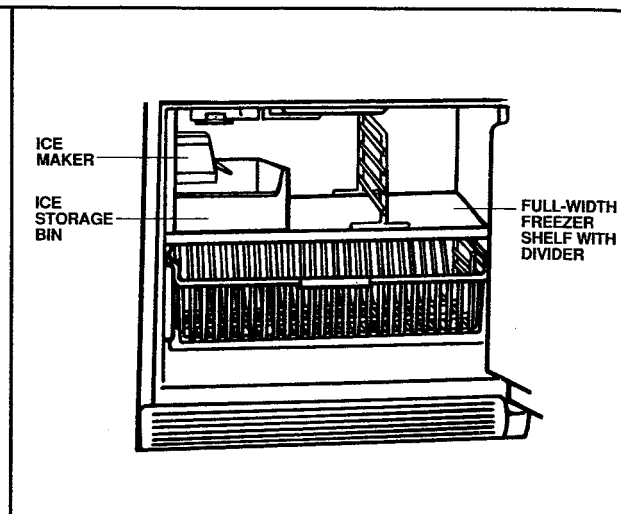

Figure 17

14. Install the water valve.

a. Remove and retain four hex screws and the vertical wire-and-tube cover from the exterior rear wall of the refrigerator. See Figure 18.

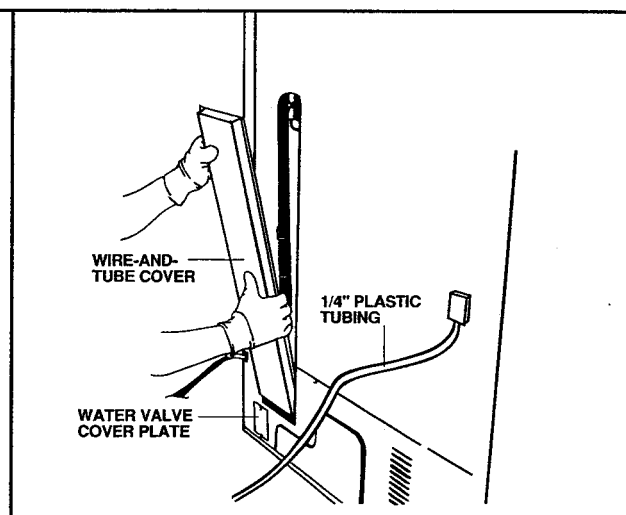

Figure 18

b. Remove and save the two (2) screws from the water valve cover plate. See Figure 19. Discard the water valve cover plate.

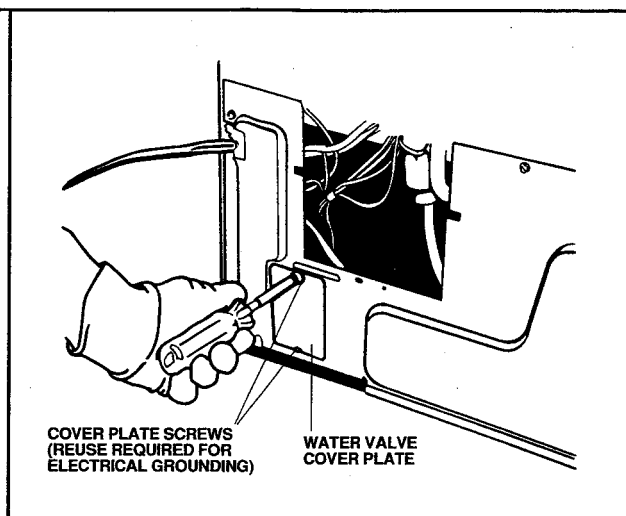

Figure 19



- c. Thread the water valve wires through the rectangular opening, as shown in Figure 20, taking care not to bend any existing tubes.

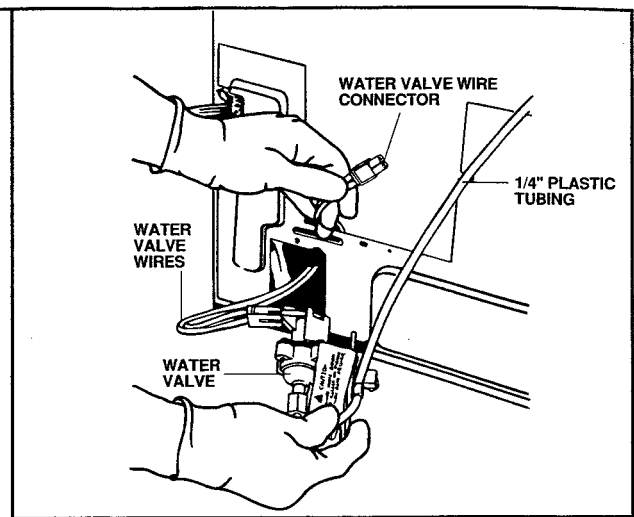

Figure 20

- d. To insure the water valve is electrically grounded, reuse of the two (2) screws saved when removing the water valve cover plate is **required**. Secure the water valve to the cabinet frame by reusing the cover plate screws. See Figure 21.

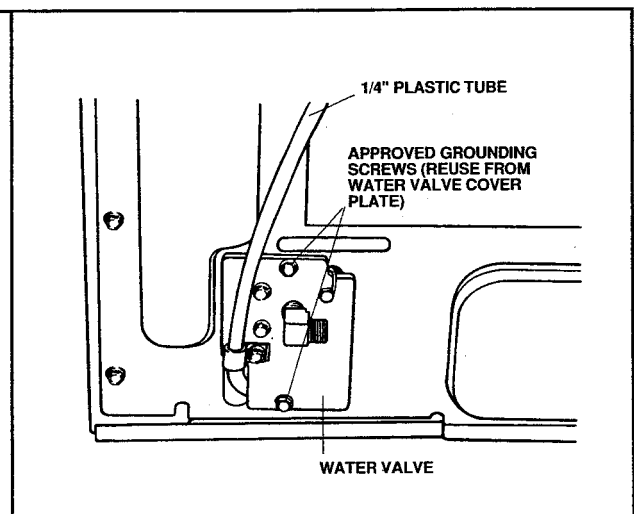

Figure 21

- e. Plug the water valve wire connector into the terminal board at the points on the bottom right position, marked "1" and "2," across from "A" and "B." See Figure 22.

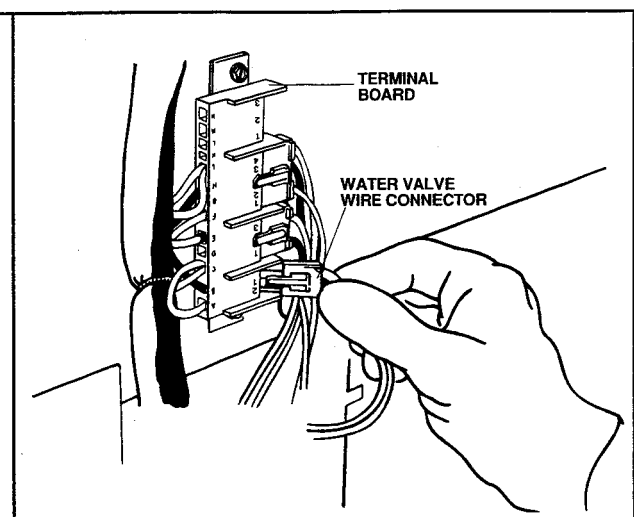

Figure 22

- f. Remove yellow plastic cap on water valve before connecting the 1/4-inch flexible copper tubing (provided by installer) to the water valve with a 1/4-inch tube compression nut and sleeve. See Figure 23.

Insert the 1/4-inch copper tube completely into the water valve outlet port. Be sure to start the nut *by hand*, turning clockwise, to avoid cross-threading. Use 1/2-inch and 3/8-inch open-end wrenches to firmly connect the brass nut on the copper tubing to the water valve outlet port fitting. **Tug on the tubing to check that it is secured to the coupling.**

**Do not over-tighten.**

- g. Open the saddle valve on household water supply one turn counter-clockwise to check for water leaks. Turn off the saddle valve before correcting any leaks. Repeat this process until no leaks are found; then, completely open the saddle valve.

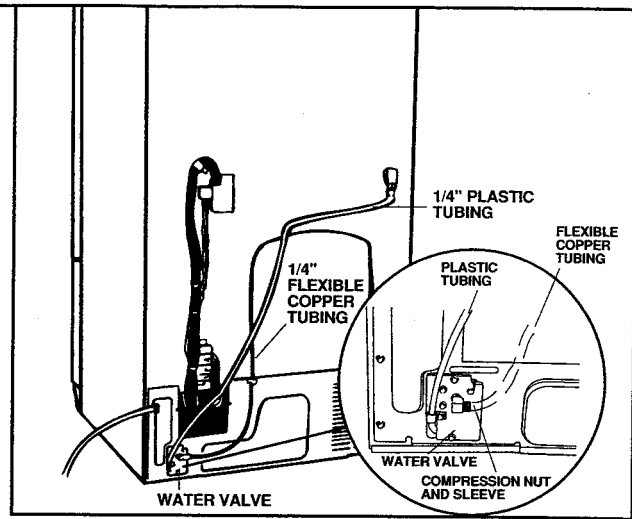

Figure 23

- h. Re-install the vertical wire-and-tube cover on exterior rear surface of the cabinet. To avoid pinching wires, carefully tuck the wires inside the cover. Secure the cover by reusing *all* original screws. See Figure 24.

i. **IMPORTANT**

Secure the 1/4-inch flexible copper tubing with the "P" clamp at the back horizontal cover, using the existing cover screw. See Figure 24.

- j. Secure the 1/4-inch flexible plastic tubing to the rear wall of the refrigerator cabinet using the plastic stick-on clamp. See Figure 24.

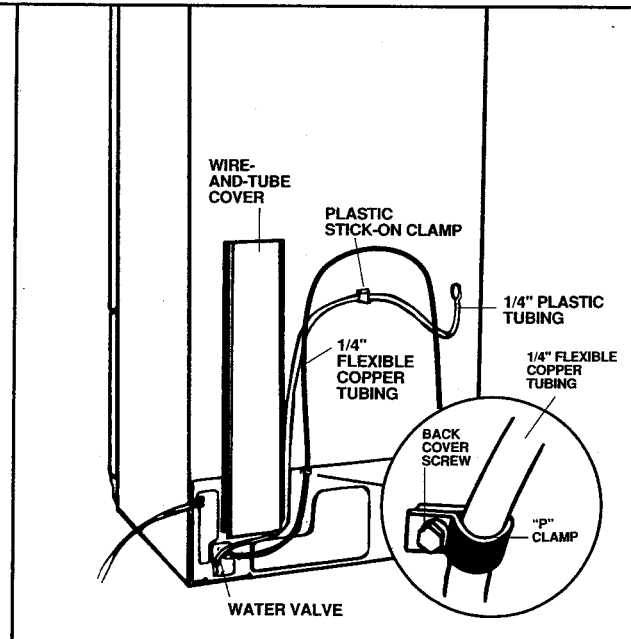

Figure 24



**CAUTION**

All covers *must* be in place for proper operation and safety.

15. Plug the electrical power cord into the wall receptacle.
16. Return the refrigerator to its normal operating location. Turn the freezer control on and set it at the middle position.

# Ice Maker Operation

1. The ice storage bin must be in place; the ice maker shut-off arm must be in the *down* position; the saddle valve must be completely open (turned counter-clockwise).
2. Once the freezer reaches normal temperature, the ice maker will fill with water and ice cubes will be produced.
3. After ice cubes are formed, they are lifted out of the icemaker and dropped into the ice storage bin. Ice-making continues until the storage bin is filled. During each ice-making cycle, the shut-off arm raises and lowers. When the ice bin is full, the shut-off arm senses the accumulation of ice and automatically turns the ice maker off.

## NOTE

The first *three* harvests of ice should be discarded, since they may contain contaminants from the ice maker or from the water system.

4. To stop ice maker operation at any time, gently raise the shut-off arm to the OFF position. See Figure 25. *Do not force the arm up.*



### CAUTION

To avoid damage to the ice maker, do *not* raise the shut-off arm past the maximum position. See Figure 25.

5. As the ice maker operates, the normal sounds of the motor, water running into the ice cube molds, ice cube ejector, and ice cubes dropping into the ice storage bin will be heard.



### CAUTION

Before leaving on vacation or for extended periods of time, turn off the water supply to the ice maker at the saddle valve, and raise the ice maker shut-off arm to the upper position. Failure to take these precautions may result in property damage.

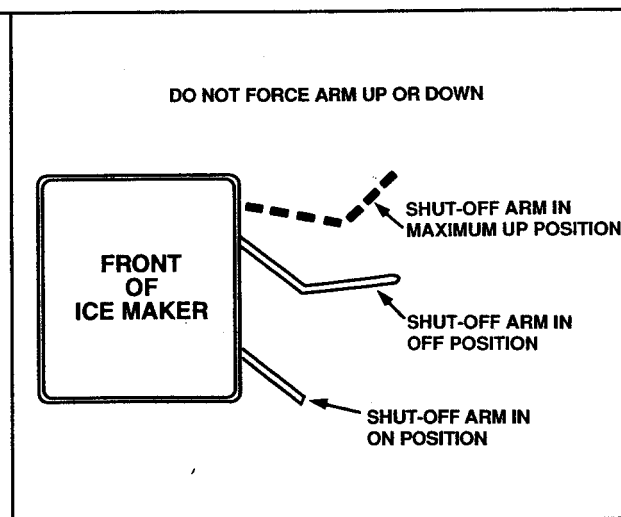

Figure 25

# Ice Maker Service Checks

---

If the preceding installation instructions are followed carefully, there is little chance that the ice maker will fail to function properly. In general, give the ice maker one (1) overnight period before assuming that a problem exists. In the event the ice maker does not operate properly, the following checks should be made by you, the owner, before contacting an authorized Amana Servicerc.

## NOTE

The ice maker is designed to produce up to five (5) pounds of ice in a 24-hour period during normal operation.



## WARNING

To avoid the risk of electrical shock, which can cause severe personal injury or death, **DISCONNECT THE REFRIGERATOR FROM ITS POWER SOURCE** before attempting disassembly.

## CHECKPOINTS

1. The saddle valve installed in the household water supply system and water pipe must be fully open (handle completely counter-clockwise).
2. The ice maker wiring harness plugs must be fully seated into the proper holes in the receptacle at the rear of the interior freezer compartment.
3. The flexible copper tubing and the plastic water tube must be free of kinks which could block the flow of water to the ice maker. Remove the kinks or replace the kinked tube(s), as appropriate.
4. The plugs for the electrical connections to the water valve coil and terminal must be tightly seated into all terminals. Remove the vertical rear wire-and-tube cover from the refrigerator to check the connections. See Figures 18 and 22. *Replace the vertical rear wire-and-tube cover before returning the refrigerator to normal use. The refrigerator will not operate properly with any cover removed.*