

use & care guide

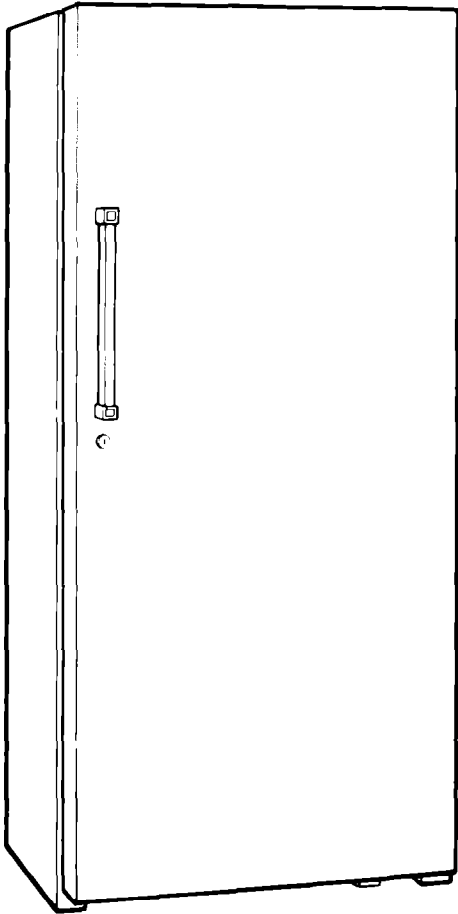

Whirlpool

Estate SERIES

**UPRIGHT
FREEZER**

Model EV190E

Freezers, Refrigerator-Freezers, Ice Makers, Dishwashers, Built-In Ovens and Surface Units, Ranges, Microwave Ovens, Trash Compactors, Room Air Conditioners, Dehumidifiers

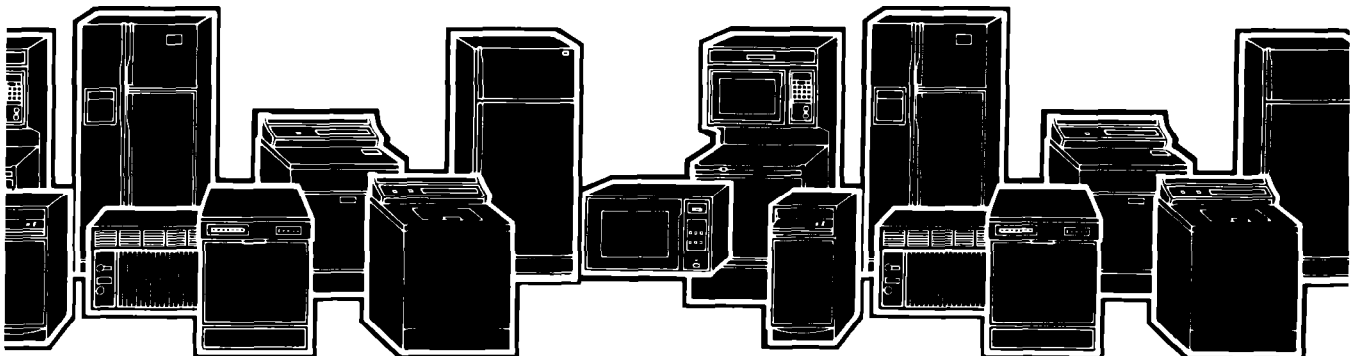

Please read this Use and Care Guide before you do anything else...

This booklet tells you how to start your freezer, defrost it, clean it and adjust controls.

Treat your new freezer with care. Use it only to do what home freezers are designed to do.

Parts and features

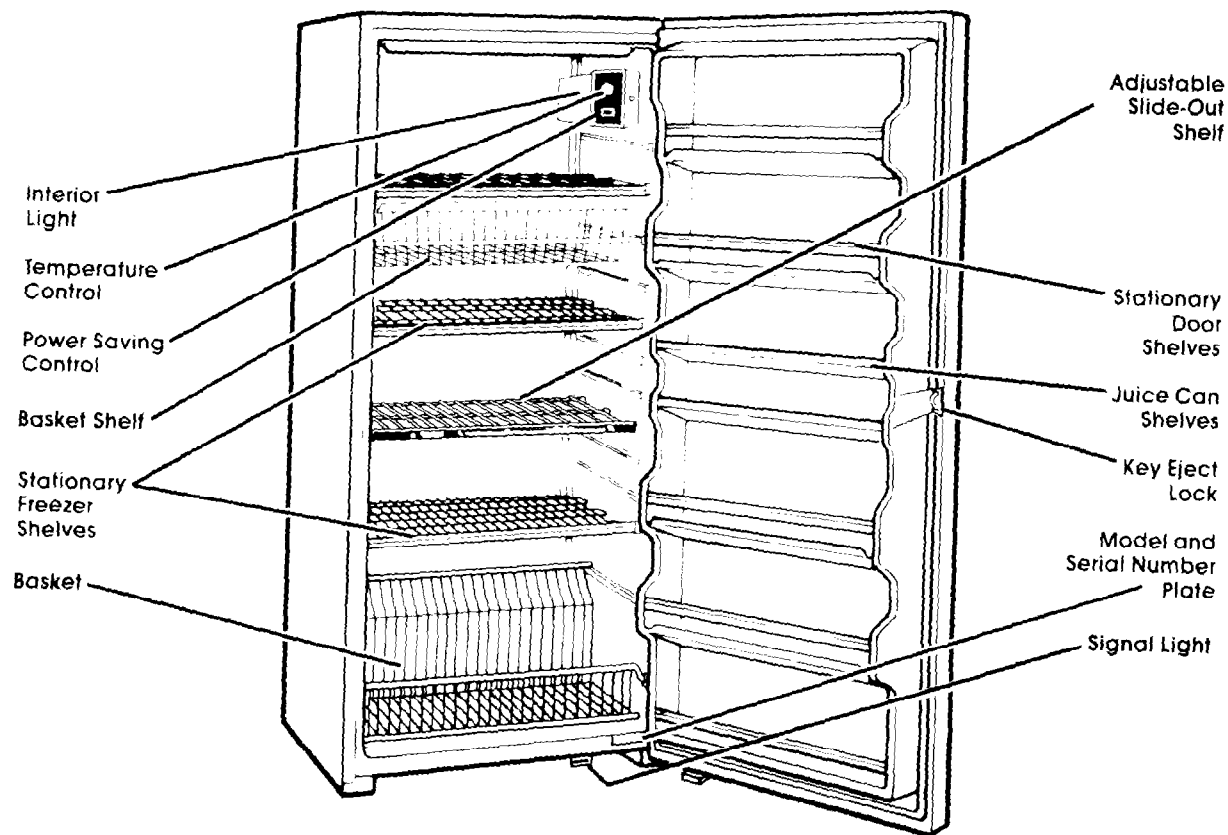

Copy your Model and Serial Numbers here...

When you need service, or call with a question, have this information ready.

1. Complete Model and Serial Numbers (from the plate located as shown).

2. Purchase date from sales slip.

Copy this information in these spaces. Keep this book, your warranty and sales slip together in a handy place. There is no warranty registration to return. Proof-of purchase is all that is required for in-warranty service.

Model Number _____

Serial Number _____

Purchase Date _____

Service Company and Telephone Number _____

Contents

	Page		Page
SAFETY FIRST	3	The Signal Light	6
BEFORE YOU PLUG IT IN	3	Energy Saving Tips	6
Install Properly	4	CLEANING YOUR FREEZER	7
Level Freezer	4	Cleaning Chart	7
Remove Sales Labels	4	FREEZING FOOD IN YOUR FREEZER	8
Clean It	4	Packaging and Sealing Food	8
Plug It In	4	To Wrap Foods	8
USING YOUR FREEZER	5	Loading	9
Setting the Temperature Control	5	Storing Frozen Food	9
Adjusting the Temperature Control	5	VACATION AND MOVING CARE	10
Cooling Freezer First	5	Vacations	10
The Power Saving Control	5	Shutting Off and Moving	10
Changing the Light Bulb	5	IF YOU NEED SERVICE OR ASSISTANCE	11
Adjusting the Basket Shelf	5	1. Before Calling for Assistance	11
Removing the Bottom Basket	6	2. If You Need Assistance	11
Adjusting the Freezer Shelf	6	3. If You Need Service	11
The Key Eject Lock	6	4. If You Have a Problem	11

© 1985 Whirlpool Corporation

Safety first

Child entrapment and suffocation are not things of the past. Junked or abandoned freezers are still dangerous...even if they will "just sit in the garage a few days."

If you are getting rid of your old freezer, do it safely. Please read the enclosed safety booklet from the Association of Home Appliance Manufacturers. Help prevent accidents.

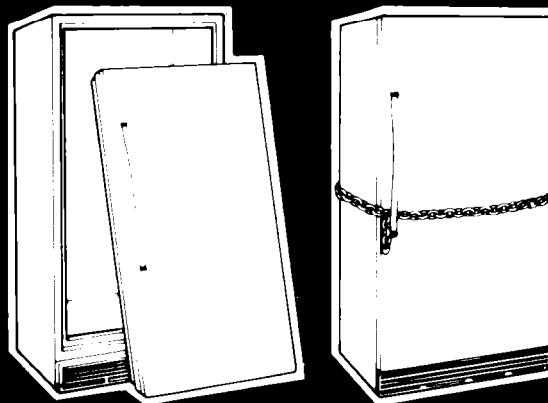

Before you plug it in

IMPORTANT

Before using your freezer, you are personally responsible for making sure that it...

- is installed and levelled on a floor that will hold the weight, and in an area suitable for its size and use
- is connected only to the right kind of outlet, with the right electrical supply and grounding. (Refer to your "Electrical Requirements and Grounding Instructions.")
- is used only for jobs expected of home freezers.
- is not near an oven, radiator or other heat source.
- is properly maintained.
- is out of the weather.
- is used in an area where the room temperature will not exceed 110° F (43.3°C).
- is not run where there are explosive fumes.
- is not used by those who may not understand how it should be used.
- is not loaded with food before it has time to get properly cold.

Install properly...

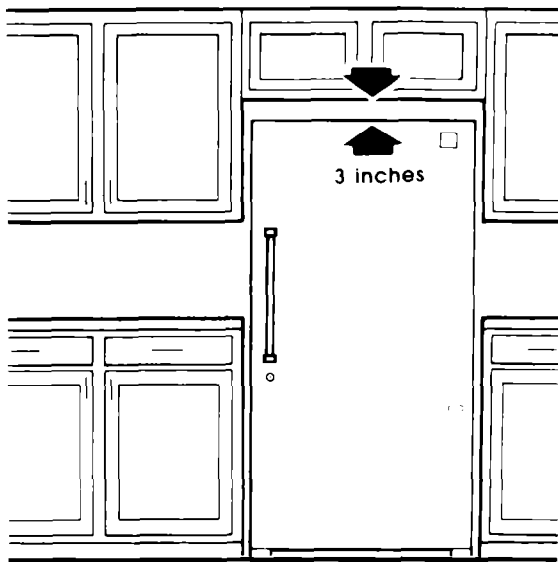

1. Check the strength of the floor. It should hold the weight of a fully loaded freezer.
2. **Pick a safe place, indoors, away from inflammables such as gasoline.**
3. Allow 3 inches (7.5 cm) air space on top of freezer for proper ventilation.
4. Allow at least an inch (2.5 cm) between the freezer condenser, on the back of the unit, and the wall.
5. Allow 1/2 inch (1.25 cm) on each side of the freezer for ease of installation.
6. If the freezer is to be against a wall, you might want to leave extra space on the hinge side so the door can be opened wider.

Level freezer...

so the door will stay open at any position.

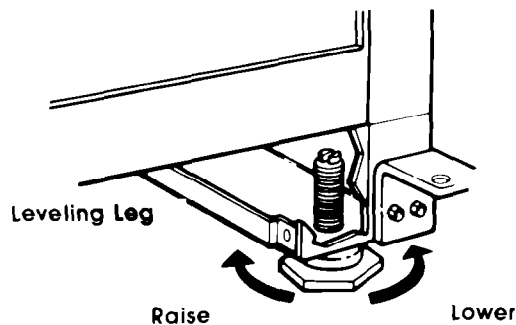

This freezer has 2 threaded leveling legs that are shipped in a separate package.

1. Screw these legs all the way into bolt holes in the bottom front corners of the freezer.
2. Slide the freezer into place.
3. Adjust front legs to level the freezer.
 - To raise front, turn legs clockwise.
 - To lower front, turn legs counterclockwise.
4. Check with level.
5. After freezer is fully loaded, recheck with level.

Remove sales labels...

Remove the Consumer Buy Guide label and any **inside** labels before using the freezer.

To remove any remaining glue:

1. Rub briskly with thumb to make a ball, then remove.

OR

2. Soak area with dishwashing detergent solution (1 teaspoon detergent in 1 quart warm water) before removing glue as described in step 1.

DO NOT USE rubbing alcohol or flammable or toxic solvents, such as acetone, gasoline, carbon tetrachloride, etc. These can damage the material.

NOTE: DO NOT REMOVE the Tech Sheet fastened under the freezer at the front.

Clean it...

Clean your freezer before using it. See cleaning instructions on page 7.



Plug it in...

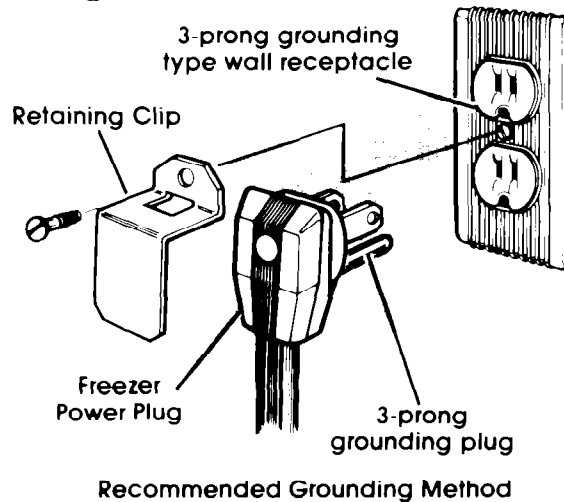

A 115 Volt, 60 Hz., AC only 15 or 20 ampere fused and properly grounded electrical supply is required. It is recommended that a separate circuit serving only this appliance be provided. **Use a receptacle which cannot be turned off with a switch or pull chain. Do not use an extension cord.**

Attach retaining clip over power cord plug from literature package inside the freezer.

Using your freezer

Setting the temperature control...

To start, turn control to the middle of the dial. This setting is designed to maintain the temperature at or near 0 F (-17.8 C) under normal operating conditions.

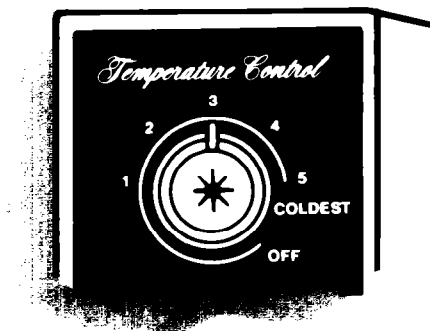

The Power Saving Control...

operates electric heaters. These heaters help prevent moisture from forming on the outside of the freezer when humidity is high.

1. Use the OFF setting when humidity is low.
2. Use the ON setting only if moisture forms on the outside of the freezer.

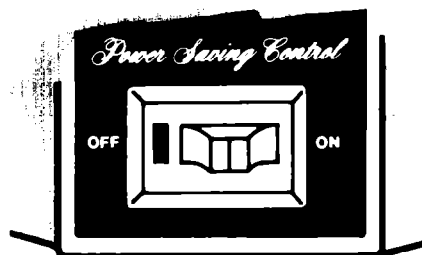

Changing the light bulb...

Light Shield

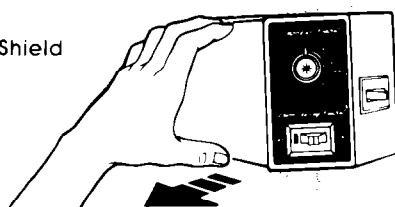

Adjusting the temperature control...

1. Turn control to higher number for colder temperatures.
2. Turn to lower number for less cold temperatures.

Cooling freezer first...

1. Allow freezer to cool 6 to 8 hours before filling with **frozen food**.
2. Let it cool overnight before adding large amount of **unfrozen food**.

Note: When freezer is first started, the compressor will run constantly until the cabinet is cooled. It may take up to 6 to 8 hours or longer, depending on room temperature and the number of times the freezer door is opened.

After the cabinet is cooled, the compressor will turn ON and OFF as needed to keep the freezer at the proper temperature.

WARNING: To avoid possible shocks, first unplug freezer or turn off electricity leading to freezer at the main power supply.

1. Remove the light shield from the side of the control panel. Depress the back of the shield to release the tabs, then pull away.
2. Replace bulb with a 40-watt appliance bulb.
3. Replace the light shield. Insert the shield tabs in the slots, then press the shield to snap into place.

Adjusting the basket shelf...

To remove basket shelf:

1. Remove food from basket.
2. Slide basket straight out to stop.
3. Lift front.
4. Slide the rest of the way out.

To replace basket shelf:

1. Fit back of basket shelf on top of guide stops on bottom of guides.
2. Lift front, then slide the basket until it clears the guide stops.

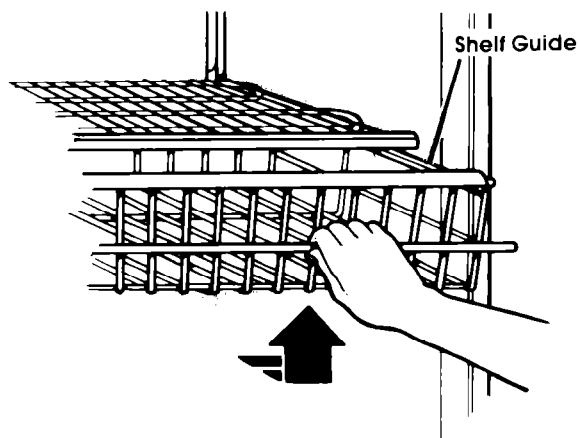

Removing the bottom basket ...

To remove:

1. Lift front of basket up to remove from wall supports.
2. Pull out.

To replace:

1. Position basket in bottom of freezer.
2. Insert basket into wall supports one side at a time.

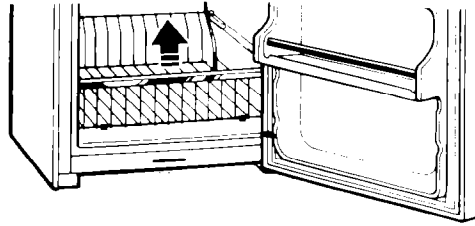

Adjusting the freezer shelf...

To remove shelf:

1. Remove food from shelf.
2. Slide shelf straight out to stop.
3. Lift front.
4. Slide the rest of the way out.

To replace shelf:

1. Fit back of shelf on top of guides with wire stops on bottom of guides.
2. Lift front, then slide shelf until it clears the guide stops.

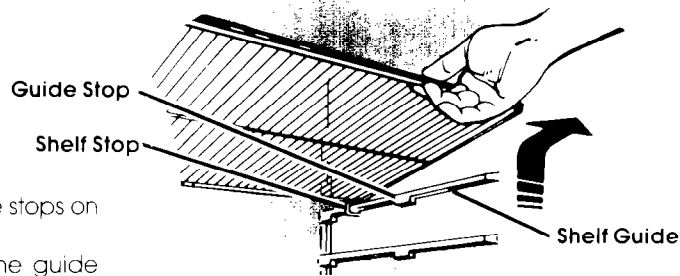

The key eject lock...

can help reduce the hazard of child entrapment

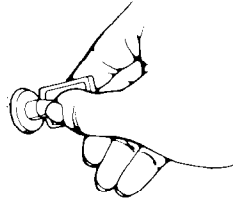

To lock or unlock the freezer you must hold the key in the lock while turning. The lock is spring loaded so the key cannot be left in the lock.

If the key is lost, contact your WHIRLPOOL dealer for a replacement. Always give the **complete** model and serial number of your freezer when requesting a replacement key.

The signal light...

automatically warns of any unexpected power failure.

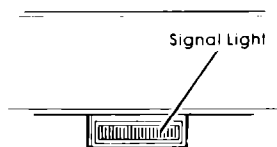

If the signal light is not glowing, immediately check:

- for power interruption,
- for an unplugged power cord,
- for a burned out signal light.

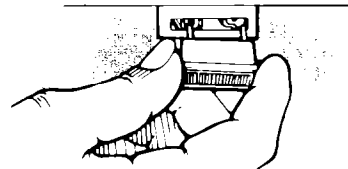

To replace burned out signal light:

1. Unplug power cord from outlet.
2. Open the freezer door.
3. Push out signal light from behind, then unplug burned out light. Replace light with one of the same wattage and size. Signal light can be ordered from your WHIRLPOOL dealer, Part No. 1103639.
4. Close freezer door and plug power cord into outlet.

Energy saving tips...

You can help your freezer use less electricity.

- Check door gasket and level freezer to assure a good door seal.
- Clean the condenser coils regularly.
- Keep door openings to a minimum. Remove several items at one time. Keep contents organized to eliminate searching.
- Fill to capacity. Follow recommended procedures for freezing foods. See pages 8 and 9.

- Set Temperature Control to provide temperatures around 0 F (-17.8 °C). There is no need to store foods below 0 F.
- Keep door locked to ensure door closure.
- Do not let frost build up to more than ¼ inch (6 mm) thick. Efficiency is reduced.
- Keep Power Saving Control on OFF when humidity is low.

Cleaning your freezer

This freezer should be cleaned when frost has built up to about ¼ inch (6 mm) thickness. Complete defrosting and cleaning should be done at least once a year. In high humidity areas, a freezer may need more frequent defrosting.

To defrost and clean:

1. Turn Temperature Control to OFF.
2. Unplug power cord.
3. Place a shallow pan (sides no higher than 1 inch) on floor under drain hole in bottom of freezer.

CAUTION: Do not place pan under the right hand side of the freezer. Coils under the freezer could be damaged and sharp edges of the freezer could cause personal injury.

4. Take out all food and removable parts.

Note: Wrap frozen foods and packages in several layers of newspaper and cover with blanket. Food will stay frozen for several hours.

5. Place pan of hot water inside freezer to speed melting of frost. Keep door open. Ice can be removed in large pieces as it melts. Direct air from electric fan into freezer to speed defrosting.
6. Clean freezer according to the following directions.

After defrosting:

1. Remove shallow pan from underneath freezer.
2. Plug in power cord.
3. See directions for "Setting the Temperature Control;" page 5.

Cleaning chart...

Part	What to use	How to clean
Removable parts (baskets, shelf)	Sponge or cloth; mild detergent and warm water.	<ul style="list-style-type: none"> • Wash with warm water and a mild detergent • Rinse and dry
Outside	Sponge, cloth or paper towel; mild detergent, appliance wax (or good auto paste wax)	<ul style="list-style-type: none"> • Wash with warm water and a mild detergent. Do not use abrasive or harsh cleansers. • Rinse and dry. • Wax painted metal surfaces at least twice a year with appliance wax or a good auto paste wax. Apply wax with a clean, soft cloth. Do not use wax on plastic parts. <p style="text-align: center;">Waxing painted metal surfaces provides rust protection.</p>
Inside walls	Plastic scraper pans of hot water, electric fan; sponge or towel, baking soda and warm water	<ul style="list-style-type: none"> • Use plastic scraper to remove frost • Place pans of hot water in freezer with door open to speed melting. Directing air from an electric fan into freezer will also help. • Wash with solution of 2 tablespoons (26 g) baking soda to 1 quart (.95 L) warm water. • Rinse and dry <p style="text-align: center;">DO NOT USE an ice pick, knife or other sharp-pointed tool or any type of electric defroster to defrost freezer. They can cause damage to the liner and interior parts.</p>
Door liner and gasket	Sponge, soft cloth or paper towel, mild detergent and warm water	<ul style="list-style-type: none"> • Wash with mild detergent and warm water. • Rinse and dry <p style="text-align: center;">DO NOT USE cleaning waxes, concentrated detergents, bleaches or cleansers containing petroleum on plastic parts.</p>
Condenser coils	Use vacuum cleaner with brush attachment. WARNING: Watch out for sharp wire ends at top of condenser coils. They can cause injury or damage brush.	<ul style="list-style-type: none"> • Slide freezer out away from the wall. • Clean dust and lint from condenser coils behind the freezer, every two or 3 months.

Freezing food in your freezer



When freezer has cooled to a safe storage temperature, it may be loaded with **frozen food**.

When you plan to freeze **unfrozen food**, see the following chart for the amount to freeze at **one time**.

POUNDS OF FOOD TO FREEZE AT ONE TIME*		
Size of Freezer	Meat or Fish	Vegetables or Fruit
19.1 cu. ft. (545.5 L)	38.2 lbs. (17.2 kg.)	57.3 lbs. (25.8 kg.)

*These amounts are based on USDA recommendations. If too many packages of unfrozen food are packed at one time into the freezer, the rate of freezing is too slow. Poor quality products result.

Packaging and sealing food...

Airtight packaging is important in freezing foods. Containers and wrappings should be moisture and vapor-proof and packages should be sealed carefully to keep moisture in and air out.

Freezer burn can result if food is not properly wrapped. When this happens, food dehydrates and is of poor quality.

To wrap foods...



1. Cut sheet of wrapping material about one-third longer than distance around food to be wrapped. Place wrapping sheet on flat surface with food in center of sheet.

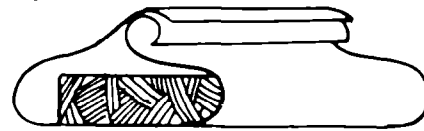

2. Bring front and back of wrapping together and fold in toward food, making at least two one-inch (2.5 cm) folds until food fits tightly against wrapping.

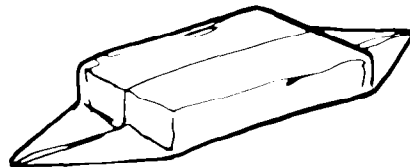

3. Crease ends close to food to eliminate air pockets.

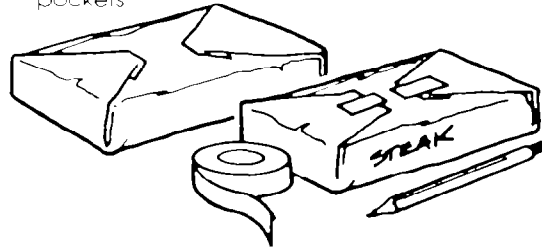

4. Press all air from package. Fold each end over twice. Make sure fold is tight and fasten against end of package with freezer tape.

NOTE: When packaging meats that have not been boned, pad sharp edges with extra wrap or use stockinette to protect against tearing or puncturing.

Use heavy-duty aluminum freezer foil, kraft paper with cellophane bonded to it, special freezer bags, jars, cartons and freezer sealing tape for packaging your food items. You'll find them at the supermarket or freezer dealer.

See booklet, "How to Preserve Foods the Modern Way with Your WHIRLPOOL Freezer," for complete information and tips on home freezing.

Loading...

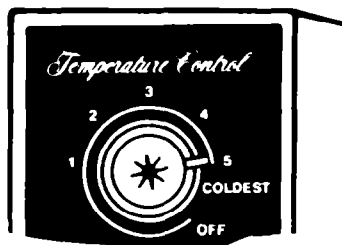

1. Before freezing large quantities of food, turn Temperature Control to highest setting and let freezer operate for several hours. **After loading all food items, return Temperature Control to the usual setting.**

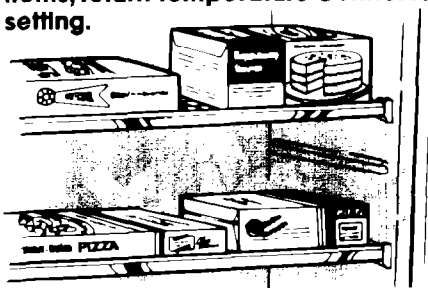

2. To speed freezing, lay packages in a single layer so each rests on the freezing surface of a shelf. Leave space between packages.
3. Add more unfrozen food after first load is frozen (approximately 18 to 24 hours)

Storing frozen food...

After food is frozen, stack packages anywhere in the freezer. Packages should not extend beyond the shelf edge or they may keep the door from closing and sealing properly.

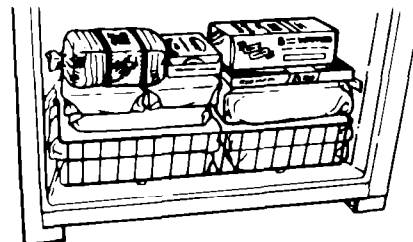

Baskets – Store heavy and bulky packages here. Baskets should be in place at all times for proper air circulation.

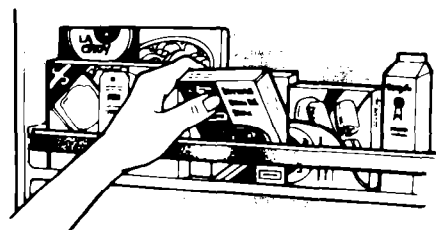

Door storage – Store packages on the door shelves behind the retaining bar.

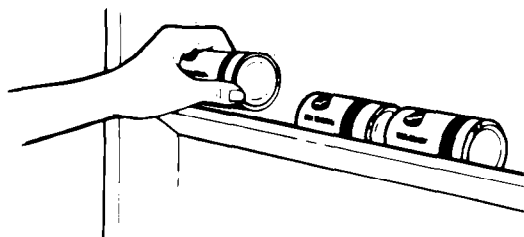

Juice can shelves – Store juice cans on door as shown.

Vacation and moving care

Vacations...

Arrange for someone to make regular checks of your freezer to make sure it is operating and electricity has not been interrupted.

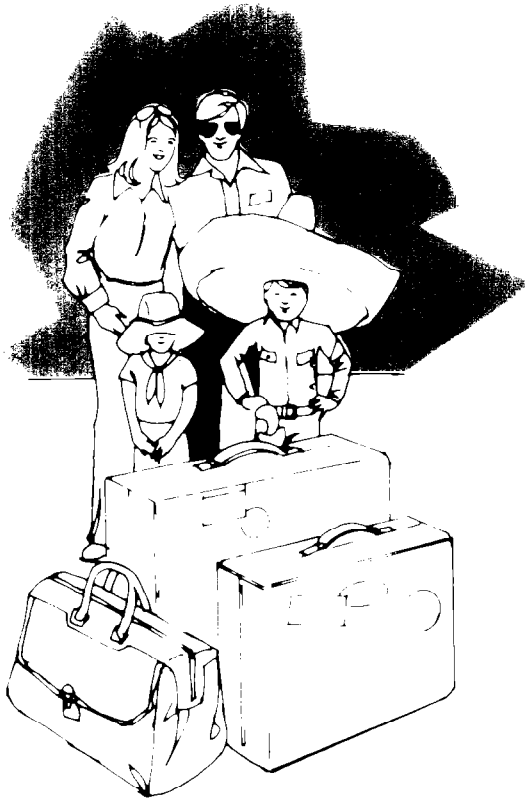

Shutting off and moving...

If freezer is shut off for more than 24 hours:

1. Remove and store all food.
2. Unplug freezer.
3. Clean thoroughly. See "Cleaning your freezer," page 7.
4. Block door open for air circulation. Turn lock to locked position with door open. Place blocks between door and cabinet and tape in place with self-adhesive filament tape.

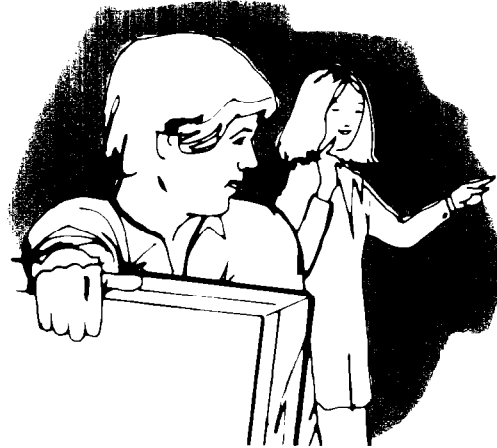

If you move the freezer:

1. Remove the baskets.
2. Do not place objects inside cabinet.
3. Level properly to ensure good door seal.

WARNING:

Do not allow children near the freezer when the door is blocked open. They may become injured or trapped.

To restart freezer, see "Using your freezer," page 5.

If you need service or assistance, we suggest you follow these four steps:

1. Before calling for assistance...

Performance problems often result from little things you can find and fix yourself without tools of any kind.

If electricity goes off:

Learn how long power will be off by calling the power company.

- If service is to be interrupted 24 hours or less, keep freezer closed. Most food will stay frozen.
- If service is to be interrupted longer than 24 hours, do this:
 1. Remove all unfrozen food and store in a frozen food locker. **OR...**
 2. Place 2 lbs. (0.9 kg) of dry ice in freezer for every cu. ft. of freezer space. This will keep frozen foods for 2 to 4 days. Wear gloves to protect your hands from dry ice burns.
 3. If neither food locker storage or dry ice is available, use or discard perishable food at once.
- The length of time food will stay frozen depends on several factors. For instance, a full freezer will remain cold longer than a freezer partially filled. And a freezer full of meat will stay cold longer than a freezer filled with baked goods. Also, if the food still contains ice crystals, it may be safely refrozen, although the quality and flavor may be affected. Use this food as soon as convenient. If the condition of the food is poor or is in any way questionable, it is wise to dispose of it.

If freezer stops running:

- Check to see if power cord is plugged into the outlet.
- Check fuse box or circuit breaker.
- Check electric company for a power failure.
- Be sure Temperature Control is turned ON.

If compressor seems to run too long:

- Check to see that condenser, located on back of freezer, is free of dust and lint.
- On hot summer days or if room is hot, compressor will run longer to provide the correct amount of cooling.
- If large amounts of unfrozen food have been put into the freezer, compressor will run longer.
- Check to see that there is enough air circulation space above and in back of the freezer.



FSP is a registered trademark of Whirlpool Corporation for quality parts. Look for this symbol of quality whenever you need a replacement part for your Whirlpool appliance. FSP replacement parts

will fit right and work right, because they are made to the same exacting specifications used to build every new Whirlpool appliance.

2. If you need assistance*...

Call Whirlpool COOL-LINE® service assistance telephone number. Dial free from:

- Continental U.S. (800) 253-1301
- Michigan (800) 632-2243
- Alaska & Hawaii (800) 253-1121

and talk with one of our trained Consultants. The Consultant can instruct you in how to obtain satisfactory operation from your appliance or, if service is necessary, recommend a qualified service company in your area.

3. If you need service*...



Whirlpool has a nationwide network of franchised TECH-CARE® Service Companies. TECH-CARE service technicians are trained to fulfill the product warranty and provide after-warranty service, anywhere in the United States. To locate

TECH-CARE service in your area, call our COOL-LINE service assistance telephone number (see Step 2) or look in your telephone directory Yellow Pages under:

- | | | |
|--|----|--|
| APPLIANCES - HOUSEHOLD -
MAJOR - SERVICE & REPAIR | OR | ELECTRICAL APPLIANCES -
MAJOR - REPAIRING & PARTS |
| WHIRLPOOL APPLIANCES
FRANCHISED TECH-CARE SERVICE | | WHIRLPOOL APPLIANCES
FRANCHISED TECH-CARE SERVICE |
| SERVICE COMPANIES | | |
| XYZ SERVICE CO
123 Maple 999-9999 | | XYZ SERVICE CO
123 Maple 999-9999 |
| OR | | |
| WASHING MACHINES, DRYERS
& IRONERS - SERVICING | | |
| WHIRLPOOL APPLIANCES
FRANCHISED TECH-CARE SERVICE | | |
| SERVICE COMPANIES | | |
| XYZ SERVICE CO
123 Maple 999-9999 | | |

4. If you have a problem*...

Call our COOL-LINE service assistance telephone number (see Step 2) and talk with one of our Consultants, or if you prefer, write to:

Mr. Stephen E. Upton
Senior Vice President
Whirlpool Corporation
Administrative Center
2000 US-33 North
Benton Harbor, MI 49022

*If you must call or write, please provide: model number, serial number, date of purchase, and a complete description of the problem. This information is needed in order to better respond to your request for assistance.



Making your world a little easier.

Part No. 1104075
©1985 Whirlpool Corporation

Printed in U.S.A.

Makers. Dishwashers. Built-In Ovens and Surface Units, Ranges, Microwave Ovens, Trash Compactors, Room Air Conditioners, Dehumidifiers, Automatic Washers, Clothes Dryers.

