

Vertical Freezer

Use and Care Guide



Home Appliances

RV12EFR
RV15EFR

Thank you for choosing a Roper Appliance.

This Use and Care Guide will help you operate and maintain your new, quality-built Roper freezer. Keep this Use and Care Guide in a safe place for future reference.

Complete and mail the Product Registration Card.

This card enters your warranty into our warranty system that ensures efficient claim processing, can be used as a proof of purchase for insurance claims and helps Roper to contact you immediately in the unlikely event of a product-safety recall.

NOTE: Because this Use and Care Guide covers two models, not all features discussed will apply to your specific model.

You are responsible for

It is your responsibility to be sure your freezer:

- Is properly installed and leveled on a floor that will hold the weight, and in an area suitable for its size and use.
- Is properly connected to a grounded electrical circuit that meets the electrical requirements on page 2.
- Is used only for the job it was designed to do.
- Is not near an oven, radiator or other heat source.
- Is properly maintained.
- Is out of the weather.
- Is used in an area where the temperature will not exceed 110°F (43.3°C) or drop below 55°F (13°C).
- Is not used by children or anyone unable to operate it properly.
- Is not loaded with food before it has time to get properly cold.

Contents

	Page
Important Safety Instructions _____	2
Food Storage _____	2
Before Using Your Freezer _____	2
Parts And Features _____	3
Using Your Freezer _____	4
Setting the temperature control _____	4
Adjusting the temperature control _____	4
Refrigerated shelves _____	4
Lower storage gate _____	4
The key eject lock _____	4
Defrosting And Cleaning Your Freezer _____	5
Caring For Your Freezer _____	5
If electricity goes off _____	5
Moving _____	5
Before You Call For Service _____	6
Limited Domestic Food Loss Coverage _____	7
Warranty _____	8
How to get service or assistance _____	8

Important Safety Instructions

⚠ WARNING

To reduce the risk of fire, electrical shock, or injury when using your freezer, follow basic precautions including the following:

1. Read all operating instructions before using your freezer.
2. Child entrapment and suffocations are not problems of the past. Junked or abandoned freezers are still dangerous...even if they will "just sit in the garage for a few days."

If you are getting rid of your old freezer, do it safely. Please read the enclosed safety booklet from the Association of Home Appliance Manufacturers. Help prevent accidents.

3. Never allow children to operate, play with, or crawl inside the freezer.
4. Never clean freezer parts with flammable fluids. The fumes can create a fire hazard or explosion.

▪ **FOR YOUR SAFETY** ▪

DO NOT STORE OR USE GASOLINE OR OTHER FLAMMABLE VAPORS AND LIQUIDS IN THE VICINITY OF THIS OR ANY OTHER APPLIANCE. THE FUMES CAN CREATE A FIRE HAZARD OR EXPLOSION.

▪ **SAVE THESE INSTRUCTIONS** ▪

Food Storage

Your freezer is designed for storage of commercially frozen food and for freezing food at home. For further information about preparing food for freezing or food storage times, contact your local Cooperative Extension Service or check a freezer guide or cookbook.

Before Using Your Freezer

A. Remove packing materials

Remove materials, tape and inside labels before using the freezer. To remove any remaining glue:

- Rub briskly with thumb to make a ball, then remove.
- OR
- Soak area with liquid hand dishwashing detergent before removing glue as described above.

Do not use sharp instruments, rubbing alcohol, flammable fluids or abrasive cleaners. These can damage the material. See "Important Safety Instructions" at left.

NOTE: Do not remove the Tech Sheet located on the back of the freezer.

B. Install handle

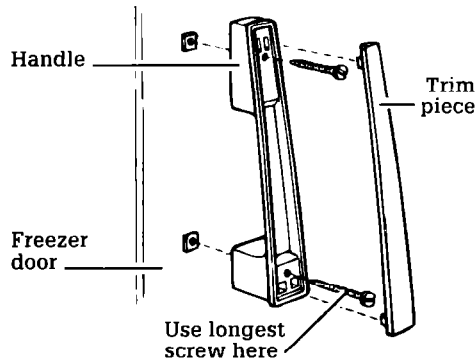

1. Remove screws from front of freezer door and discard.
2. Locate handle assembly kit among packing materials.
3. Attach top of handle to top hole in door with shorter of 2 screws provided.
4. Attach bottom of handle to lower hole in door with longer of 2 screws.
5. Snap trim piece into place.

C. Clean it

Clean your freezer before using it.

1. Use a sponge, cloth or paper towel and mild detergent in warm water to clean outside and inside of freezer, door liner and gasket.
2. Rinse and dry thoroughly.

D. Locate proper electrical supply

Recommended Grounding Method

A 115 Volt, 60 Hz., AC only 15 or 20 ampere fused and properly grounded electrical supply is required. It is recommended that a separate circuit serving only this appliance be provided.

Use a receptacle which cannot be turned off with a switch or pull chain. Do not use an extension cord.

Attach retaining clip, from literature package inside the freezer, over power cord plug.

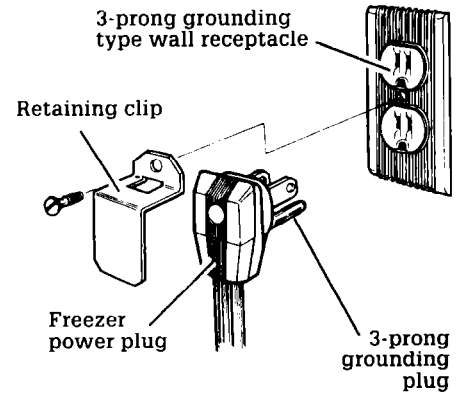

E. Choose freezer location

1. Pick a safe place, indoors, away from flammables such as gasoline.
2. Check the strength of the floor. It should hold the weight of a fully loaded freezer.
3. Allow at least 3 inches (7.5 cm) of air space at top of freezer.
4. Allow at least 1 inch (2.5 cm) between back of freezer and the wall.
5. Allow 3 inches (7.5 cm) on each side of the freezer for ease of installation.
6. If the freezer is to be against a wall, you might want to leave extra space on the hinge side so the door can be opened wider.

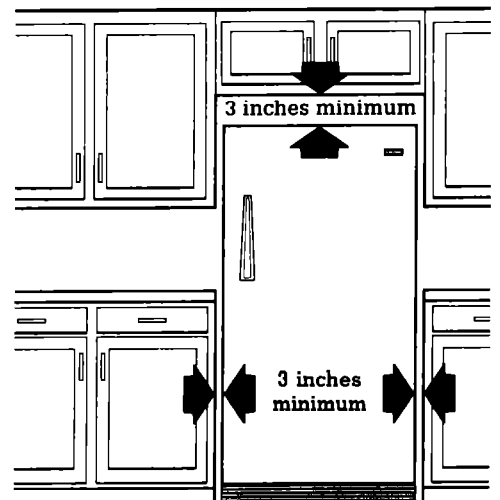

Parts And Features

Model RV12EFR

E. Install freezer

Level freezer so the door will stay open at any position.

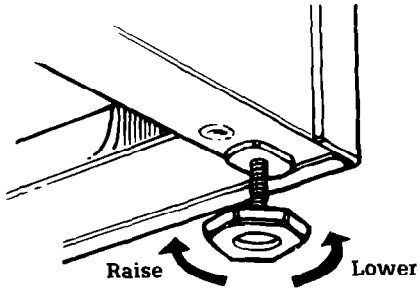

1. Locate, remove and discard the 4 bolts that held the freezer in the shipping crate.
2. Locate the 2 front leveling legs among the packing materials.
3. Screw these legs into the front holes on the bottom of the freezer. The back of the freezer rests on 2 fixed supports.
4. Adjust the 2 front legs so freezer does not rock.
5. Connect freezer to proper electrical supply and attach retaining clip. (Refer to "D. Locate proper electrical supply" on page 2.)
6. Slide freezer into place.
7. Place a level on top of the freezer – first side to side then front to back. Turn leg clockwise to raise a corner. Turn leg counter-clockwise to lower a corner.
8. Repeat step 7 until the freezer is level.
9. After freezer is fully loaded, recheck with level.

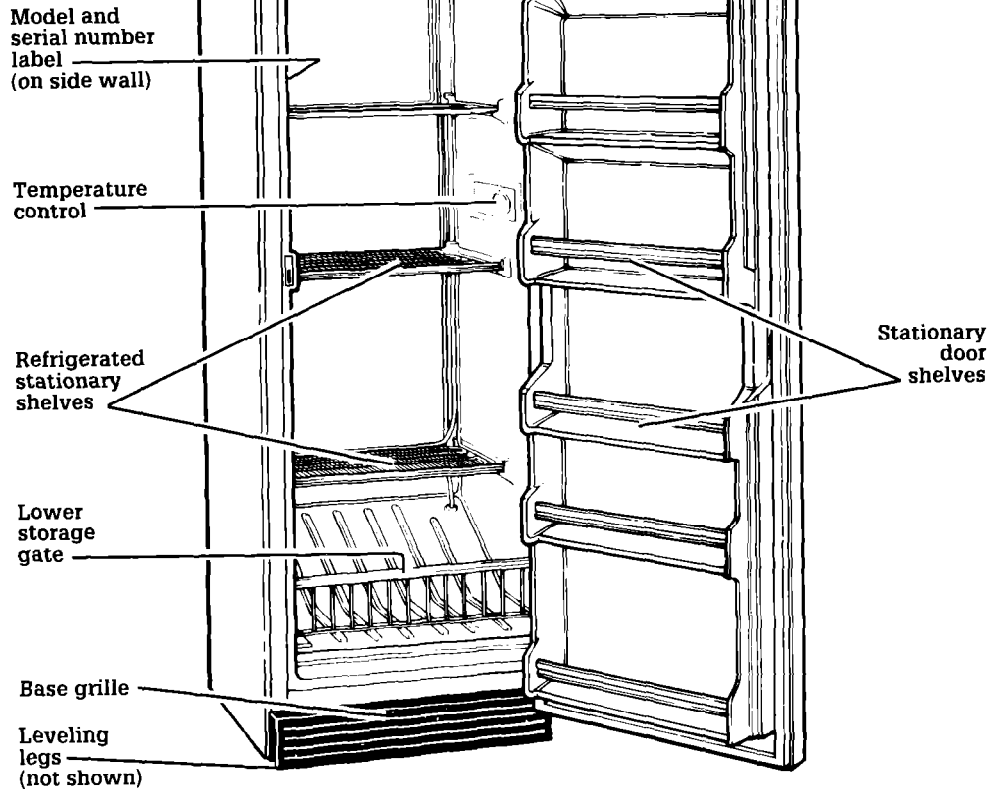

Model RV15EFR

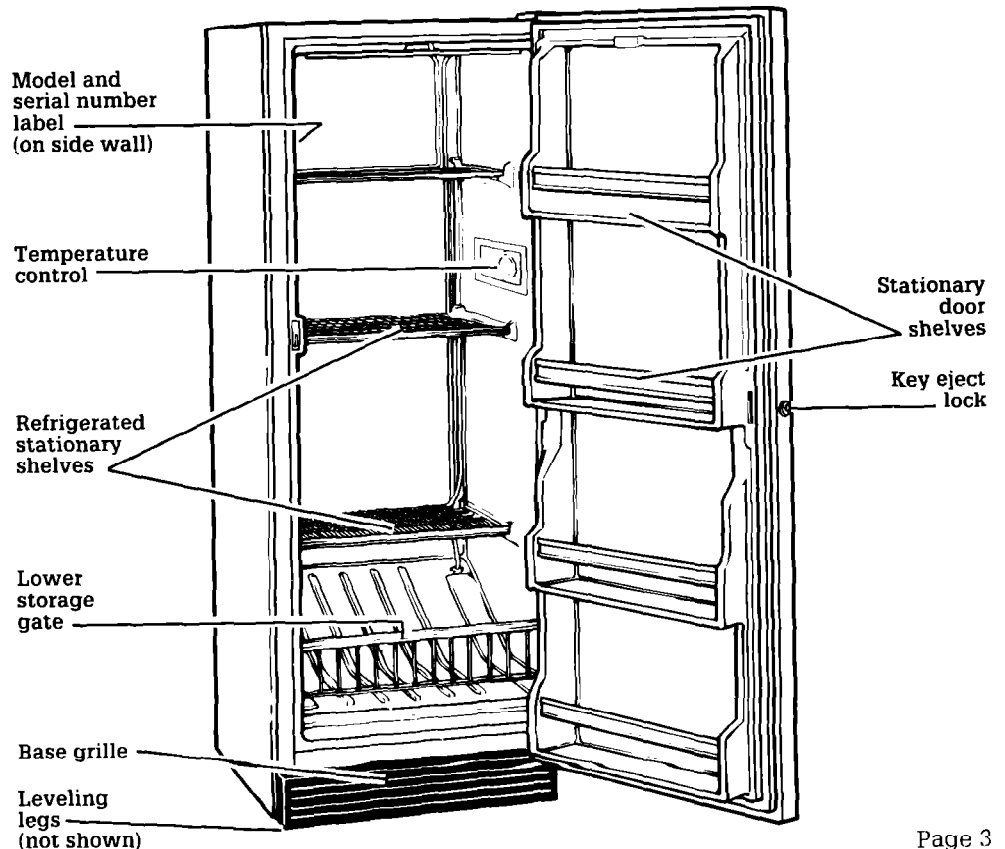

Using Your Freezer

Setting the temperature control

Turn the control to 4. This setting is designed to maintain the temperature at or near 0°F (-17.8°C) under normal operating conditions.

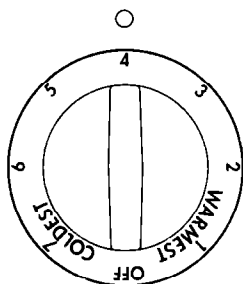

Allow the freezer to cool 6 to 8 hours before filling with **frozen food**. Let the freezer cool overnight before adding large amounts of **unfrozen food**. Never add more than 2-3 pounds of unfrozen food per cubic foot of freezer space.

NOTE: When the freezer is first started, the compressor will run constantly until the cabinet is cooled. It may take up to 6 to 8 hours or longer, depending on room temperature and the number of times the freezer door is opened.

After the cabinet is cooled, the compressor will turn on and off as needed to keep the freezer at the proper temperature.

The outside of your freezer may feel warm. This is normal. The freezer's design and main function is to remove heat from packages and air space inside the freezer. This heat is transferred to the room air, so the outside of the freezer may feel warm.

Adjusting the temperature control

- Turn control to a higher number for colder temperatures.
- Turn control to a lower number for less cold temperatures.

Refrigerated shelves

Your freezer is equipped with refrigerated interior shelves. Packages in direct contact with the shelves will have the best refrigeration. Fresh, unfrozen food packages should be stored directly on the shelves and not on top of already frozen food packages.

When placing the food packages in your freezer, it should be remembered:

- The cabinet shelves have the best freezing capability. The door shelves and the bottom of the cabinet have a slightly higher temperature. Therefore, packages sensitive to temperature (meat, poultry, etc.) should not be placed on the door shelves or the freezer bottom.
- Give the cold air a chance to completely surround the packages.

Lower storage gate

Pull top up, then forward.

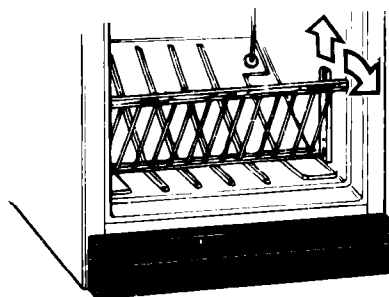

To lower gate:

1. Lift top of gate up slightly to clear supports.
2. Pull gate forward.

To raise gate:

1. Return gate to upright position.
2. Lift top of gate slightly to clear supports.
3. Lower gate into supports.

The key eject lock (model RV15EFR)

If your freezer is equipped with a lock, it can help reduce the hazard of child entrapment.

To lock or unlock the freezer, you must hold the key in the lock while turning. The lock is spring loaded, so the key cannot be left in the lock.

If the key is lost, contact your Roper dealer for a replacement. Always give the complete model and serial number of your freezer when requesting a replacement key.

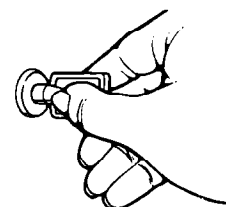

Defrosting And Cleaning Your Freezer

Defrost and clean your freezer when frost has built up to about 1/4 inch (6 mm) thickness. Complete defrosting and cleaning should be done at least once a year. In high humidity areas, a freezer may need more frequent defrosting and cleaning.

⚠ WARNING

Electrical Shock and Product Damage Hazard

- **Turning the Temperature Control to OFF does not remove power to the unit. Failure to unplug the power cord before cleaning or servicing unit could result in electrical shock.**
- **Do not place electrical devices in freezer when defrosting. Shock or injury can occur.**
- **Do not use an ice pick, knife or other sharp-pointed tool to defrost freezer. Damage can occur.**
- **Do not use abrasive cleaners on your freezer. Do not use cleaning waxes, concentrated detergents, bleaches or cleaners containing petroleum on plastic parts. Damage can occur.**

1. Turn Temperature Control to OFF and unplug power cord.
2. Remove all frozen food. Wrap frozen food in several layers of newspaper and cover with a blanket. Food will stay frozen for several hours.
OR
Store frozen food in a cooler, additional refrigerator-freezer, or in a cool area.
3. Place pans of hot water in freezer with door open to speed melting. Directing air from an electric fan into freezer will also help. **Do not place fan in freezer.**

4. Use a plastic scraper to remove frost.
5. Wipe water from walls and bottom of freezer with a towel or sponge.
6. Wash the inside walls with a solution of 2 tablespoons (26 mg) baking soda to 1 quart (0.95 L) warm water.
7. Rinse and dry thoroughly.
8. Use a sponge, cloth or paper towel and mild detergent in warm water to clean outside of freezer, door liner and gasket.
9. Rinse and dry thoroughly.
10. Wax painted metal surfaces outside of freezer to provide rust protection.
NOTE: Do not use wax on plastic parts. Wax may damage them.
11. Replace all frozen food.
12. Plug in power cord and refer to "Setting the temperature control" on page 4.

Caring For Your Freezer

If electricity goes off

1. **Call the power company.**
Ask how long power will be off.
2. **Keep freezer closed if service is to be interrupted 24 hours or less.**
This will help food will stay frozen.
3. **If service is to be interrupted longer than 24 hours, do this:**
Remove all frozen food and store in a frozen food locker.
OR
Place 2 lbs. (0.9 kg) of dry ice in freezer for every cubic foot of freezer space. This will keep foods frozen for 2 to 4 days.

⚠ WARNING

Personal Injury Hazard

Wear gloves to protect your hands from dry ice burns. Failure to do so could result in dry ice burns.

OR

If dry ice or a food locker is not available, use or can perishable food at once.

NOTE: A full freezer stays cold longer than a partly filled one. A freezer full of meat stays cold longer than a freezer full of baked goods.

Food containing ice crystals may be safely refrozen, but the quality and flavor of the food may be affected.

Use refrozen food quickly. If the condition of the food is poor, or you feel it is unsafe to eat, dispose of it immediately.

Moving

Remove all frozen food and pack it in dry ice. Unplug the freezer and clean it thoroughly. Tape the door shut and tape electrical cord to the cabinet.

When you get to your new home, refer to pages 2 and 3 for information on installation and setting controls.

Before You Call For Service

If you are having an operating problem, check the chart to see what the cause might be before you call for assistance.

OPERATING PROBLEM	CHECK IF	WHAT TO DO
<p>Freezer will not run.</p>	<ul style="list-style-type: none"> ▪ Power cord is plugged into a live circuit with proper voltage. ▪ House fuse has blown or circuit breaker has tripped. Also check if a time-delay fuse has been used. ▪ Electricity has failed. ▪ Temperature Control is turned on. 	<ul style="list-style-type: none"> ▪ Firmly plug power cord into electrical outlet. Check circuit voltage at fuse/circuit breaker box. ▪ Replace fuse with a time-delay fuse of the correct capacity. Reset circuit breaker. ▪ See "If electricity goes off" on page 5. ▪ Turn Temperature Control to a numbered position.
<p>Motor runs too long or temperature is too low.</p>	<ul style="list-style-type: none"> ▪ Power cord is plugged into a live circuit with proper voltage. ▪ Excessive frost or a package is holding the door open. ▪ Large amounts of unfrozen food have been added to the freezer. ▪ Weather is hot and muggy. ▪ There is enough air circulation space above and behind the freezer. 	<ul style="list-style-type: none"> ▪ Firmly plug power cord into electrical outlet. Check circuit voltage at fuse/circuit breaker box. ▪ Defrost freezer or reposition package. ▪ Add no more than 2 to 3 pounds of unfrozen food per cubic foot of freezer space at a time. Adding large amounts of unfrozen food will cause the motor to run longer. ▪ If the temperature outside or inside the room is warm, motor running longer is normal. Freezer should not be used in an area where the temperature exceeds 110°F (43.3°C). ▪ Allow at least 3 inches (7.5 cm) air space on top of freezer and 1 inch (2.5 cm) at back for proper air circulation.
<p>Freezer clicks but does not run.</p>	<ul style="list-style-type: none"> ▪ Electricity failed and has been restored. 	<ul style="list-style-type: none"> ▪ Unplug the freezer for 30 minutes to allow the refrigeration system to equalize.

Limited Domestic Food Loss Coverage Reimbursement For Food Losses

During the first year of ownership, the Roper Freezer warranty provides reimbursement as outlined below for food actually spoiled while stored in the freezer as a result of defects in materials or workmanship.

During the second through fifth years of ownership, reimbursement will be made as outlined below for food actually spoiled while stored in the freezer as a result of a **FAILURE OF THE SEALED REFRIGERATION SYSTEM**.

Food spoilage losses must be verified by Roper Brand Appliance warrantor or an authorized RoperSM service company. Reimbursement of losses will be based on domestic use up to the total cumulative amount of \$125.00 maximum payment for the five year warranty period.

This reimbursement amount may or may not cover the actual replacement cost of the contents of your freezer. It is the maximum amount, however, that will be paid and it is cumulative for the five year warranty period.

Sorry, but warrantor is not responsible for food losses caused by natural spoilage, misuse or negligent care of the freezer, or by accidental or intentional disconnecting of the electric power cord, power interruption, inadequate power, fire damage, water damage, theft, or riots, strikes, war or acts of God.

LIMITED WARRANTY



Home Appliances

LENGTH OF WARRANTY (From date of purchase)	PRODUCTS COVERED	WHAT WE WILL PAY FOR
FULL ONE YEAR WARRANTY	All Roper Appliances	Replacement parts and repair labor to correct defects in materials or workmanship.
FULL FIVE YEAR WARRANTY	Air Conditioners Dehumidifiers Refrigerators Freezers (See page 7 for details on limited domestic food loss protection plan.)	Replacement parts and repair labor for the sealed refrigeration system (compressor, evaporator, condenser, drier or connecting tubing) which we find to be defective in materials or workmanship.
LIMITED 2ND-5TH YEAR WARRANTY	Microwave Ovens	Repair or replacement of magnetron tube which we find to be defective in materials or workmanship.
LIMITED 2ND-5TH YEAR WARRANTY	Automatic Washers	Repair or replacement of any part of the gear case assembly which we find to be defective in materials or workmanship.

WHAT WE WILL NOT PAY FOR

- A. SERVICE CALLS TO:
1. Correct the installation of your appliance.
 2. Instruct you how to use your appliance.
 3. Replace house fuses or correct house wiring or plumbing.
 4. Replace owner accessible light bulbs.
- B. Repairs when appliance is used in other than normal, single-family household use.
- C. Pick up and delivery. Your appliance is designed to be repaired in the home.
- D. Damage to appliance caused by accident, misuse, fire, flood, acts of God, or use of product not approved by us.
- E. Any labor costs during the limited warranties.
- F. Food loss coverage for freezers used in commercial applications.

This Roper appliance is warranted by Whirlpool Corporation. Under no circumstances shall it be liable under this warranty for incidental or consequential damages and all implied warranties are limited to the same time periods stated in the express warranties for Roper Brand Appliances. Some states do not allow the exclusion or limitation of incidental or consequential damages or limitations of how long an implied warranty may last, so the above limitations or exclusions may not apply to you.

This warranty gives you specific legal rights, and you may also have other rights which vary from state to state.

Outside the United States, a different warranty may apply. For details, please contact your franchised Roper distributor or military exchange.

HOW TO GET SERVICE OR ASSISTANCE

If you need service, first see the "Before You Call For Service" section of this book. If you still need service after checking this section, additional help can be found if you:

- Contact your selling dealer for the authorized servicer in your area*
OR
- Phone **1-800-44-ROPER** (1-800-447-6737) between 8:00 a.m. and 4:30 p.m. Eastern Time, Monday through Friday*
OR
- For further information, write to: Consumer Relations Dept., Roper Brand Appliances, 2000 M-63 North, Benton Harbor, MI 49022*

*When requesting assistance, please provide the model and serial numbers, date of purchase, and a complete description of the problem. The model and serial numbers are located on a plate on the inside left wall of the unit. (See illustration on page 3.)

If you are not satisfied with the service received, contact the Major Appliance Consumer Action Panel (MACAP). MACAP is a group of independent consumer experts that voices consumer views at the highest levels of the major appliance industry.

Contact MACAP only when the dealer, authorized servicer or Roper Brand Appliance warrantor have failed to resolve your problem:

Major Appliance Consumer Action Panel
20 North Wacker Drive
Chicago, IL 60606

MACAP will in turn inform us of your action.

Part No. 1114927

©1991 Whirlpool Corporation

TM Trademark / SM Service Mark of Whirlpool Corporation

PRINTED IN U.S.A.

WCW 1-80764