

KitchenAidTM

*No-Frost
Refrigerator-Freezer*

**Superba Series
Models KRSR27Q
KSRB27Q**

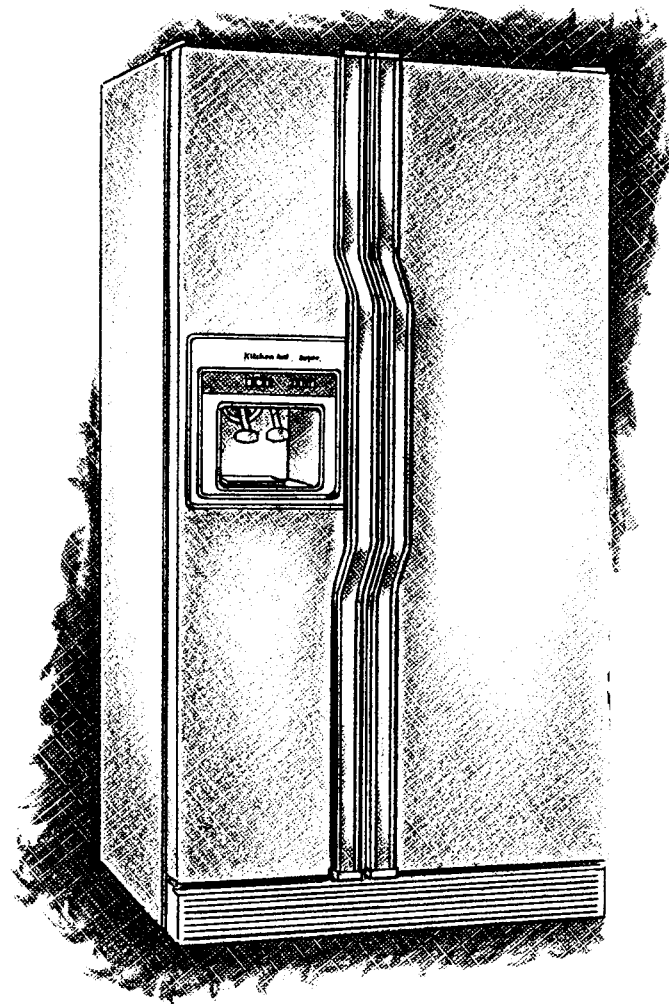

Table of Contents

	Page
Important Safety Instructions	3
Ownership Registration	4
Refrigerator-Freezer Features	5
Installing the Refrigerator-Freezer	6
Clean It	6
Plug It In	6
Locate Properly	6
Level Refrigerator-Freezer	6
Using the Refrigerator-Freezer	7-15
Temperature Controls	7
Power Saving Control	7
Refrigerator Shelves	8
Wine/Egg Rack	8
Door Bins	8
Can Dispenser	8
Crispers	9
Meat Locker	9
Meat Locker Temperature Control	9
Freezer Baskets	10
Base Grille	10
Defrost Pan	10
Changing the Light Bulbs	11
Ice Maker	12
Ice Maker Storage Bin	12
Cold Water and Ice Dispenser	13
Dispenser Operating Tips	14
Sounds You May Hear	15
To Save Energy	15
Food Storage Guide	16
Vacation and Moving Care	18
Cleaning the Refrigerator-Freezer	19
If You Need Service or Assistance	20
KitchenAid Freestanding Refrigerator Warranty	Back Cover

©1990 KitchenAid

Important Safety Instructions

⚠ WARNING

To reduce the risk of fire, electrical shock, or injury when using the refrigerator, follow basic precautions including the following:

- Read all instructions before using the refrigerator.
- Child entrapment and suffocation are not problems of the past. Junked or abandoned refrigerators are still dangerous...even if they will "just sit in the garage a few days."
If you are getting rid of your old refrigerator, do it safely. Please read the enclosed safety booklet from the Association of Home Appliance Manufacturers. Help prevent accidents.
- Never allow children to operate, play with, or crawl inside the refrigerator.
- Never clean refrigerator parts with flammable fluids. The fumes can create a fire hazard or explosion.

–FOR YOUR SAFETY–

DO NOT STORE OR USE GASOLINE OR OTHER FLAMMABLE VAPORS AND LIQUIDS IN THE VICINITY OF THIS OR ANY OTHER APPLIANCE. THE FUMES CAN CREATE A FIRE HAZARD OR EXPLOSION.

It is your responsibility to be sure your refrigerator:

- is installed and leveled on a floor that will hold the weight, and in an area suitable for its size and use.
- is connected only to the right kind of outlet, with the right electrical supply and grounding. (Refer to the Electrical Requirements and Grounding Instructions Sheet.)
- is used only to do what home refrigerators are designed to do.
- is not near an oven, radiator or other heat source.
- is properly maintained.
- is out of the weather.
- is used in an area where the room temperature will not fall below 55°F (13°C).
- is not used by anyone unable to operate it properly.
- is not loaded with food before it has time to get properly cold.

–SAVE THESE INSTRUCTIONS–

Ownership Registration

Please fill out and mail your Ownership Registration Card packed with the Literature Package. This card will enable us to contact you in the unlikely event of a product safety notification and assist us in complying with the provisions of the Consumer Product Safety Act. Return of this card is not necessary to validate your warranty.

You must provide proof of purchase or installation date for in-warranty service.

Write down the following information. You will need it if your refrigerator ever requires service.

Model Number* _____

Serial Number* _____

Date Purchased _____

Date Installed _____

Builder's or Dealer's Name _____

Address _____

Phone _____

*Model and serial numbers are located on a label on inside wall of refrigerator.

Refrigerator-Freezer Features

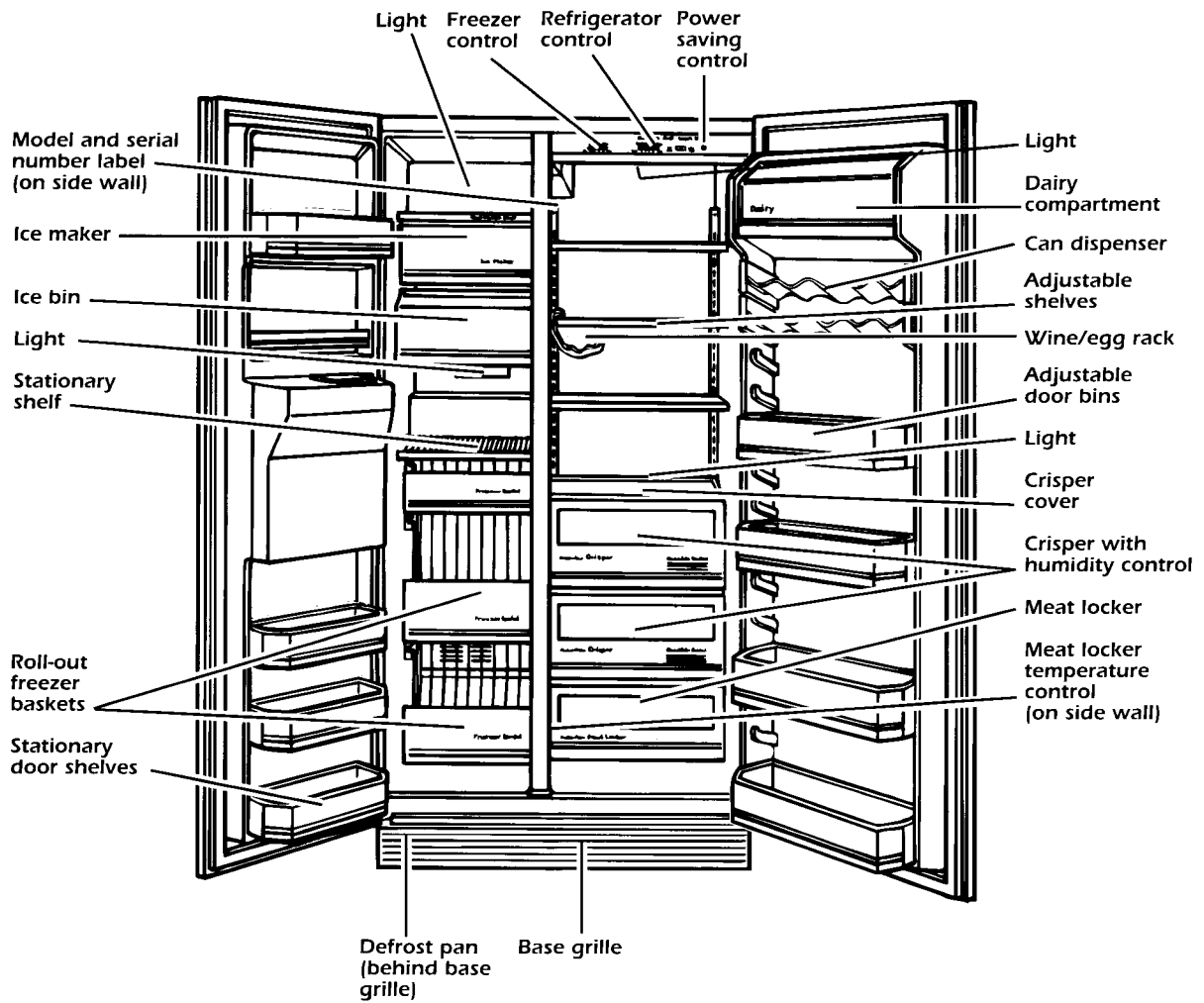

Installing the Refrigerator-Freezer

Clean It

Clean your refrigerator before using it. See cleaning instructions on page 19.

Remove the Consumer Buy Guide label and any shipping tape before using the refrigerator.

To remove any remaining glue:

1. Rub briskly with thumb to make a ball, then remove.
OR
2. Soak area with liquid hand dishwashing detergent before removing glue as described in step 1.

IMPORTANT: DO NOT USE sharp instruments, rubbing alcohol, flammable fluids or abrasive cleaners. These can damage the material. See "Important Safety Instructions" on page 3.

DO NOT REMOVE THE INSTRUCTION LABEL FOR SETTING THE CONTROLS INSIDE THE REFRIGERATOR.

DO NOT REMOVE the Tech Sheet fastened under the refrigerator, behind the base grille.

Plug It In

3-prong grounding type wall receptacle

3-prong grounding plug

Refrigerator power cord

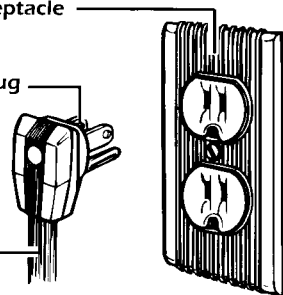

Recommended grounding method

A 115 Volt, 60 Hz., AC only, 15 or 20 Amp fused and properly grounded electrical supply is required. It is recommended that a separate circuit serving only this appliance be provided.

Do not use an extension cord. Use a receptacle which cannot be turned off with a switch or pull chain. See Electrical Requirements and Grounding Instruction Sheet in your Literature Package.

Locate Properly

1. Allow 1/2 inch (1.25 cm) on each side of the refrigerator for ease of installation.
2. If the refrigerator is to be against a wall, you might want to leave extra space on the hinge side so the door can be opened wider.
3. The refrigerator back can be flush against the wall.

Level Refrigerator-Freezer

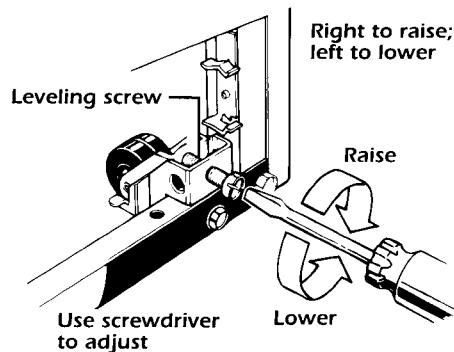

1. Remove base grille. (See page 10.)
2. To raise front, turn each screw clockwise.
3. To lower front, turn each screw counter-clockwise.
4. Check with level.
5. Replace base grille. (See page 10.)

Using the Refrigerator-Freezer

Temperature Controls

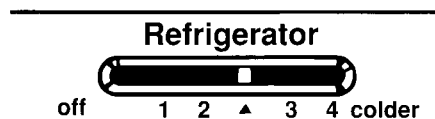

Refrigerator control

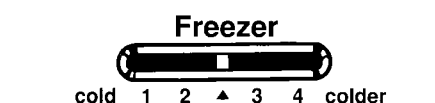

Freezer control

Controls for the refrigerator and freezer are in the refrigerator. When the refrigerator is first plugged in:

1. Move the Refrigerator Control to the triangle marking between numbers 2 and 3.
2. Move the Freezer Control to the triangle marking between numbers 2 and 3.

These settings should be about right for normal household refrigerator usage.

Give the refrigerator time to cool down completely before adding food. (This may take several hours.) The controls will be set about right when milk or juice is as cold as you like and when ice cream is firm.

To change the temperature setting, follow the steps given below:

1. Adjust the Refrigerator Control first.
2. Wait at least 24 hours before making further adjustments. This gives the refrigerator and/or freezer time to reach set temperature.
3. Adjust the Freezer Control, if necessary.

To make the refrigerator or freezer colder, slide the control(s) toward the number 4 setting(s). To make the refrigerator or freezer less cold, slide the control(s) toward the number 1 setting(s).

Changing either the Refrigerator Control or Freezer Control will affect the temperature of both compartments.

Use the settings listed in the chart below as a guideline when adjusting temperature controls:

CONDITION	RECOMMENDED CONTROL SETTING ADJUSTMENTS:	
If refrigerator section is too warm.	Refrigerator	3
	Freezer	2
If freezer section is too warm.	Refrigerator	3
	Freezer	3
If refrigerator section is too cold.	Refrigerator	2
	Freezer	3
If ice isn't made fast enough.	Refrigerator	3
	Freezer	3
If both sections are too warm.	Refrigerator	3
	Freezer	3

The following reasons can cause the conditions listed above:

- Door opened often.
- Large amount of food added.
- Room temperature too warm.
- Room temperature too cold. (Refrigerator doesn't cycle often enough.)
- Controls not set correctly for your conditions.
- Heavy ice usage.

Power Saving Control

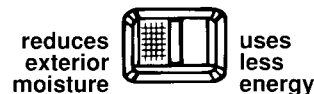

The **POWER SAVING CONTROL** on the Control Console operates electric heaters around the door openings. These heaters help keep moisture from forming on the outside of the refrigerator.

1. Use the **uses less energy** setting when humidity is low (indicator light off).
2. Use the **reduces exterior moisture** setting only if moisture forms on the outside of the refrigerator (indicator light on).

Refrigerator Shelves

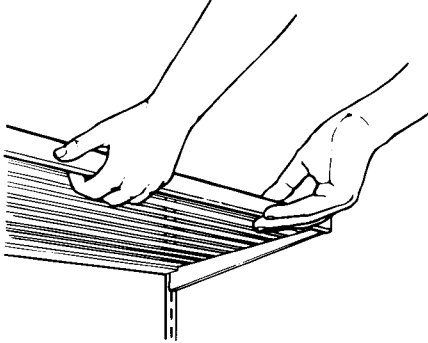

Shelves can be adjusted to match the way you use your refrigerator.

To remove:

1. Tilt up at front.
2. Lift up at back.
3. Pull shelf straight out.

IMPORTANT: Glass shelves are heavy. Handle with care.

To replace:

1. Guide the rear hooks into the slots in the shelf supports.
2. Tilt up front of shelf until hooks drop into slots. Lower front of shelf to level position. Check the stability of the shelf to be sure hooks have been properly inserted.

Wine/Egg Rack

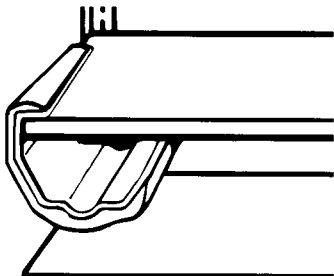

The rack is shaped to hold either a bottle of wine or a carton of eggs securely.

Door Bins

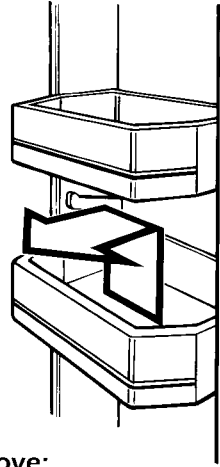

To remove:

1. Lift up bin.
2. Pull bin straight out.

To replace:

1. Hold back of bin above desired bin guide.
2. Push bin back and down until it stops.

Can Dispenser

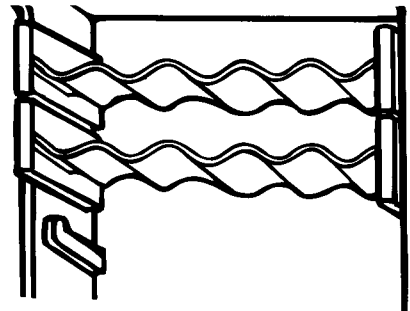

The dispenser is designed to hold cans in a convenient place, leaving more shelf space for larger items.

To remove:

1. Lift up dispenser.
2. Pull dispenser straight out.

To replace:

1. Hold back of dispenser above desired guide.
2. Push back and down until it stops.

Crispers

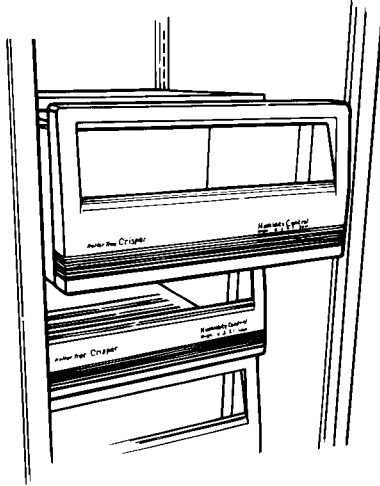

To remove crisper:

1. Roll out to the stop.
2. Lift front and pull out the rest of the way.

To replace:

1. Position back crisper rollers between front roller of track and track.
2. Push up and onto track.
3. Slide back until it stops.

To remove glass cover:

1. Remove crisper.
2. Tilt front of cover up.
3. Lift at back and pull straight out.

To replace:

Replace in reverse order.

IMPORTANT: Glass shelves are heavy. Handle with care.

Meat Locker

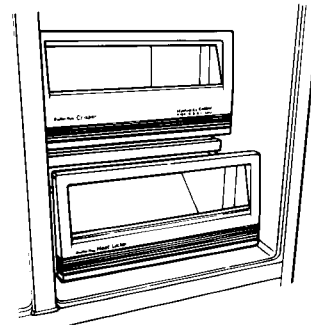

To remove meat locker:

1. Roll out to the stop.
2. Lift front and pull out the rest of the way.

To replace:

1. Position back rollers of meat locker between front roller of track and track.
2. Push up and onto track.
3. Slide back until it stops.

Meat Locker Temperature Control

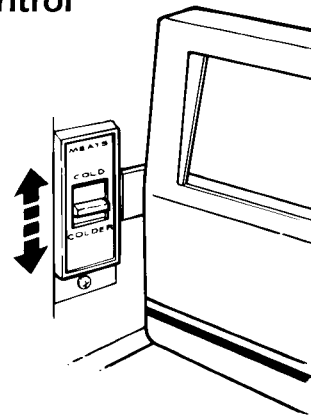

The Meat Locker Temperature Control allows you to adjust the meat locker storage temperature.

Cold air flows against the meat locker through an opening between the freezer and the refrigerator. Setting the control lets more or less cold air through the opening. This helps keep the meat locker colder than the rest of the refrigerator.

Freezer Baskets

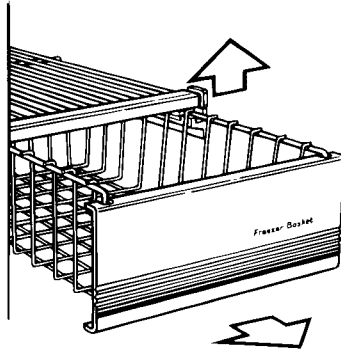

To remove:

1. Slide out basket to the stop.
2. Lift front to clear the stop.
3. Slide out the rest of the way.

To replace:

1. Place basket on the slides.
2. Lift front of basket to clear the stops.
3. Slide basket in.

Base Grille

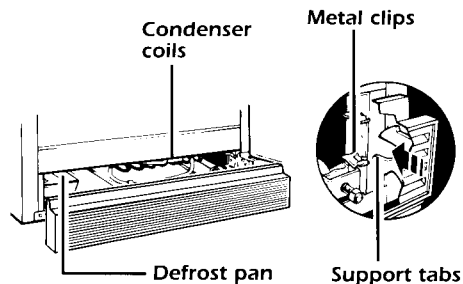

To remove base grille:

1. Open the refrigerator door.
2. Pull grille out.
3. **Do not remove Tech Sheet** fastened behind the grille.

To replace:

1. Line up grille support tabs with metal clips.
2. Push firmly to snap into place.
3. Close the refrigerator door.

See cleaning instructions for defrost pan and condenser coils on page 19.

Defrost Pan

⚠ WARNING

Personal Injury Hazard
Refrigeration system tubes are located above the defrost pan and can become hot. Remove and install defrost pan carefully. Failure to do so could cause personal injury.

To remove defrost pan:

1. Remove base grille. (See at left.)
2. Lift defrost pan over wire brace. Remove tape, if any.
3. Clean as described on page 19.

To replace:

1. Replace with notched corner to the rear.
2. Push pan in all the way. Make sure defrost drain tube is directed into pan.
3. Replace base grille. (See at left.)

Changing the Light Bulbs

⚠ WARNING

Electrical Shock Hazard
Before removing a light bulb, either unplug the refrigerator or disconnect the electricity leading to the refrigerator at the main power supply. Shock and injury can occur if electricity remains connected.

To change light bulb in refrigerator:

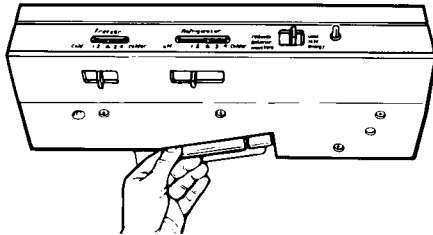

1. Disconnect refrigerator from power supply.
2. Reach behind the Control Console to find bulb.
3. Remove and replace bulb with a 40-watt tubular appliance bulb.
4. Reconnect power supply.

To change light bulb behind crisper:

1. Disconnect refrigerator from power supply.
2. Remove crisper and crisper cover. (See page 9.)
3. Remove and replace bulb with a 40-watt appliance bulb.
4. Reconnect power supply.

To change light above Fast Freeze Shelf:

1. Disconnect refrigerator from power supply.
2. Remove light shield by pulling top forward.
3. Remove and replace bulb with a 40-watt appliance bulb.
4. Replace the light shield.
5. Reconnect power supply.

To change light below ice bin:

1. Disconnect refrigerator from power supply.
2. Push in sides of light shield until it snaps free.
3. Remove and replace bulb with a 40-watt appliance bulb.
4. Replace the light shield.
5. Reconnect power supply.

To change dispenser light:

1. Disconnect refrigerator from power supply.
2. Remove the bulb from the top inside of the dispenser area.
3. Replace with a heavy-duty 10-watt bulb.
4. Reconnect power supply.

Ice Maker

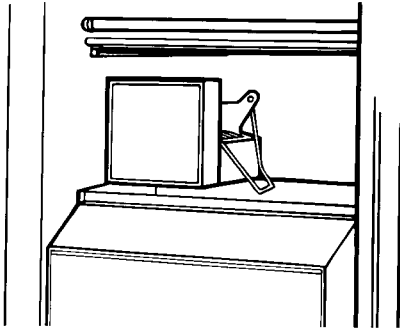

To start ice maker:

Push the ice maker signal arm down to the ON position.

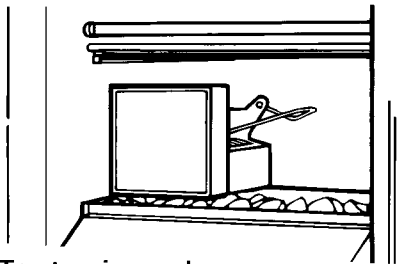

To stop ice maker:

Lift the ice maker signal arm until you feel it click into the OFF position.

Ice Maker Storage Bin

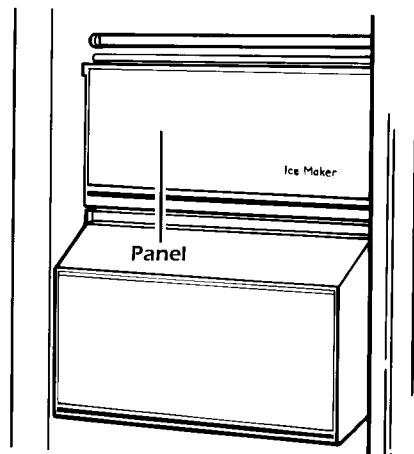

The ice maker storage bin can hold up to 8.5 pounds of ice. Remove unused ice periodically to reduce the potential for off-taste or odor build-up in ice.

IMPORTANT: The first few batches of ice from the ice maker may have an off-taste. This is from new plumbing and parts, and the ice should be thrown away.

To remove storage bin:

The storage bin can be removed to dispense large quantities of ice or for cleaning.

1. Pull the covering panel out from the bottom and slide it to the rear.
2. Lift the ice maker signal arm until you feel it click into the OFF position. Ice can still be dispensed when the freezer door is closed, but no more can be made.
3. Lift the front of the storage bin, then pull it out.
4. Empty the bin. Use hot or warm water to melt the ice if necessary. Never use anything sharp to break up ice in the bin. This can damage the bin and dispenser mechanism.
5. Wash with mild detergent. Rinse well. Do not use harsh or abrasive cleaners or solvents.

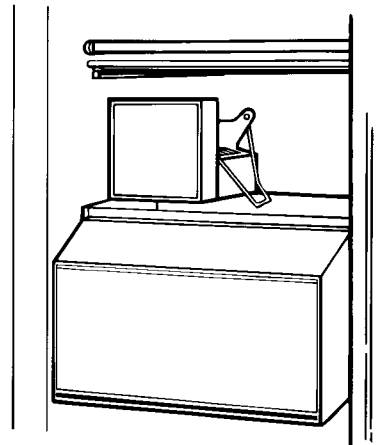

To replace storage bin:

1. Make sure bin is pushed in all the way.
2. Push the ice maker signal arm down to the ON position to restart ice production.
3. Lower covering panel.

Cold Water and Ice Dispenser

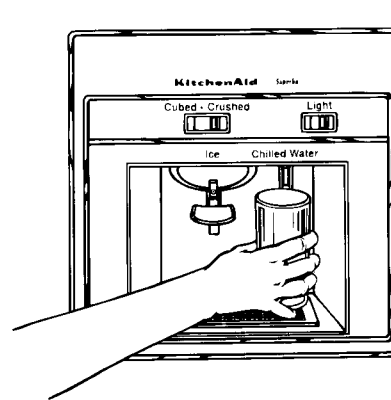
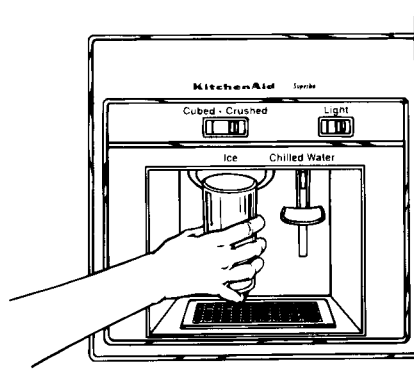

⚠ WARNING

Personal Injury Hazard
Tumbling ice and pressure on a fragile glass can break it. Do not use a fragile glass when dispensing ice or water. Failure to do so could result in personal injury or breakage.

To dispense ice:

Press a sturdy glass against the ice dispenser bar. Hold glass close to dispenser opening so ice does not fall outside of glass. Remove the glass to stop dispensing.

Ice is dispensed from the ice maker storage bin in the freezer. When the dispenser bar is pressed, a trap door opens in a chute between the dispenser and the ice bin. Ice is moved from the bin and falls through the chute. When the dispenser bar is released, a buzzing sound may be heard for a few seconds.

These models have cubed and crushed ice available. Before dispensing ice, select which type of ice you prefer.

For cubed ice, move Ice Selector Switch left to the cubed position. For crushed ice, move Ice Selector Switch right to the crushed position.

To dispense chilled water:

Press a sturdy glass against the water dispenser bar. Remove the glass to stop dispensing.

Chilled water comes from a 50 oz. tank behind the crisper drawers. Allow about 24 hours to chill the first tankful of water.

When the refrigerator is first hooked up, press the water dispenser bar with a glass or jar until you have drawn and discarded 2-3 quarts of water. This will remove the air in the system and rinse the tank and pipes.

If the dispenser is not used regularly, dispense enough water every week to freshen the supply. Allow 2-3 hours for the new supply of water to chill.

IMPORTANT: The small tray under the dispenser is designed to evaporate **small** spills. There is no drain in this tray. Do not pour water into it.

Dispenser Operating Tips

PROBLEM	CAUSE	SOLUTION
Dispenser won't work.	Freezer door open.	<ul style="list-style-type: none"> • Close the freezer door.
Ice Dispenser won't work.	<p>Ice bin not properly installed.</p> <p>Wrong ice in bin.</p> <p>Dispenser not used for extended periods, causing ice cubes to melt together.</p>	<ul style="list-style-type: none"> • Make sure bin is pushed in all the way. • Use only ice crescents from ice maker. Shake the bin occasionally to keep cubes separated, and to obtain increased storage capacity. • Dump old ice and make new supply.
Ice dispenser stops working.	Ice dispenser bar held in too long.	<ul style="list-style-type: none"> • Wait about 3 minutes for the dispenser motor to reset. • Large amounts of ice should be taken from the bin, not through the dispenser.
Off-taste or odor in ice.	<p>Ice attracts airborne odors; old ice.</p> <p>Water quality.</p> <p>Foods not properly wrapped.</p> <p>Ice bin and freezer may need cleaning.</p> <p>Plumbing to ice maker.</p> <p>New ice maker.</p>	<ul style="list-style-type: none"> • Dump old ice and make new supply; store excess ice in covered container. • Water containing minerals (such as sulfur) may require a filter to remove. • For best results, avoid connecting ice maker to a softened water supply. If softened water must be used, make sure the water softener is well maintained and operating properly. • Wrap properly in air and moisture proof materials. • Clean freezer and ice bin. See "Cleaning Chart" for instructions. • Follow Installation Instructions for proper ice maker water supply hook-up. • The first few loads of ice from a new ice maker may have an off-taste. Dump ice and make new supply.

Sounds You May Hear

Your new refrigerator may make different sounds than your previous one. Hard surfaces such as the ceiling, walls, and cabinets around the refrigerator can make sounds seem louder.

The following chart describes the kinds of sounds that might be new to you and what causes them.

SOUNDS/OBSERVATIONS	CAUSES
Hum or hiss	The refrigerator's fan motor and moving air.
Clicking or snapping sounds	The thermostat makes a definite click when the refrigerator stops running. It also makes a sound when the refrigerator starts. The defrost timer will click when the defrost cycle starts and stops.
Running sounds	The high-efficiency compressor and motor will run longer than older designs.
Trickling water/ water sounds	During the defrost cycle, the refrigerator will not be running. The trickling water is the frost accumulation on the freezer coil melting and running into the defrost pan. When the refrigerator stops running, you may hear gurgling in the tubing for a few minutes.

To Save Energy

- Open the doors as few times as possible. Keep food organized so you do not have to search for what you want. Get everything you need out at one time. Close the door as soon as food is removed.
- Set the refrigerator and freezer temperatures to suit your needs: ice cream should be firm and beverages should be as cold as you like them. Avoid setting the refrigerator and freezer temperatures colder than is necessary.
- Make sure your refrigerator is not next to a heat source such as a range, water heater, furnace, radiator, or in direct sunlight.
- Keep the **POWER SAVING CONTROL** in the **uses less energy** position unless moisture forms on refrigerator exterior (indicator light off).
- Check door gasket for tight seal. Level the cabinet to be sure of a good seal.
- Clean the condenser coils regularly.

Food Storage Guide

Fresh Food

Vegetables

- Leafy
Remove store wrapping. Tear off bruised and discolored areas. Wash in cool water, drain. Place in plastic bag or container and store in crisper.
- With skins
Place in plastic bags or containers and store in crisper.

Fruit

- Berries
Sort to remove injured berries. Do not wash berries until they are to be served. Store in original container in crisper.
- Other
Sort to remove injured fruit before storing. Wash fruit, let dry, place in perforated plastic bag or loosely covered plastic container and store in crisper.

Meat

- Cured or smoked meat and cold cuts
Store in original packaging until opened. When opened, tightly rewrap using plastic wrap or aluminum foil.
- Fresh, prepackaged meat & poultry
Store in original packaging.
- Fresh meat, not prepackaged
Remove market wrapping paper. Rewrap in aluminum foil.
- Fresh poultry, not prepackaged
Remove market wrapping paper. Rewrap in plastic wrap.
- Cooked meat & poultry
Wrap or cover with plastic wrap or aluminum foil. Store immediately.
- Fresh fish & shellfish
Store in plastic bag or tightly covered container.

Eggs

Store in original carton. For best storage, place on interior shelf or in wine/egg rack.

Dairy Products

- Milk
Store in original container on refrigerator shelf.
- Butter or margarine
Store in the dairy compartment or on refrigerator shelf until opened. When opened, store in covered dish or on butter dish in the dairy compartment.
- Cheese
Store in original packaging until opened. When opened, tightly rewrap in plastic wrap or aluminum foil and store in dairy compartment or on refrigerator shelf.

Leftovers

Cover with plastic wrap or aluminum foil, or place in plastic containers with tight fitting lids.

Condiments

Store small jars and bottles in door bins.

Beverages

Wipe off bottles and cans. Store in door bins or on refrigerator shelves.

REFRIGERATOR STORAGE CHART FOR FRESH AND CURED MEAT*

Type	Approximate Time (Days)
Chicken	1 to 2
Ground beef	1 to 2
Variety meat	1 to 2
Steaks and roasts	3 to 5
Cold cuts	3 to 5
Bacon	5 to 7
Cured meat	7 to 10

* If meat is to be stored longer than the times given, freezing is recommended.

IMPORTANT: Fresh fish and shellfish should be used the same day as purchased.

Frozen Food

Prepackaged frozen food

Store in original packaging on freezer door shelf or on freezer shelf.

Meat/poultry

Trim off excess fat and remove bones when necessary. Meat/poultry should not be salted. Wrap tightly in heavy-duty aluminum foil, plastic-coated wrapper, or non-permeable plastic wraps (made from a saran film). Press out as much air as possible. Label and date the meat/poultry. Do not refreeze thawed meat.

Ice Cream

Store in original packaging. When opened, place piece of aluminum foil or waxed paper against ice cream surface to prevent the formation of ice crystals.

Frozen juices

Store in original container on freezer door shelf or on freezer shelf.

STORAGE CHART FOR FROZEN FOOD*

Type	Approximate Time (Months)
Bread	2
Cooked dishes	2 to 3
Fish and seafood	
• fresh	6
• commercially frozen	1 to 3
Fruit	6
Ice cream	1
Concentrated juice	4 to 6
Meat	
• bacon	less than 1
• pork roast, chops	3 to 4
• sausage	1 to 2
• beef, veal, lamb roasts	6
• ground meat	1 to 2
• poultry	3 to 4
Vegetables	6

*Storage times given in this chart are only a guide. For best use of freezer space, keep frozen food for short times. Use, then replace as needed.

Courtesy of National Livestock & Meat Board and U.S.D.A.

Vacation and Moving Care

Short Vacations

If you will be away for less than four weeks, there is no need to shut off the refrigerator. Use up perishables and freeze other items. Turn off the automatic ice maker, then shut off the water supply to the ice maker. Empty the ice bin.

Long Vacations

Remove all food if you will be gone a month or more. Turn off the water supply to the ice maker at least one day before you leave.

When the last load of ice drops into the bin, turn the ice maker off. Turn the refrigerator-freezer off. (See "Temperature Controls" on page 7.)

Unplug the refrigerator and clean it...rinse well and dry. Tape rubber or wood blocks to the tops of both doors...keeping them open far enough for air to get in. This will keep odor and mold from building up.

Moving

Turn off the water supply to the ice maker at least one day before you move. When the last load of ice drops into the bin, turn the ice maker off. Empty the bin.

Remove all food and pack it in dry ice. Unplug the refrigerator and clean it thoroughly...rinse well and dry. Take out all removable parts. Wrap all parts well and tape them together so they don't shift and rattle. Screw in the leveling rollers,

WARNING

Personal Injury Hazard

Do not allow children to climb on, play near or crawl inside the refrigerator when the doors are blocked open. They may become injured or trapped.

To restart the refrigerator, see "Using the Refrigerator-Freezer" on page 7.

Cleaning the Refrigerator-Freezer

The refrigerator and freezer sections defrost automatically. However, both should be cleaned once a month to help prevent odors from building up. Spills should be wiped up immediately.

To clean, turn the Refrigerator Control to off, unplug it, take out all removable parts, and clean the refrigerator according to the directions given below.

Cleaning Chart

PART	WHAT TO USE	HOW TO CLEAN
Removable parts (shelves, crispers, etc.)	<ul style="list-style-type: none"> • Sponge or cloth • Mild detergent and warm water 	<ul style="list-style-type: none"> • Wash with warm water and mild detergent. • Rinse and dry well.
Exterior surfaces	<ul style="list-style-type: none"> • Sponge, soft cloth or paper towel • Mild detergent • Appliance wax or good auto paste wax 	<ul style="list-style-type: none"> • Wash with warm water and mild detergent. • Do not use abrasive or harsh cleansers. • Rinse and dry well. • Wax painted metal surfaces at least twice a year with appliance wax or a good auto paste wax. Apply wax with a clean, soft cloth. Waxing painted metal surfaces provides rust protection. • Do not use wax on plastic parts.
Interior walls	<ul style="list-style-type: none"> • Sponge, soft cloth or paper towel • Mild detergent • Warm water 	<ul style="list-style-type: none"> • Wash with warm water and mild detergent. • Rinse and dry well.
Door liners and gaskets	<ul style="list-style-type: none"> • Sponge, soft cloth or paper towel • Mild detergent • Warm water 	<ul style="list-style-type: none"> • Wash with warm water and mild detergent. • Rinse and dry well. • Do not use cleaning waxes, concentrated detergents, bleaches, or cleaners containing petroleum or alcohol on plastic parts.
Panels		<ul style="list-style-type: none"> • Clean as you would your kitchen cabinets.
Base grille	<ul style="list-style-type: none"> • Vacuum cleaner with brush attachment 	<ul style="list-style-type: none"> • Vacuum grille with brush attachment.
Defrost pan	<ul style="list-style-type: none"> • Sponge or cloth • Mild detergent • Warm water 	<ul style="list-style-type: none"> • See page 10 for removal and replacement instructions. • Wash defrost pan with warm water and mild detergent. • Rinse and dry well.
Condenser coils	<ul style="list-style-type: none"> • Vacuum cleaner with extended narrow attachment 	<ul style="list-style-type: none"> • Should be cleaned periodically. • Remove base grille. (See page 10.) • Vacuum using extended narrow attachment. • Replace base grille.

If You Need Service or Assistance

Follow These Steps

1. If the refrigerator should fail to operate, review the following list before calling your dealer. You could save the cost of a service call.

If the refrigerator will not operate:

- Is the electric cord plugged in?
- Is a fuse blown or circuit breaker tripped?
- Is the Refrigerator Control in the off position?

If the refrigerator makes unfamiliar sounds:

- New features on your refrigerator make new sounds. You may be hearing air flowing from fans, timer clicks for the defrosting cycle, or defrost water draining into the defrost pan. See page 15.

If there is water in the defrost pan:

- This is normal in hot, muggy weather. The pan can even be half full. Make sure the refrigerator is level so the pan does not overflow.

If the lights are not working:

- Is a fuse blown or circuit breaker tripped?
- Is a light bulb burned out? See instructions for changing light bulbs on page 11.

If the motor seems to run too long:

- The motor naturally runs longer on hot days or if the room is warm, as well as when a large amount of food has been put into the refrigerator or the doors have been opened a lot.

2. If the problem is not due to one of the above items:*

- Call KitchenAid Consumer Relations, TOLL-FREE:

1-800-422-1230

and talk with one of our trained consultants. The consultant can

instruct you in how to obtain satisfactory operation from your appliance or, if service is necessary, recommend a qualified service company in your area.

- If you prefer, write to:

Consumer Relations Department
KitchenAid

P.O. Box 558

St. Joseph, MI 49085-0558

Please include a daytime phone number in your correspondence.

3. If you need service:*

- Call your dealer or the repair service he recommends.
- All service should be handled locally by the dealer from whom you purchased the unit or an authorized KitchenAid servicer.
- If you are unable to obtain the name of a local authorized KitchenAid servicer, call our service assistance number (see Step 2).

4. If you are not satisfied with the action taken:*

- Contact the Major Appliance Consumer Action Panel (MACAP). MACAP is a group of independent consumer experts that voices consumer views at the highest levels of the major appliance industry.
- Contact MACAP only when the dealer, authorized servicer, or KitchenAid have failed to resolve your problem.

Major Appliance Consumer
Action Panel

20 North Wacker Drive
Chicago, IL 60606

- MACAP will in turn inform us of your action.

* When requesting assistance, please provide: Model Number, Serial Number, Date of Purchase and a complete description of the problem. This information is needed in order to better respond to your request.

KitchenAid™

Freestanding Refrigerator Warranty

LENGTH OF WARRANTY:	KITCHENAID WILL PAY FOR:	KITCHENAID WILL NOT PAY FOR:
ONE YEAR FULL WARRANTY FROM DATE OF PURCHASE.	Replacement parts and repair labor costs to correct defects in materials or workmanship. Service must be provided by an authorized KitchenAid servicing outlet.	A. Service calls to: 1. Correct the installation of the refrigerator. 2. Instruct you how to use the refrigerator. 3. Replace house fuses or correct house wiring. 4. Correct house plumbing.
SECOND THROUGH FIFTH YEAR FULL WARRANTY FROM DATE OF PURCHASE.	Replacement parts and repair labor costs to correct defects in materials or workmanship in the sealed refrigeration system. These parts are: 1. Compressor 2. Evaporator 3. Condenser 4. Drier 5. Connecting Tubing Service must be provided by an authorized KitchenAid servicing outlet.	B. Repairs when refrigerator is used in other than normal home use. C. Damage resulting from accident, alteration, misuse, abuse, improper installation or installation not in accordance with local electrical or plumbing codes. D. Any food loss due to product failure. E. Any labor costs during the limited warranty.
SIXTH THROUGH TENTH YEAR LIMITED WARRANTY FROM DATE OF PURCHASE.	Replacement parts to correct defects in materials or workmanship in the sealed refrigeration system. These parts are: 1. Compressor 2. Evaporator 3. Condenser 4. Drier 5. Connecting Tubing	F. Replacement parts or repair labor costs for units operated outside the United States. G. Pick up and delivery. This product is designed to be repaired in the home.
SECOND THROUGH FIFTH YEAR FULL WARRANTY FROM DATE OF PURCHASE.	Replacement or repair of the refrigerator/freezer cavity liner if the part cracks due to defective material or workmanship. Service must be provided by an authorized KitchenAid servicing outlet.	

KITCHENAID DOES NOT ASSUME ANY RESPONSIBILITY FOR INCIDENTAL OR CONSEQUENTIAL DAMAGES. Some states do not allow the exclusion or limitation of incidental or consequential damages, so this exclusion or limitation may not apply to you.

This warranty gives you specific legal rights and you may also have other rights which vary from state to state.

If you need service, first see the "Service and Assistance" section of this book. After checking "Service and Assistance," additional help can be found by calling our service assistance telephone number, **1-800-422-1230**, from anywhere in the U.S.