

Amana[®]

Self-Cleaning Electric Range Use & Care Manual

TABLE OF CONTENTS

IMPORTANT SAFETY INSTRUCTIONS.....	1-4
RANGE FEATURES	5
QUICK REFERENCE INSTRUCTIONS	6
HOW TO USE THE COOKTOP	7,8
USING THE OVEN.....	9
SETTING THE OVEN FOR DELAYED BAKING	10
OVEN BAKING GUIDES	11-13
SOLUTIONS TO BAKING PROBLEMS	14
USING THE BROILER	15,16
BROILING CHART	16
SELF CLEANING THE OVEN.....	17-19
TO INTERRUPT THE SELF CLEANING CYCLE...	19
CLEANING THE RANGE	20
CARE AND MAINTENANCE.....	21-22
COMMONLY ASKED QUESTIONS	23
HOW TO ADJUST THE OVEN TEMPERATURE...	24
SERVICE TONES.....	24
BEFORE YOU CALL A SERVICE PERSON.....	25

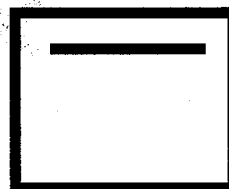

Model
ARR629

Please Read Before Operating Oven

IMPORTANT SAFETY INSTRUCTIONS

READ BEFORE OPERATING YOUR RANGE

1. Be sure your appliance is properly installed and grounded by a qualified technician.
2. Never use your appliance for warming or heating the room.
3. Do not leave children alone or unattended while the range is in operation. They should never be allowed to sit or stand on any part of the appliance.
4. **Wear Proper Apparel** - Loose-fitting or hanging garments should never be worn while using the appliance.
5. **User Servicing** - Do not repair or relace any part of the range unless specifically recommended in this manual. All other servicing should be referred to an authorized technician.
6. **Storage in or on Appliance** - Flammable materials should not be stored in an oven or near surface elements.
7. **Do Not Use Water on Grease Fires** - Smother fire or flame with a non-flammable lid, or use dry chemical or foam-type extinguisher.
8. **Use Only Dry Potholders** - Moist or damp potholders on hot surfaces may result in burns from steam. Do not let potholder touch hot heating elements. Do not use a towel or other bulky cloth.

Surface Cooking Units

1. **Use Proper Pan Size** - This appliance is equipped with one or more surface units of different sizes. Select utensils having flat bottoms large enough to cover the surface unit heating element. The use of undersized utensils will expose a portion of the heating element to direct contact and may result in ignition of clothing. Proper relationship of utensil to burner will also improve efficiency.
2. **Never leave Surface Units Unattended at High Heat Settings** - Boilover causes smoking and greasy spillovers that may ignite.
3. **Utensil Handles Should Be Turned Inward and Not extend Over Adjacent Surface Units** - To reduce the risk of burns, ignition of flammable materials, and spillage due to unintentional contact with the utensil, the handle of a utensil should be positioned so that it is turned inward, and does not extend over adjacent surface units.
4. **Glazed Cooking Utensils** - Only certain types of glass, glass/ceramic, ceramic, earthenware, or other glazed utensils are suitable for range-top service without breaking due to the sudden change in temperature.

Ovens

1. **Use Care When Opening Door** - Let hot air or steam escape before removing or replacing food.
2. **Do Not Heat Unopened Food Containers** - Build up of pressure may cause container to burst and result in an injury.
3. **Keep Oven Vent Ducts Unobstructed.**
4. **Placement of Oven Racks** - Always place oven racks in desired location while oven is cool. If rack must be moved while oven is hot, do not let potholder contact hot heating element in oven.

IMPORTANT SAFETY INSTRUCTIONS CONT.

Self Cleaning Oven

1. **Do Not Clean Door Gasket** - The door gasket is essential for a good seal. Care should be taken not to rub, damage, or move the gasket.
2. **Do Not Use Oven Cleaners** - No commercial oven cleaner or oven liner protective coating of any kind should be used in or around any part of the oven.
3. **Clean Only Parts Listed In This Manual.**
4. **Before Self Cleaning the Oven** - Remove broiler pan, other utensils, and oven racks.

Conventional Coil Cooking Surfaces

1. **Clean Cooktop with Caution** - If a wet sponge or cloth is used to wipe spills off a hot cooking area, be careful to avoid steam burns. Some cleaners can produce noxious fumes if applied to a hot surface.
2. **Make Sure the Burner Bowls or Reflector Pans Are in Place.** If they are not in place during cooking you may subject wiring or components underneath to damage.
3. **Do not use aluminum foil to line surface unit burner bowls or oven bottoms, except as suggested in the Use and Care Manual.** Improper installation of these liners may result in a risk of electric shock or fire.
4. **Do Not Soak Removable Coil Heating Elements.** The elements should not be immersed in water.

Ventilating Hoods

1. **Clean Ventilating Hoods Frequently** - Grease should not be allowed to accumulate on hood or filter.
2. When flaming foods under the hood, turn the fan off. The fan, if operating, may spread the flame.

IN CASE OF FIRE

Fires can occur as a result of over cooking or excessive grease. Though a fire is unlikely, if one occurs proceed as follows:

Surface Element Fire

1. **DO NOT turn on a range vent hood.** The flames could be drawn into the hood where more damage could result.
2. Smother the fire with a non-flammable lid or baking soda, or use a Class "ABC" or "BC" extinguisher. Not water. Not salt. Not flour.
3. As soon as it is safe to do so, turn the surface element controls to "OFF."

Oven Fires

1. If you see smoke from your oven, **do not open the door.**
2. Turn the oven control to "OFF"
3. As an added precaution, turn off the power at the main circuit breaker or fuse box.
4. Turn on the range vent hood or exhaust fan, if you have one, to remove smoke.
5. Allow food or grease to burn itself out in the oven.

OF COURSE, IF SMOKE AND FIRE PERSIST, CALL THE FIRE DEPARTMENT.

If there is any damage to components, call your repair service before using the range or cooktop again.

IMPORTANT PRECAUTIONS

- Do not cook food directly on the cooktop surface; always use cookware.
 - Do not mix household cleaning products. Chemical mixtures may interact, with objectionable or even hazardous results.
 - Do not put plastic items on warm cooking areas. They will stick and melt.
 - Do not slide rough metal objects across rangetop surface. Scratching or metal marking can result.
 - Do not use cookware with rough bottoms. They may scratch the surface of the element. Glass and glass-ceramic cookware can be used on coil elements.
 - Do not use a sponge or dishcloth to clean the rangetop. A film of soil-laden detergent water may collect on the rangetop. If this should happen, Amana ASAP™ Cleaner-Conditioner will remove the stain.
 - Do not leave fat heating unless you remain nearby. Fat can ignite if overheated by spilling onto hot surfaces.
 - Do not allow pans to boil dry on high settings as this can cause damage to the cooking surface and the pan.
 - Do not use the rangetop surface as a cutting board.
-

CONGRATULATIONS!

You have purchased an appliance that when operated correctly, should give you years of top quality performance. Your range was designed with safety in mind to give you cooking convenience and enjoyment. Read this book carefully before operating your new range and keep it nearby to refer to when necessary.

For future reference, record basic range information found on your range serial plate and retain a copy of your sales receipt for proof of purchase. The product serial plate is located on the oven frame below the oven door. (Open the oven door to see the serial plate.)

1. Model Number _____ Serial Number _____
Color _____ Manufacturing No. _____
2. Dealer's Name _____ Phone Number _____
Address _____
3. Date Purchased _____ Date Installed _____
4. Installer's Name _____ Phone _____
Address _____
5. Dealer Recommended Service Center _____
Phone _____
Address _____

RANGE FEATURES

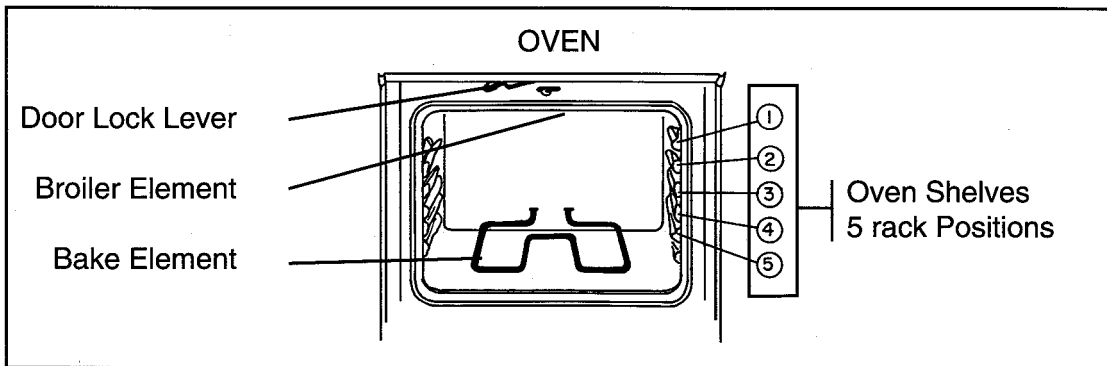

CONTROL KNOBS

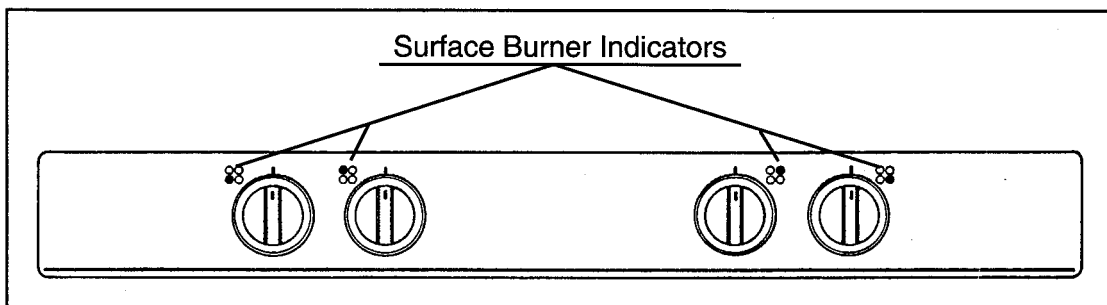

CLOCK DISPLAY

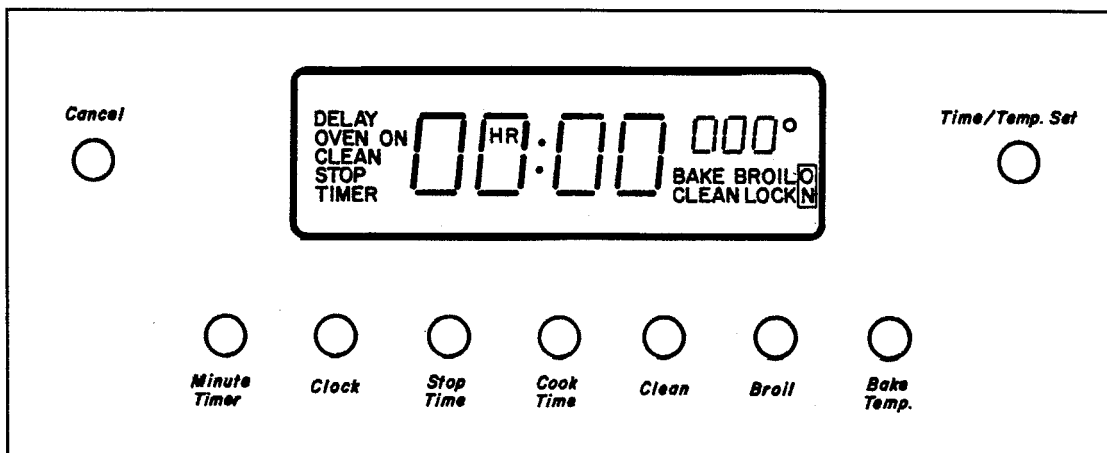

QUICK REFERENCE INSTRUCTIONS

Congratulations on the purchase of your new range. We have made every effort to make this range easy to learn and easy to use. To secure the maximum performance from your range it should be installed and used according to the safety instructions. The instructions below have been prepared as a quick reference. If you have any problems or unanswered questions, while using these directions, refer to the detailed sections in your use and care manual.

MAKE SURE YOU HAVE READ ALL OF THE SAFETY INSTRUCTIONS BEFORE YOU BEGIN TO OPERATE YOUR RANGE.

CLOCK AND OVEN CONTROLS

SETTING THE CLOCK

1. Push the Clock Button.
2. Turn the Time/Temp Set knob to the desired time of day.

SETTING THE MINUTE TIMER

1. Push the Minute Timer button.
2. Turn the Time/Temp Set knob to the desired amount of time. The timer can be set from 5 seconds to 11 hours and 59 minutes.



IMPORTANT

To Cancel the Minute Timer PUSH the Minute Timer button and hold it down for 3 seconds.

Pressing the cancel button will cancel a cooking function.

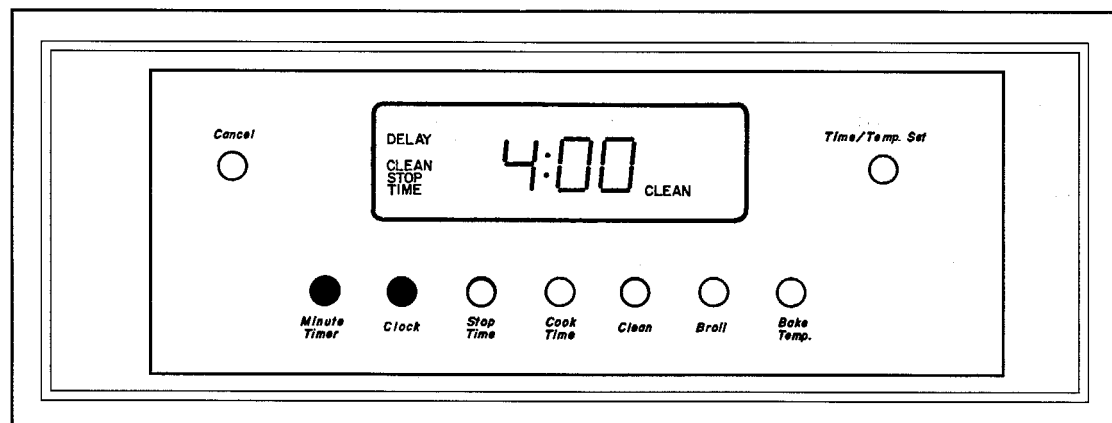

BAKING AND BROILING

1. Push the button that corresponds with the function you desire.
2. Turn the TIME/TEMP set knob to adjust the temperature.
3. After 3 seconds the oven will start.

SETTING DELAYED BAKE

1. Push the BAKE button.
2. Turn the TIME/TEMP knob to the desired temperature.
3. Push the COOK TIME button.
4. Turn the TIME/TEMP set knob to the desired cooking time.
5. Push the STOP TIME BUTTON.
6. Turn the TIME/TEMP knob to the desired stopping time.

HOW TO USE THE COOKTOP

1. USE THE PROPER PAN SIZE

Select utensils that have flat bottoms large enough to cover the element. Using undersized utensils will expose a portion of the burner to direct contact with clothing or spillovers. A utensil that is correctly sized will also improve efficiency.

2. NEVER LEAVE SURFACE UNITS UNATTENDED

At high heat settings boilovers can cause smoking or fire.

3. GLAZED COOKING UTENSILS

Only certain types of glass, glass/ceramic, earthenware or other glazed utensils are suitable for use with range top. Due to the sudden change in temperature some glazed utensils may break.

4. UTENSIL HANDLES SHOULD BE TURNED INWARD

A handle that extends away from the range could be unintentionally tipped.

COOKING UTENSILS

GLASS-CERAMIC cookware responds slowly to temperature changes. It responds best to long and slow heating of liquids.

ALUMINUM Responds quickly to temperature changes. It responds best for frying, braising and roasting.

CAST IRON responds slowly to temperature changes. It responds best for long low heat cooking and pan frying.

STAINLESS STEEL is usually combined with another metal such as copper, to better respond to temperature changes. It may be used for soups, sauces, vegetables and general cooking.

COPPER, TIN-LINED cookware responds quickly to temperature changes. It is excellent for gourmet cooking, wine sauces and egg dishes.

ENAMELWARE is stain resistant porcelain over metal. The cooking time can be determined by the base metal, however, lower temperatures are usually recommended. Choose utensils with...

- FLAT BOTTOMS AND STRAIGHT SIDES
- HANDLE WEIGHT THAT DOES NOT TILT THE PAN
- MATCH THE PAN SIZE TO THE BURNER SIZE

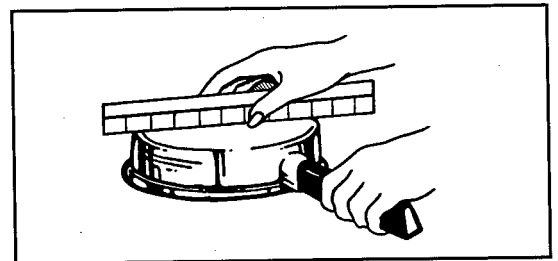

⚠ CAUTION

To avoid damage to the cooktop, do not use any cooking utensil that overhangs the surface element by more than one inch.

OPERATING THE COOKTOP

SETTING THE SURFACE CONTROLS

To Use

Push In and Turn the control to the desired setting. The surface unit indicator will light.

When finished

Turn all controls to "Off". The surface unit indicator lights will turn off.

COOKING ON THE SURFACE OF YOUR RANGE

Cooking on the surface of your electric range is done by conduction. When the unit is turned on, an electric current heats the element. The element will heat the pan when they are in proper contact. Your range is equipped with reflector pans. The element rests on the reflector pan. The reflector pan reflects heat to the bottom of your cooking utensil and catches spillovers.

The controls for the surface of the range are located on the backguard. You must Push In and Turn the controls. They can be adjusted in either direction. The illustration on the top right of each knob will show the burner it will operate.

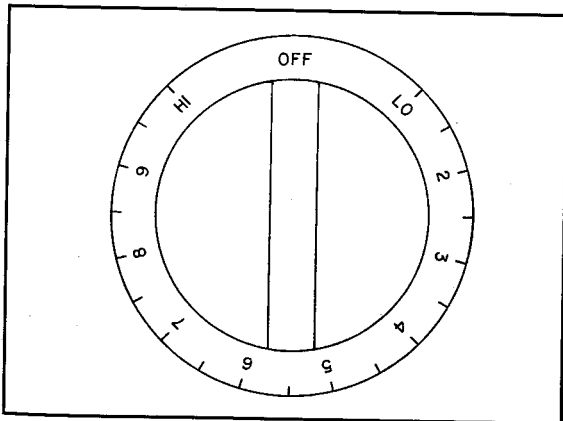

KNOB SETTINGS

Each dial can be set to any required cooking temperature. In addition, there are distinct "click" features for "HI", "LO", and "OFF". The element will cycle on and off to maintain the desired temperature. The temperature you select should be based on the amount of food and the type of utensil. The following guide will help you prepare the average family meal.

"LO" should be used for food that is prepared at less than boiling temperatures. It can also be used to keep food and beverages at serving temperatures.

"2" through "4" can be used to maintain boiling of larger amounts of food, low temperature frying and to maintain correct pressure in a pressure cooker.

"5" through "6" should be used to maintain boiling of larger amounts of food, low temperature frying and to maintain correct pressure in a pressure cooker.

"7" through "9" can be used to fry meat, poultry or to maintain deep-fat frying temperatures.

"HI" should be used to bring food to boiling temperatures.

If electric cooking is new to you, some of the processes will differ from those you experienced with a gas range. Heat up and cool down times for your elements will be different depending on the chosen setting. Remember the element will retain heat after it has been turned off. This heat can sometimes help finish cooking the food.

USING THE OVEN

OVEN SHELVES

Both oven racks may be used for conventional baking and roasting. They will pull to a "stop" position without tipping.

To Remove The Racks:

1. Pull the rack forward to the first "stop" position.
2. Raise the forward edge of the rack (as shown below) and pull it past the second "stop".

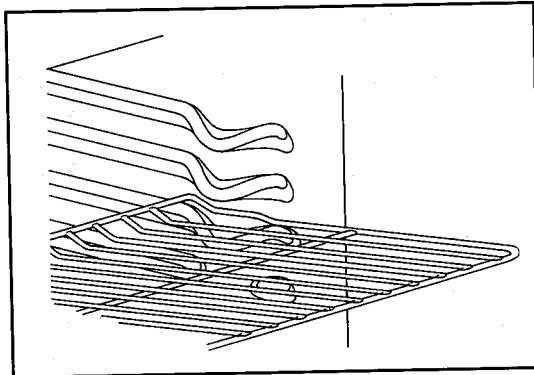

PAN PLACEMENT

When placing baking pans and cookie sheets in the oven, the pans should be kept a distance of two inches from the side and rear walls. If roasting or baking pans are placed on different shelves, they should be staggered so that one is not located directly under another. This will assure good distribution of heat and will allow food in both pans to be thoroughly cooked.

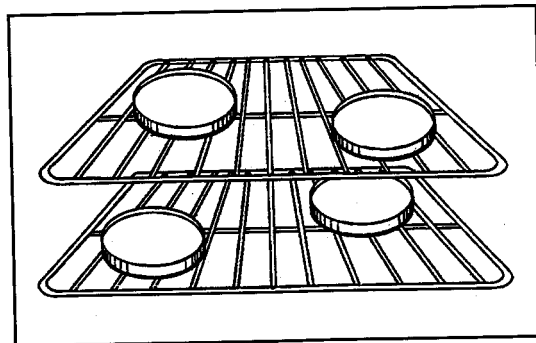

OVEN TIPS

- Use care when you open the oven door. Let any hot air or steam escape before removing or replacing food.
- Avoid frequent door openings. Use the oven light to view the food.
- For possible pie or casserole overflow, cut a piece of aluminum foil slightly larger than the utensil, and turn up the edges.

SHELF ARRANGEMENTS

The oven provides five different shelf positions. The shelves should be arranged before preparing foods or turning "ON" the oven. Refer to the section in this manual on BROILING to identify each shelf position.

⚠ IMPORTANT

To Avoid a Possible Fire: Never cover the oven racks, oven bottom, or oven elements with aluminum foil. Covering the oven racks will seriously affect baking results.

⚠ CAUTION

To reduce the risk of food poisoning due to bacterial growth and the production of toxins: never hold meat, poultry, milk, eggs, or fish products more than two hours.

- The safest foods to use are frozen casseroles and main dishes, or non-frozen soups or casseroles which do not contain meat, milk, eggs or fish.

SETTING THE CONTROLS

BAKING / ROASTING

TO USE

1. Press the Bake Temp button. **BAKE** and ___° will light in the display.
2. Turn the Temp. Set knob to adjust the temperature.
3. The oven will begin cooking in 3 seconds and **ON** will light in the display.

ture display will drop to 100°. As the oven heats the temperature will rise on the display until it reaches the set temperature. If you want to adjust the oven temperature while you are cooking, Press the Bake Temp button and adjust the temperature using the Temp Set knob.

WHEN FINISHED:

1. Press the Cancel button.

WHAT TO EXPECT:

When the oven begins to heat the tempera-

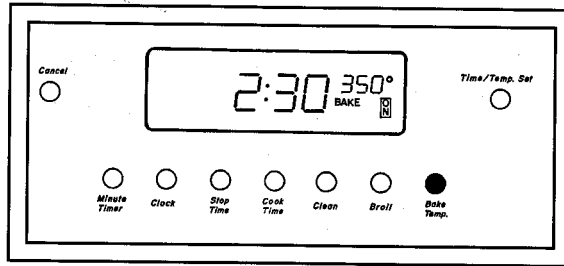

SETTING THE OVEN FOR DELAYED BAKING

1. Press the Cook Time button. **OVEN** and **TIME** will light in the display.
2. Turn the Time Set knob until the desired amount of cooking time is displayed.
3. Press the Stop Time button. **STOP TIME** and the earliest possible stopping time will light in the display.
4. Turn the Time Set knob to the time of day you want the oven to stop. **DELAY OVEN** will light in the display.
5. Press the Bake Temp button. **BAKE** will light in the display.
6. Turn the Temp Set knob to adjust the oven temperature. The temperature can be adjusted from 170° to 550°F.
7. The oven will begin cooking at the pre-set time and **ON** will light in the display.
8. When the cycle is complete the oven will "beep" until you Press **Cancel**.

stopping time. The oven will begin at the pre-determined time. **DELAY** will disappear from the display and **ON** will light in the display. The temperature display will drop to 100° and begin to rise with the oven temperature. The oven will automatically stop cooking at the pre-set time. When the oven is finished cooking it will continue to "beep" until you press the Set/Cancel button.

NOTE: You can check any of the pre-set times by pressing the corresponding buttons. For example, to check the stop time Press the Stop Time button.

WHAT TO EXPECT:

The control will automatically calculate the starting time based on the cooking and

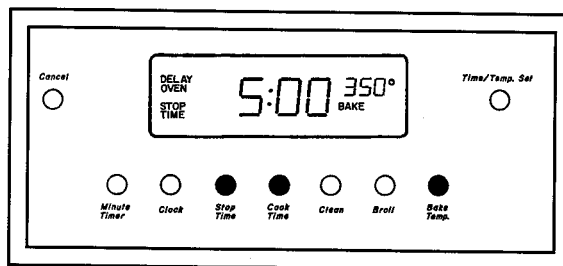

OVEN BAKING GUIDE

Hot Oven 400° - 500°F • Moderate Oven 350° - 375° • Slow Oven 300° - 350°F

Follow this guide for time and temperature unless they are given in the recipe you are using. Baking time will vary with temperature of ingredients and size and type of utensil being used. However, if the oven temperature is correct, the time should not vary more than that given in the guide.

BAKING TEMPERATURE/TIME

FOOD	DEGREES	MINUTES
YEAST BREADS		
Bread	400°	45-60
Rolls	375°	25-30
QUICK BREADS		
Baking Powder Biscuits	450°	12-15
Muffins	425°	20-25
Popovers	375°	45-60
Popovers with oven meal	350°	60-75
Nut Bread	400°	50-60
Corn Bread	375°-400°	30
COOKIES		
Drop	350°-375°	20-25
Rolled	375°-400°	8-12
Sliced	375°-400°	8-12
Brownies	350°	25-30
PIES		
Pie Shells	475°	10-15
Custard	400°	35-40
Pumpkin	475°	10-15
Apple	400°	45-60
Berry	425°	45-60
Mince	425°	35-40
CAKES		
8" Layer	375°	25-30
9" Layer	350°	30-35
Cup Cakes	375°	20-25
Loaf Cakes	350°	45-60
Angel Food	350°	40-50
Sponge	350°	40-50
Jelly Roll	425°	12-15
Fruit	250°-275°	2-4 Hrs.
Gingerbread	350°	30-50

CONVENTIONAL ROASTING

For best results, a shallow pan close to the size of the meat is recommended. The broiler pan can be used if necessary.

Place the meat on a rack or grid with the fatty side up. Do not cover or add water.

Place the pan on the oven rack with the center of the meat in the center of the oven.

Set the Oven Control to the desired temperature. Refer to the Roast Guide in this section.

USEFUL INFORMATION

When roasting frozen meats, allow 1/3 to 1/2 more cooking time than for roasts already thawed.

After cooking is complete, allow the roast to stand 15 to 20 minutes before carving.

Rare or medium rare meats can be removed slightly before they are ready; they will continue to cook while the roast is standing to be carved.

Meats and poultry prepared in the dry "roasted" method should not be covered; nor should water be added prior to roasting.

ROAST GUIDE

(An aid for roasting times and temperatures)

FOOD	OVEN TEMP.	MIN./ LBS.
BEEF		
• Roasts	325°	
rare		20-25
medium		26-30
well done		33-35
• Rolled Roasts	325°	
rare		32-36
medium		36-40
well done		43-45
PORK (fresh)		
Fresh Ham (whole)	325°	22-28
Loin		35-40
Shoulder, Butt		40-45
Shoulder, Picnic		35-40
HAM (smoked mild cure) ...350°		
Picnic Shoulder		30-35
FOOD	OVEN TEMP.	APPROX. COOK TIME IN HRS.
CHICKEN*		
4 to 5 lbs.	375°	1-1/2 to 1-3/4
over 5 lbs.		1-3/4 to 2
TURKEY**		
6-8 lbs.	325°	3-1/2 to 4
8-12 lbs.		4 to 4-1/2
12-16 lbs.		5-1/2
20-22 lbs.		7 to 8-1/2
DUCK		
3-5 lbs.	325°	1-1/2 to 2
GOOSE		
6-8 lbs.	325°	3 to 3-1/2

* Small chickens can also be roasted at 400° for darker browning. If so, the cooking time should be shortened.

** For stuffed turkey or duck, cooking time may increase 15 to 20 minutes.

KEEPING FOOD WARM

The Keep-Warm oven can be helpful in many ways.

If you wish to keep the food warm immediately after baking at a higher temperature, set the oven to the correct temperature (see chart) and open the oven door for 10 to 15 minutes to allow excess heat to escape.

NOTE: If you plan to keep food warm on a platter, be sure the oven has cooled after baking before placing the platters in the oven.

TO AVOID THE RISK OF FIRE, DO NOT USE PLASTIC PLATTERS, OR SILVER TRAYS IN THE KEEP-WARM OVEN.

To prevent moist foods such as cooked vegetables, mashed potatoes, gravy, yeast rolls, biscuits, etc., from drying out, they should be covered tightly before being placed in the oven. Aluminum foil is ideal for this.

Meat can be carved ahead of time and then kept warm. Sliced meats must be covered to prevent cut surfaces from drying. If you wish to slice rare or medium meats you can do so if you do not allow the cut surfaces to remain exposed to the air. Cut the slices as described but keep the surfaces close together.

THAWING FROZEN FOODS

The oven may be used for thawing frozen foods. Poultry should only be thawed until the giblets can be removed. Thaw cut-up poultry, fish or meat cuts just enough to separate the pieces. Ground meat should be thawed just enough to allow you to mix and form it. Once the food is thawed, cook it immediately. Do not refreeze food that has been thawed.

To thaw and freshen cooked frozen baked goods, use the Warm setting. Wrap food loosely to prevent drying but to permit the evaporation of ice crystals formed during freezing.

KEEP-WARM OVEN CHART

BACON	225°
BEEF	
Rare	170°
Medium	170°
Well Done	170°
FISH	
Baked or Broiled (loosely covered)	170°
HAM	170°
LAMB	170°
PORK	
Fresh	170°
Smoked	170°
POULTRY	
Roasted	170°
Fried	170°
SEAFOOD	
Baked or Fried (loosely covered) ...	170°
VEGETABLES	
(covered)	170°
BISCUITS/MUFFINS	170°
CASSEROLES	200°
GRAVY	170°
PIZZA	
(loosely covered)	225°
ROLLS	
(tightly wrapped)	170°
DEEP FAT FRIED FOOD	200°
POTATOES	
Baked	200°
potatoes	170°
(loosely covered)	250°
PIES/PASTRY	170°

BAKING PROBLEMS, REASONS WHY, WHAT TO DO:

PROBLEM	REASON WHY	WHAT TO DO
Cookies, biscuits, burn on bottom	Oven preheat time too short.	Allow oven to preheat to desired temperature.
	Oven shelf overcrowded.	Select pan sizes that leave air-space on all sides of pan.
	Pan heats too fast.	Use light colored baking sheets.
Bread does not rise in oven.	Oven is too hot.	Reduced temperature or recheck oven setting.
Bread loaf bakes over pan, poorly shaped.	Oven temperature too low.	Recheck oven temperature
Cakes not baked in center.	Oven too hot.	Set oven temperature 25 degrees lower, and bake recommended time.
	Type and size of pan.	Use suggested pan size, glass baking dishes usually bake at a lower temperature.
Cakes fell.	Underbaked, oven door opened too often.	Keep oven door closed. Bake recommended time.
Cakes not level.	Range or oven shelf not level	Place a marked glass measuring cup, filled to one marking with water, in center of oven rack. If water level is uneven, refer to installation instructions for leveling range.
	Pan too close to oven wall.	Allow minimum of 1-1/2 inches clearance on all sides.
Foods undercooked after recommended cooking time has elapsed.	Oven not up to temperature.	Set oven temperature 25 degrees higher and bake recommended time.
	Improper use of foil.	Foil should not be placed on floor of oven, over a cooking shelf or thermostat bulb.

USING THE BROILER

The broiler uses infra-red rays that travel in straight lines. These rays will sear the outside of the food while locking in all the flavor and juices. The cooking area of the broiler will get smaller as the food is moved closer to the element. In high rack positions, the rays will not reach the corners of the broiler grid. If you have never used an "Infra-Red" broiler follow this rule of thumb:

Outside Charred and Inside Rare..... High Rack position and short time
Outside Charred and inside Well Done Lower Rack position and more time

SPECIFICS

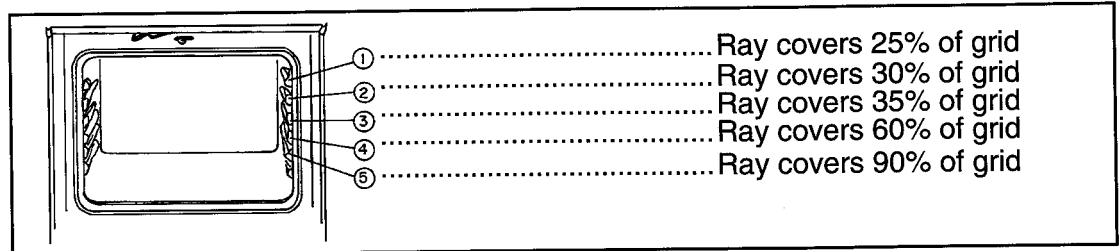

The door may be open or closed during broiling.

BROILING TIPS

1. The best foods to broil include steaks, hamburgers, chicken, fish, pork or lamb chops and vegetables.
2. Remove excess fat from the meat and slash the edges to prevent them from curling.
3. Do not pierce meats before or after broiling. If the meat has been pierced it may lose some juices.
4. Season the meat after it has browned. Uncooked meat that is seasoned may become tough.
5. Broiled food, EXCEPT FOR FISH, should be turned at least once.
6. Fish should be broiled with the skin side down.
7. Broil hamburgers on shelf position 4.

NOTE: The broiler does not need to be preheated before using.

! WARNING

Do not line the broiler pan with foil. Foil will not allow grease and liquids to drain from the food causing smoking or fire.

BROILER PAN POSITION

Position broiler pan with short sides parallel to the back of the oven so that it is directly lined up under the broiler.

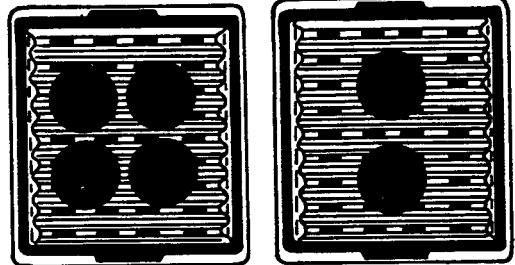

BROILING

TO USE THE BROILER

TO BROIL:

1. Push the Broil button. BROIL and _____ will appear in the display.
2. Turn the Temp Set knob to adjust the broil temperature from "1" to "HI".
3. BROIL and ON will remain in the display.

WHEN FINISHED:

1. Push the Cancel button.

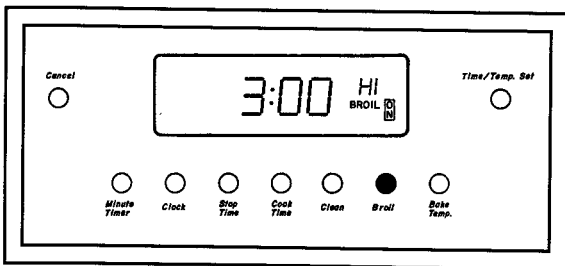

CHOOSING A BROIL SETTING

Your range has six variable broil settings. These settings range from "1", to "HI". The variety of settings were designed to allow you the freedom of controlling the oven temperature during broiling.

When using the variable broil feature follow these general rules:

- Red meats are best cooked on "HI"
- Pork is best Cooked on "5"
- Chicken is best cooked on "4"
- Fish is best cooked on "3"
- Fruit or Vegetables are best on "3"
- Breads are best toasted on "1"

NOTE: Choosing a broil setting will depend on the type of food you plan to cook and the temperature of the food before cooking.

BROILING CHART

FOOD	BROILING TIME (MIN.)	FOOD	BROILING TIME (MIN.)
BEEF (use rack position 2)		FISH (use rack position 2)	
Steaks (1" thick)		Fillets or Steaks	10
Rare	10	LAMB (use rack position 2)	
Medium Rare	11	Chops or Steaks	
Medium	12-14	1" thick	8-10
Well Done	20	1-1/2" thick	12-14
Steaks (1-1/2" thick)		2" thick	14-16
Rare	15	PORK (cured) (use rack position 2)	
Medium	20-25	Bacon	2-6
Well Done	30	Ham Slice (cook before eating)	
Ground Beef Patties		1/2" thick	19-20
(3/4" to 1" thick)	8-15	1" thick	20-30
CHICKEN (use rack position 3)		Ham Slice (fully cooked)	
Breast (split with ribs)	20-25	1/2" thick	10-15
Breast (boneless)	13-17	1" thick	15-20
BREADS (use rack position 1)			
Broil Until Toasted			

SELF CLEANING THE OVEN

STEPS TO FOLLOW BEFORE SELF CLEANING

1. Remove all containers, spoon holders, spices and etc., from the range top.
2. Remove all pots, pans and oven racks from inside the oven. These things will become too hot during the cleaning cycle causing them to warp.
3. Wipe up the excess spills from the oven interior.
4. Remove soil from the oven frame, side of door and door liner.

TIPS ON SELF CLEANING

- A small amount of smoke is normal, excessive smoke may indicate that there is a faulty gasket or too much food has been left in the bottom of the oven.
- The oven should always be cleaned before it gets too dirty. If you cannot clean your oven in one cycle, repeat the cleaning cycle.
- Never use a chemical oven cleaner. Some chemicals may have a reaction in the oven interior at high temperatures.

! WARNING

Do not clean the oven door gasket. The gasket can be damaged as a result of rubbing or moving.

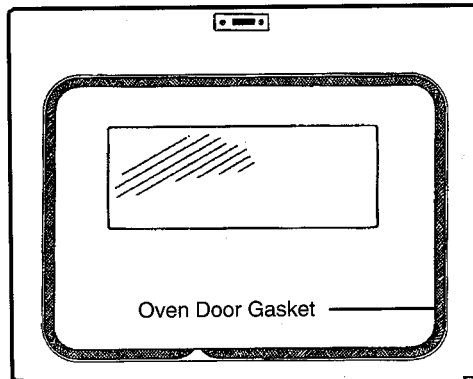

! WARNING

To reduce the risk of severe burns, do not obstruct or touch areas near the vents or range surface. These areas become hot during the cleaning cycle.

SUGGESTED SELF CLEANING TIMES

LIGHT TO MODERATE SOIL	2 HOURS
HEAVY SOIL	3-4 HOURS

SELF CLEANING THE OVEN

SETTING THE SELF-CLEANING CYCLE

TO CLEAN:

1. Remove everything from inside the oven, and lock the door lock lever as shown above. LOCK will light in the display.
2. Push the Clean button. CLEAN will light in the display.
3. Turn the Time Set knob to the desired cleaning time. Clean can be set from 2 to 4 hours.
4. The oven will automatically begin to clean in 3 seconds and ON will light in the display.

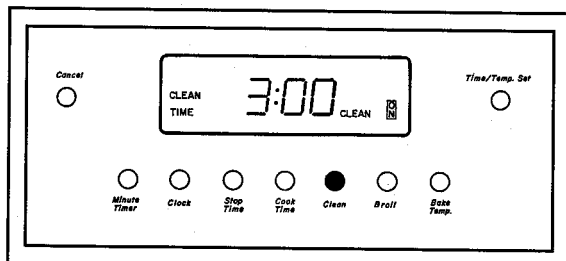
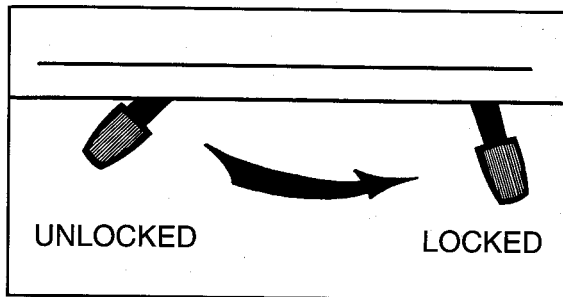

! WARNING

Do not store items on the range top. During cooking or cleaning these items may become too hot.

SETTING THE SELF-CLEANING CYCLE TO START AND STOP AUTOMATICALLY

1. Remove everything from the oven and lock the door lock lever as shown above. LOCK will light in the display.
2. Push the Clean button. CLEAN will light in the display.
3. Turn the Time Set knob to the desired cleaning time. Clean can be set from 2 to 4 hours.
4. Push the Stop Time button. The earliest possible stopping time will appear in the display.
5. Turn the Time Set knob to adjust the stopping time.
6. The control will automatically compute a starting time based on the clean and stop time you entered. DELAY CLEAN STOP TIME and LOCK will appear in the display.
7. When the oven begins, CLEAN and ON will appear in the display.

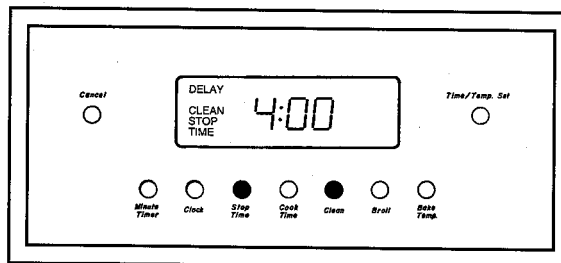

NOTE If the door is not locked "DOOR" will appear in the display.

SELF CLEANING THE OVEN

WHAT TO EXPECT DURING SELF CLEANING

- The oven and the clean indicator lights will be on until the cleaning cycle is finished.
- The first few times the self cleaning cycle is used, there may be some minor smoking and slight odor as the oven insulation "cures." This will disappear after the first few cleaning cycles.
- Vapor and warm air will pass through the oven vent. Do Not Obstruct the Air Flow.
- The outer surfaces of the range will become hot. Do Not Touch The Outer Areas Of The Range During Self Cleaning.

WARNING

Do not store or place any combustible materials, gasoline or other flammable liquids near your range.

TO INTERRUPT THE SELF CLEANING CYCLE

1. Press the Cancel button.
2. Do not attempt to open the door lock lever until the oven has cooled for at least 30 minutes.

NOTE Do not use the door lock lever when you are baking. Moving the lever to the right may cause the door to lock at normal bake temperatures. If you accidentally lock the door, turn off the oven and wait for it to cool before you attempt to move the lock lever and re-open the door.

CAUTION

Do not try to force the oven door open. This can damage the automatic door locking system.

CLEANING THE RANGE

PART	MATERIALS TO USE	GENERAL DIRECTIONS
Elements		Do not clean the bake element or broil element. Any soil will burn off when the element is heated. The bake element is hinged and can be lifted to clean the oven bottom.
Broiler Pan and Grid	Soap and a Nonabrasive Plastic Scouring Pad	Drain fat, cool pan and grid slightly. (Do not let soiled pan and grid stand in oven to cool.) Sprinkle with soap. Fill the pan with warm water. Let pan and grid stand for a few minutes. Wash: scour if necessary. Rinse and dry. Option: The broiler pan and grid may also be cleaned in a dishwasher.
Oven Control Knobs	Mild Soap and Water	Pull off knobs. Wash gently but do not soak. Dry and return controls to oven, making sure to match flat area on the knob to the flat area on the shaft.
Outside Finish and Backguard	Soap and Water	Wash all glass with cloth dampened in soapy water. Rinse and polish with a dry cloth. If knobs are removed, do not allow water to run down inside the surface of glass while cleaning.
Inside Oven Door	Soap and Water	Clean the outside of the door and the window area with warm soapy water. DO NOT clean the oven door gasket. The gasket should not be moved while cleaning. Avoid getting any cleaning materials on the gasket.
Oven Interior Surfaces	Soap and Water	Cool before cleaning. Frequent wiping with mild soap and water will prolong the time between major cleanings. Be sure to rinse thoroughly.
Oven Racks and Storage Drawer	Soap and Water	For heavy soil, clean by hand and rinse thoroughly. Remove the drawer and racks for ease in cleaning. Be sure the drawer is dry before replacing it.

To prevent the possibility of stains wipe up all spills immediately with a dry cloth. Acids will stain even the most stain resistant materials and finishes, so take extra care when you are cooking with vinegar, milk, lemon juice and sauces and tomatoes.

Hard To Clean Oven Racks: Sprinkle baking soda and vinegar on the racks and use a nonabrasive scrub pad to remove the soil. If the soil is not removed place the racks in a garbage bag with a cup of ammonia. Close the bag tightly and leave the racks for 24 hours. When you are ready to open the bag, make sure you have turned it away from your face because the odor will be strong. Rinse the racks with clean water.

CARE AND MAINTENANCE

REMOVABLE OVEN DOOR

The oven door is removable for convenience when cleaning. Do not immerse the oven door in water. DO NOT PLACE HANDS NEAR THE DOOR HINGES WHEN THE DOOR IS NOT IN PLACE.

TO REMOVE OVEN DOOR:

1. Open the door to the first stop position (approximately 5 inches).
2. Grasp the door firmly at each side and lift it upward and off the hinges.

! CAUTION

OVEN DOOR IS HEAVY.

TO REPLACE THE OVEN DOOR

1. Align the door with the hinge arms.
2. Slide the door down and into place. Be sure the door is all the way down on the hinges before closing, to prevent the possibility of chipping porcelain or scratching chrome.

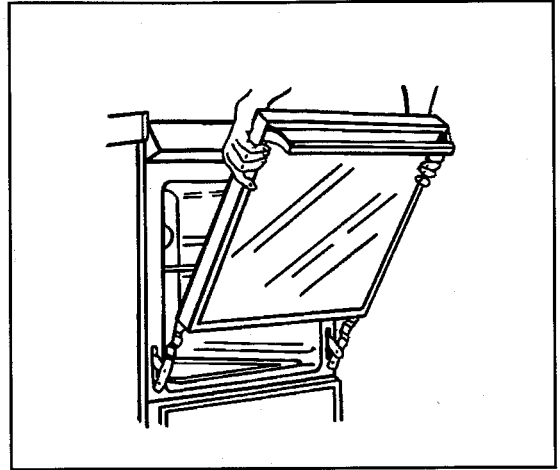

STORAGE DRAWER

The storage drawer is for storing pots and pans. The drawer can be removed to make it easier to clean under the range.

TO REMOVE THE STORAGE DRAWER

1. Pull the drawer straight out to the first stop. Lift the front and pull out to the second stop.
2. Let the front of the door rest on the floor. Place your hands toward the back of the drawer and lift it out.

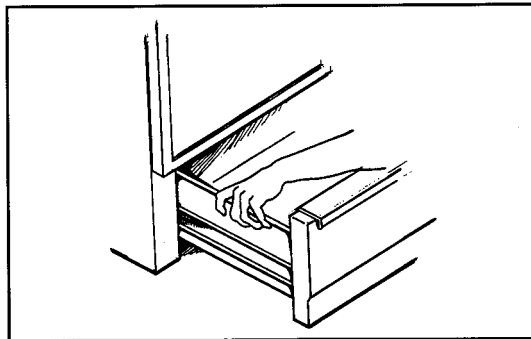

FIGURE 1

TO REPLACE THE STORAGE DRAWER

1. Place the set of rollers on the drawer behind the set of rollers on the oven. (As shown in figure 2)
2. Align the guides and push the drawer back into position.

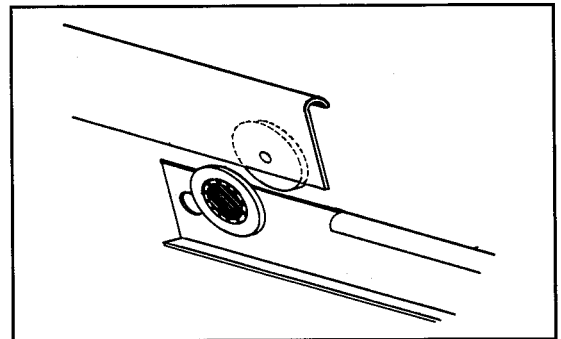

FIGURE 2

REPLACING THE OVEN LIGHT

! WARNING

Make sure the oven, light cover, and bulb are cool before you begin. Be sure the oven power is off. You can turn it off at the main fuse or circuit breaker.

! WARNING

You must replace the cover after changing the bulb. The cover protects the bulb from becoming too hot. Be careful not to drop the bulb or cover. They are made of glass and can cause severe injuries if broken.

STEPS TO CHANGE THE LIGHT:

1. Disconnect the oven power at the main circuit breaker.
2. Unscrew the glass cover counterclockwise.
3. Unscrew the light bulb counterclockwise.
4. Replace the bulb with a 40-watt appliance bulb.
5. Replace the bulb cover.
6. Reconnect the power to the oven.

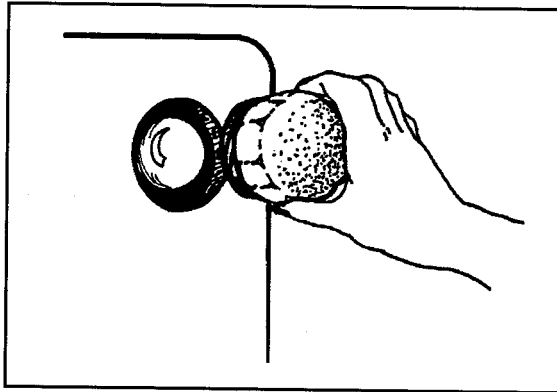

NOTE: Do Not Over Tighten The Bulb Cover. Replace the cover so it is secure but not tight. After repeated use of the oven, a cover that has been over tighten will be very difficult to remove.

COMMONLY ASKED QUESTIONS

Question: I've put an oven thermometer in my oven and noticed it does not maintain a constant temperature. Do I have a problem?

Answer: To maintain a temperature for baking, your oven will cycle off and on. You may see a "swing" in temperature of as much as $\pm 25^{\circ}\text{F}$. This temperature cycling is considered a normal procedure in range operation.

Question: Is it normal for my rangetop to get warm during use?

Answer: The porcelain rangetop may become warm to the touch while the range is being used to bake, broil or self clean. The longer the range is operated, the more the heat can be conducted to the rangetop.

Question: If my range clock is not working can I still self-clean my oven?

Answer: No. Your oven control uses the oven clock to help start and stop your self-clean cycle.

If the oven does not heat: Check to be sure the oven has been set to the correct temperature and/or that the oven is not set for a delayed bake function.

If the clean cycle does not start: Check to see that the oven timer is not set for a delayed start.

Question: Can I use the Timer during oven cooking?

Answer: The timer can be used during any cooking function and is especially handy when baking or broiling. The Timer can also be used while you are using the automatically timed functions.

Question: Should there be any odor during the cleaning cycle?

Answer: Yes. There may be a slight odor during the first few cleaning cycles. Failure to wipe out excessive soil may also cause an odor when cleaning.

Question: What should I do if excessive smoking occurs during cleaning?

Answer: This is caused by excessive soil, and you should press the CANCEL button to shut the oven off. Open windows to rid room of smoke. When the oven has cooled and the door unlocks, wipe up the excess soil and reset the cycle.

If the latch lever cannot be moved to an unlocked position: The oven must be cool to move latch lever to the left or to an unlocked position. If the latch does not unlock after the oven has cooled call your dealer or an authorized service agency.

DO NOT FORCE THE LATCH LEVER. IF THE LEVER IS FORCED OPEN, THE COSTLY SELF CLEAN MECHANISM WILL BE DAMAGED.

ADJUSTING THE OVEN TEMPERATURE

HOW TO ADJUST OVEN TEMPERATURE

The oven has been calibrated at the point of manufacture. However, if you wish to adjust the oven temperature to make it bake hotter or cooler, follow these steps.

To Adjust The Temperature:

1. Push the Bake Temp button once.
2. Turn the TIME/TEMP SET knob clockwise until an oven temperature greater than 500°F shows in the display.
3. Immediately push and hold the BAKE TEMP button until "00" appears in the display (approximately 5 seconds).
4. **To decrease the oven temperature (for cooler oven):** Turn the TIME/TEMP SET knob clockwise until the negative number (-05 through -35 in five degree increments) that represents the °F you wish to select appears. For example, if you want to decrease the oven temperature 20°F you select -20.
5. **To increase the oven temperature (for hotter oven):** Turn TIME/TEMP SET knob clockwise past the negative numbers until the positive numbers (05 through 35 in five degree increments) appear. Select the number which represents the °F you wish to increase the oven temperature. For example, if you want to increase the oven temperature 15°F you select 15.
6. Push SET/CANCEL button to enter this new oven temperature adjustment. Your oven bake and broil temperatures are now adjusted hotter or cooler as you have selected. This temperature adjustment is retained, even through power interruptions.

SERVICE TONES

If the oven control sounds a series of short, rapid beeps and the display shows a diagnostic service code (F0-F9) service tone for over 16 seconds, disconnect the service breaker and unplug the range. Next, contact your nearest authorized service person and indicate which diagnostic service code has appeared in your display. Each diagnostic service code indicates which part of the control or oven needs to be checked by the service person.

F0- indicates a problem with the CANCEL button operation.

F1 and F7- indicate a possible short in the control.

F3, F4, F5, and F8- The service tone will continue to occur when the oven is used for bake, broil or clean operations.

F6- the control will not sound a service tone when this code appears in the display.

F9- the door lock mechanism needs to be checked by a service person.

Fd- bake or broil elements need to be checked by a service person.

Note: If the electronic control should ever flash through different feature, you have probably programmed the sales-demo mode. Press the cancel button to clear the display.

BEFORE YOU CALL A SERVICE PERSON

Make sure you have followed the instructions in your Use and Care Manual. Avoid unnecessary service calls for difficulties that are not a result of defective workmanship or materials. If the problem is not caused by workmanship or materials, or if the component is customer replaceable, you will be charged for a service person's travel expenses and labor, even though the product may be under warranty. The following items are considered customer replaceable: oven racks, light bulbs, and control knobs which can be removed by pulling them off the control shaft. The heating elements in the rangetop can be replaced individually by an authorized service person.

WHEN SERVICE IS REQUIRED

The dealer from whom you purchased the range can give you the name of your nearest Authorized Service Center. Help them give you prompt service by giving them:

1. An accurate description of the trouble.
2. Complete model, serial, and manufacturing numbers located on the oven frame below the oven door.
3. Proof of purchase (sales receipt on request).

Repair by an unauthorized servicer that results in subsequent failure will void the warranty. Warranty details are contained in the warranty certificate enclosed with this booklet.

Keep an accurate record of any service calls: what was done, who serviced the range, and the date of service.

We have a vast network of Authorized Service Centers in the U.S., however, if you should have a service problem that is not resolved please **Write:**

**Consumer Affairs Department
Amana Refrigeration, Inc.
Amana, Iowa 52204**

For quicker service or for answers to questions concerning product usage, installation, and warranty, call:

**CONSUMER INFORMATION LINE
TOLL FREE 1-800-843-0304**

Asure[™]

EXTENDED SERVICE PLAN

Amana is pleased to offer an important opportunity for long-term service protection on your new Amana appliance. The Amana Asure Extended Service Plan is specially designed to supplement the strong warranty that already accompanies your appliance, and it combines with this standard warranty to provide budget protection coverage on your appliance for up to five full years, covering parts, labor and travel charges.

Your participating Amana dealer has details or you can call or write us using the number or address listed above.