

use & care guide

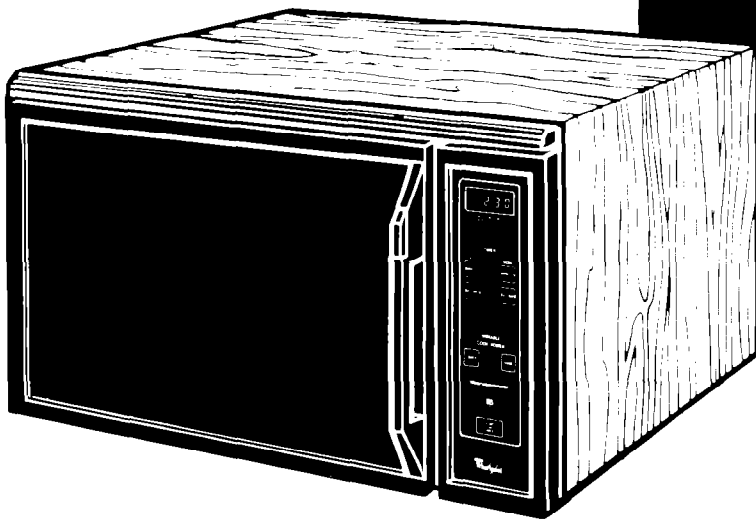
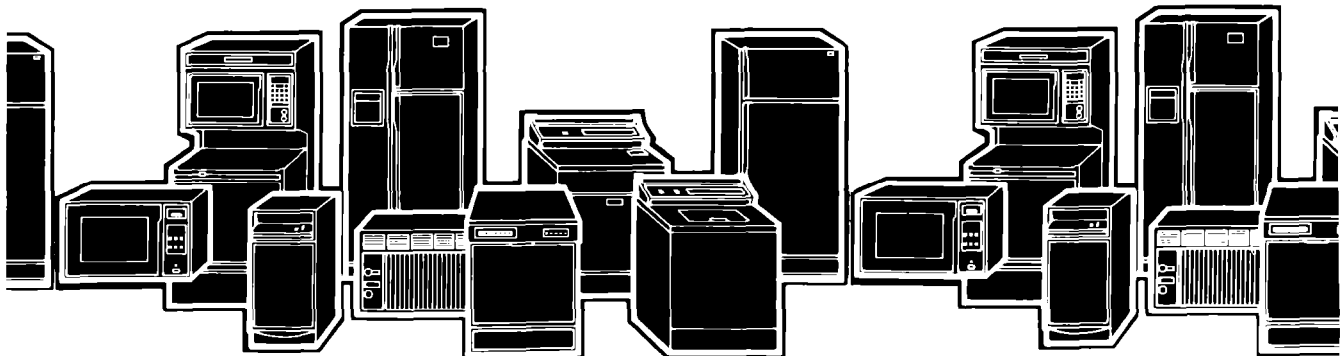

MICROWAVE OVEN

Model MW8500XS

ors. Ice Makers. Dishwashers. Built-In Ovens and Surface Units. Ranges. Microwave Ovens. Trash Compactors. Room Air Conditioners. Dehumidifiers. Automatic Washers. Clothes Dryers. Freezers. Re



Contents

	Page		Page
Parts and Features	2	Bi-Level Cooking	7
Before You Install Your Microwave Oven	3	Installation Instructions	7
Before You Use Your Microwave Oven	3	Grounding Instructions	8
Precautions to Avoid Possible Exposure to Excessive Microwave Energy	3	Building In Your Microwave Oven	9
Important Safety Instructions	4	Caring For Your Microwave Oven	9
Using Your Microwave Oven	5	Cleaning the Microwave Oven	9
Microwave Oven Controls	5	Replacing the Light Bulb	9
Cooking in Your Microwave Oven	5	How Your Microwave Oven Works	10
Setting the Controls	6	Operating Safety Precautions	11
		If You Need Service or Assistance	13
		Microwave Oven Warranty	16

©1987 Whirlpool Corporation

Parts and features

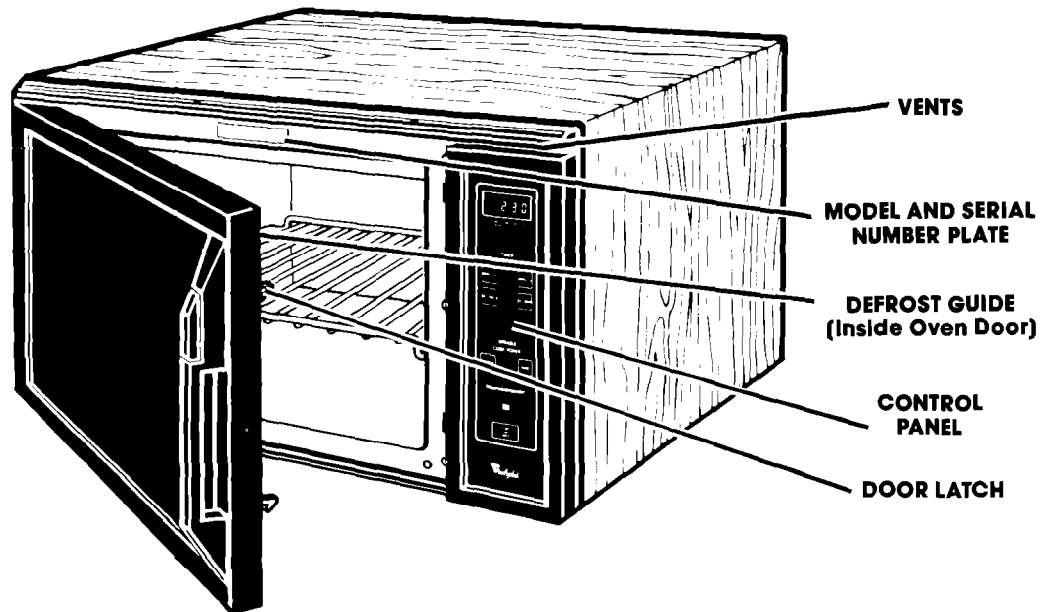

Copy your Model and Serial Numbers here...

If you need service or call with a question, have this information ready:

1. **Complete** Model and Serial Numbers (from the plate just behind the microwave oven door on the oven frame).
2. Purchase date from sales slip.

Copy this information in these spaces. Keep this book and your sales slip together in a handy place. **Please complete and mail the Owner Registration Card furnished with this product.**

Model Number _____

Serial Number _____

Purchase Date _____

Service Company Phone Number _____

Fill out and return the "Microwave Registration Card" included with your oven. If the card is missing, please send the model number of your microwave oven with your name and address to...

Whirlpool Corporation
Microwave Registration Department
Administrative Center
2000 M-63
Benton Harbor, Michigan 49022

This information will help us reach you if there is ever a need to pass along information about your microwave oven.

Before you install your microwave oven

Read and carefully follow the "INSTALLATION INSTRUCTIONS" found on page 7 of this "Use & Care Guide."

Before you use your microwave oven

Read this "Use & Care Guide" carefully for important use and safety information. Store in a convenient place for future use.



It is your personal responsibility and obligation to be sure your microwave oven:

- Has been installed where it is protected from the elements. **The microwave oven should be at a temperature above 50°F (10°C) for proper operation.**
- Has been installed on a surface strong enough to support its weight.
- Has been properly connected to electrical supply and grounded. (See "Installation Instructions.")
- Is not used by children or anyone unable to operate it properly.
- Is properly maintained.
- Is used only for jobs expected of a home microwave oven.

PRECAUTIONS TO AVOID POSSIBLE EXPOSURE TO EXCESSIVE MICROWAVE ENERGY...

DO NOT attempt to operate this oven with the door open since open-door operation can result in harmful exposure to microwave energy. It is important not to defeat or tamper with the safety interlocks.

DO NOT place any object between the oven front face and the door or allow soil or cleaner residue to accumulate on sealing surfaces.

DO NOT operate the oven if it is damaged. It is particularly important that the oven door close properly and that there is no damage to the:

- (1) Door (bent),
- (2) Hinges and latches (broken or loosened),
- (3) Door seals and sealing surfaces

DO NOT operate the microwave oven if the door window is broken.

The microwave oven should be checked for microwave leakage by qualified service personnel after a repair is made.

The oven should not be adjusted or repaired by anyone except properly qualified service personnel.

DO NOT operate the microwave oven with the outer cabinet removed.

IMPORTANT SAFETY INSTRUCTIONS

Microwave ovens have been used successfully in homes for a number of years. They are thoroughly tested for safe and efficient operation. However, as with any appliance, there are special installation and safety precautions which must be followed to ensure safe and satisfactory operation and prevent damage to the unit.



WARNING – To reduce the risk of burns, electric shock, fire, injury to persons or exposure to excessive microwave energy

1. Read all instructions before using appliance.
2. Read and follow the specific “**PRECAUTIONS TO AVOID POSSIBLE EXPOSURE TO EXCESSIVE MICROWAVE ENERGY**” found on page 3.
3. This appliance must be grounded. Connect only to properly grounded outlet. See “**GROUNDING INSTRUCTIONS**” found on page 8.
4. Install or locate this appliance only in accordance with the provided “**INSTALLATION INSTRUCTIONS**” found on page 7.
5. Some products such as whole eggs and sealed containers – for example, closed glass jars – may explode and should not be heated in this oven.
6. Use this appliance only for its intended use as described in this manual.
7. As with any appliance, close supervision is necessary when used by children.
8. Do not operate this appliance if it has a damaged cord or plug, if it is not working properly, or if it has been damaged or dropped. Electric shock, fire or other hazards may result.
9. This appliance should be serviced only by qualified service personnel. Call a Whirlpool authorized TECH-CARE® Service Company for examination, repair or adjustment.
10. Do not cover or block any opening on the appliance, for fire may result.
11. Do not use outdoors for damage to the oven or electric shock may result.
12. Do not immerse cord or plug in water for electric shock may result.
13. Keep cord away from heated surfaces for electric shock may result.
14. Do not let cord hang over edge of table or counter for electric shock may result.
15. See door surface cleaning instructions on page 9.
16. To reduce the risk of fire or fire in the oven cavity:
 - a. Do not overcook food. Carefully attend appliance if paper, plastic, or other combustible materials are placed inside the oven to facilitate cooking. Paper can char or burn, and some plastics can melt if used when heating foods.
 - b. Test dinnerware or cookware before using. See page 12. Some dishes (melamine, Centura,® etc.) absorb microwave energy, becoming too hot to handle and slowing cooking times. Remove wire twist-ties from paper or plastic bags before placing bag in oven. Cooking in metal containers can damage the oven. So can containers with hidden metal (twist-ties, foil lining, staples, metallic glaze or trim.)
 - c. If materials inside the oven should ignite, keep oven door closed, turn oven off, and disconnect the power cord, or shut off power at the fuse or circuit breaker panel.
17. Read and follow “**OPERATING SAFETY PRECAUTIONS**” starting on page 11.

SAVE THESE INSTRUCTIONS

Using your microwave oven

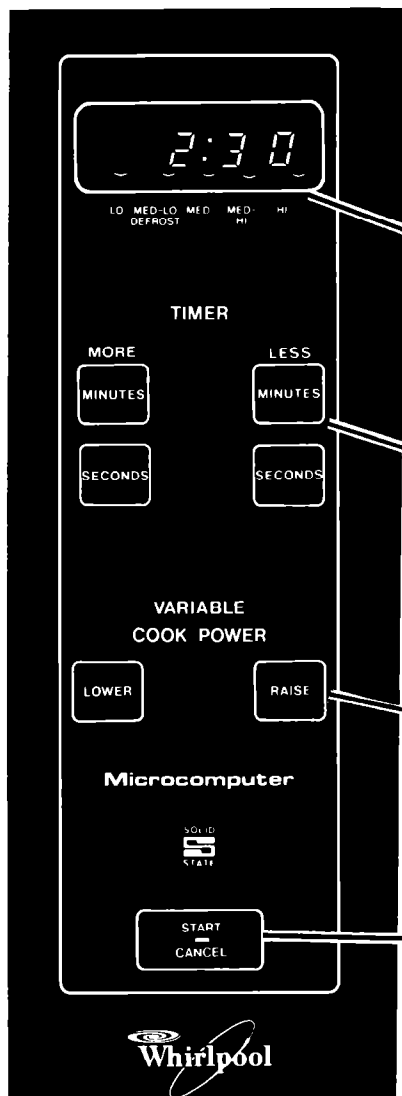

Microwave oven controls

There are four parts in the control section:

- The Digital Display and Indicator Lights
- The Timer Controls
- The Variable Cook Power Controls
- The Start/Cancel Pad

These will be covered on the following pages. Read them carefully.

The Digital Display and Indicator Lights

The Display will be blank when the oven is not in use. When you are using your microwave oven, this displays cooking time and Cook Power settings.

The Timer Controls

The Timer Controls allow you to select and set a desired cooking time by increasing and/or decreasing the time by pressing the appropriate pads. Both minutes and seconds can be adjusted separately. Cooking times can be set up to 59 minutes, 50 seconds.

The Variable Cook Power Controls

The Cook Power Controls allow you to choose the Cook Power setting that best meets your cooking needs. See the Cook Power Chart for different percentages of cooking powers.

The Start/Cancel Pad

The START/CANCEL Pad starts the cooking or stops the oven and cancels the settings. The oven door must be closed and latched before the oven will operate.

Cooking in your microwave oven

Be sure to read your **MICRO MENUS®** Cookbook furnished with your microwave oven. It contains information about:

- What microwave energy is
- How food is cooked by microwave energy
- What affects cooking speed and cooking evenness
- Safety tips
- Utensils to use when cooking in the microwave oven
- Cooking times for different foods

The MICRO MENUS® Cookbook will help you get the BEST COOKING RESULTS.

Important things to remember to get the BEST COOKING RESULTS.

- ALWAYS cook food for the minimum recommended cooking time. If necessary, add time in one or two minute periods, then check for doneness to avoid overcooking the food.
- Stir, turn or arrange the food being cooked about halfway through the cooking time for most even doneness with all recipes.
- If a glass cover is not available, use waxpaper, paper towels or microwave approved plastic wrap. Turn back a corner to vent steam during cooking.

Setting the controls

Be sure you understand the basics of microwave oven cooking before you start. Start with recipes from your MICRO MENUS® Cookbook. Follow the directions carefully.

DO THIS...

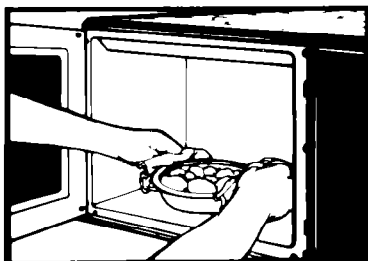

1. Place food in the oven, then close the door. **The oven won't work if the door isn't closed tightly.**

NOTE: The Display will be blank until a cooking time or Cook Power is set.



2. Press the MORE Minutes Pad until 1:00 shows on the Display. Continue to press or tap the pad until the Display shows the minutes of cooking time you want. To reduce the number of minutes on the Display, press or tap the LESS Minutes Pad until the proper number of minutes show on the Display.

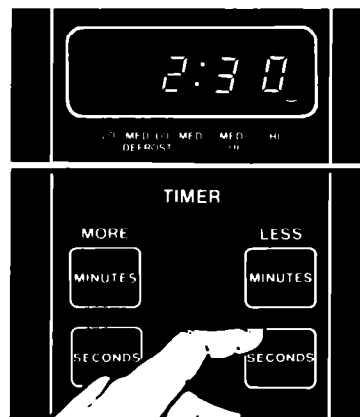

3. To set seconds, press the MORE Seconds pad until 10 seconds show on the Display. Continue to press or tap the pad to increase the seconds in 10 second increments up to 50. To reduce the number of seconds, press or tap the LESS Seconds pad to decrease the seconds in 10 second increments.

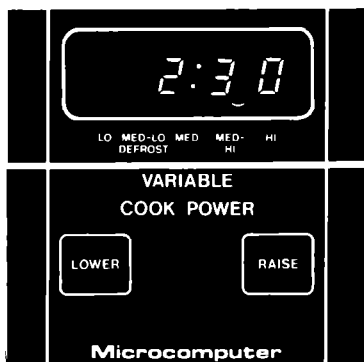

4. Set Cook Power to desired setting from HI to LO. **NOTE: The oven is set to cook at HI unless a lower power is selected.** Some recipes call for lower cook powers for best results. To select a lower setting, press or tap the LOWER pad. The indicator light on the Display will move to a lower setting. Press or tap RAISE to increase the power level from a lower setting.

COOK POWER CHART

Recipes in your MICRO MENUS® Cookbook use Cook power settings from HI to LO. Recipes from other books and magazines may use different Cook Power percentages. The following chart may be helpful:

HI – 100% of full power
MED-HI – 70% of full power
MED – 50% of full power
MED-LO/DEFROST – 30% of full power
LO – 10% of full power

5. Touch START/CANCEL. The oven light will come on and cooking will begin. The Display will count down in 1 second increments.



When the set time is up, "End" will show on the Display and 4 beeps will sound. "End" will remain on the Display until the door is opened. The Display will be blank until a new cooking time is set.

Time and cook power settings may be changed while the oven is operating. Touch the appropriate pad (Minutes, Seconds, Lower or Raise) until the desired setting shows in the Display. The oven will start cooking at the new time or cook power.

To stop the oven

Touch START/CANCEL or open the oven door. Opening the door stops the oven so you can stir, turn, rearrange or add ingredients to the food. Close the oven door and touch START/CANCEL to complete cooking. If you remove the food before the cooking time ends, touch START/CANCEL before closing the oven door. This cancels the remaining time.

Defrosting in your microwave oven

Use the MED-LO/DEFROST setting to thaw frozen food before cooking. This setting cooks at 30% of full power for desired defrosting time. For suggested defrost times, see chart inside the oven door.

Bi-level cooking

A removable Bi-Level Cooking Rack is available as an accessory kit. This rack lets you cook or reheat foods together as a meal. Ask your dealer for details on...

- 832985 – Bi-Level Cooking Rack Kit

Installation instructions

BEFORE YOU BEGIN, READ THE FOLLOWING INSTRUCTIONS COMPLETELY AND CAREFULLY.

Installing your microwave oven

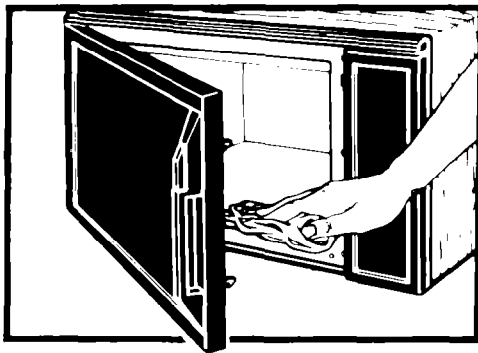

1. Empty the microwave oven and clean inside it with a soft, damp cloth. Check for damage such as misaligned door, damage around the door or dents inside the oven or on the exterior. If there is any damage, **do not** operate the unit until it has been checked by an authorized trained service technician and any repair made.

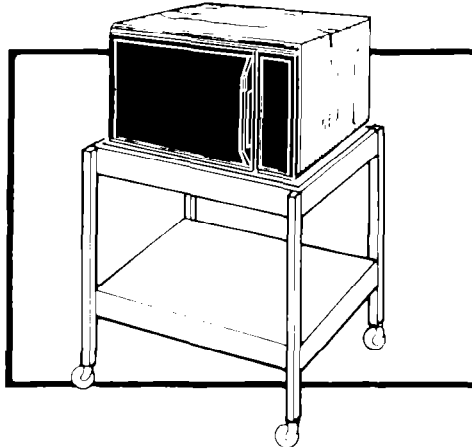

2. Put the oven on a cart, counter, table or shelf that is strong enough to hold the oven, the food and the utensils you put in it. **(The control side of the unit is the heavy side. Use care when handling.)** The weight of the oven is approximately 60 lbs. (27 kg)

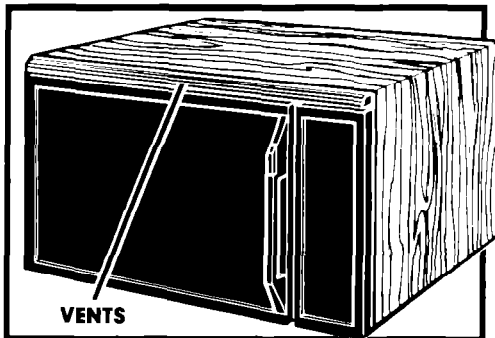

3. Do not block the vent opening at the front of the oven or the air intake opening on the bottom of the oven. Blocking vent or air intake openings can cause poor cooking results.

Make sure the microwave oven legs are in place. Do not set the oven on anything that will block the air intake openings.

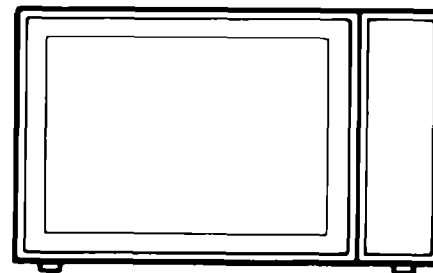

4. Do not install the oven next to a conventional surface unit or in any area where excessive heat and steam are generated. This could damage the outside of the cabinet.

continued on next page

5. Electrical requirements

Observe all governing codes and ordinances.

A 120 Volt, 60 Hz., AC only, 15 or 20 amp fused electrical supply is required. (Time-delay fuse is recommended.) It is recommended that a separate circuit serving only this appliance be provided.

6. GROUNDING INSTRUCTIONS

WARNING: Improper use of the grounding plug can result in a risk of electrical shock.

DO NOT, UNDER ANY CIRCUMSTANCES, REMOVE THE POWER SUPPLY CORD GROUNDING PRONG.

7. For your personal safety, this appliance must be grounded. In the event of an electrical short circuit, grounding reduces the risk of electric shock by providing an escape wire for the electric current. This appliance is equipped with a

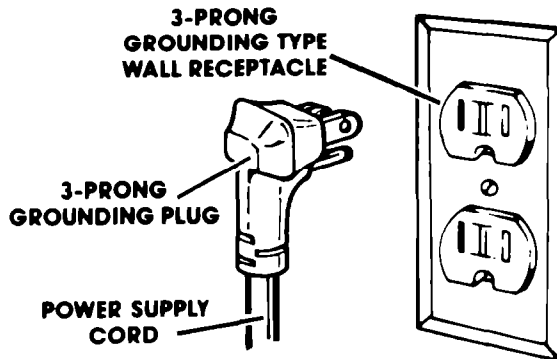

polarized 3-prong grounding plug. It must be plugged into a correct polarized mating 3-prong grounding type wall receptacle, properly installed and grounded in accordance with the National Electrical Code and local codes and ordinances. If a mating wall receptacle is not available or if you are not sure if the

wall receptacle is properly grounded and polarized, have it checked by a qualified electrician.

It is the personal responsibility and obligation of the customer to have a properly grounded and correctly polarized 3-prong wall receptacle installed by a qualified electrician.

Consult a qualified electrician if the grounding instructions are not completely understood, or if doubt exists as to whether the appliance is properly grounded.

It is NOT recommended to use an extension cord with your microwave oven, but if you find it necessary to do so temporarily (until a properly grounded and polarized 3-prong receptacle is installed), use only a heavy duty UL listed 3-wire grounding type extension cord containing three 16-gauge (minimum) copper wires. It must not be longer than 10 feet (cords longer than 10 feet may affect the cooking performance of your microwave oven). The plug on the extension cord must fit into a 3-prong grounding type wall receptacle (as shown on this page) and the receptacle end of the extension cord must accept the 3-prong grounding plug of the microwave oven.



8. To test the oven, plug it into the proper electrical outlet. **(NOTE: The Display will show 88:88 for three seconds after the oven is plugged in. The Display will then go blank until a cooking time or Cook Power is set.)** Put about one cup (250 mL) of cold water in a glass container in the oven. Close the door. Make sure it latches. Follow the directions on page 6 to set the oven to COOK for 1½ minutes. When the timer is up, the water should be warm.

9. This microwave oven is designed for use in the household only and must not be used for commercial purposes.

DO NOT remove the outer case, door, or control panel at any time. The unit is equipped with high voltage and should not be serviced unless by an authorized Whirlpool trained service technician.

SAVE THESE INSTRUCTIONS

Building in your microwave oven

Your microwave oven is not limited to carts, counters or tables. Custom installations are made easy with kits available from your dealer.

1. Build the microwave oven into a cabinet or wall by itself or over built-in single ovens in the Whirlpool RDE, REE, RGE, RB and SB model series.
2. Attach the microwave oven to a wall by itself or with cabinets over it.
3. Put the microwave oven on the **MICRO SHELF[®]** Hood over a cooktop. The hood is available ducted or as a recirculating hood, and includes cooktop lights.

Ask your dealer for details on...

- 832987 – 30-inch Built-in Kit
- 832989 – 24-inch Built-in Kit
- 832991 – 27-inch Built-in Kit
- 832993 – Wall Mounting Kit
- RH3330XR – MICRO SHELF[®] Hood

Use only approved installation kits. Obtain these kits from your authorized Whirlpool dealer.

Caring for your microwave oven

Cleaning the microwave oven



Wipe often with warm sudsy water and a soft cloth or sponge

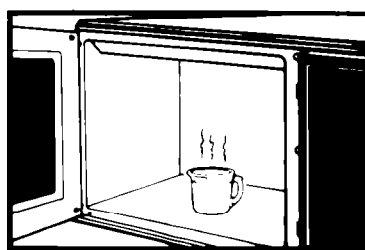

For stubborn soil, boil a cup of water in the oven for 2 or 3 minutes. Steam will soften the soil

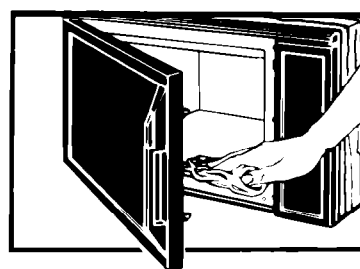

Be sure to clean the areas where the door and oven frame touch when closed. When cleaning surfaces of door and oven that come together on closing the door, use only mild, non-abrasive soaps or detergents applied with a sponge or soft cloth. Rinse well.

CAUTION:

Abrasive cleansers, steel wool pads, gritty wash cloths, etc., can damage the control panel, and the interior and exterior oven surfaces. Use a soft cloth or a sponge with a mild detergent or spray glass cleaner.

Replacing the light bulb

The microwave oven light should come on whenever the door is opened or the oven is operating.

To replace:

1. Unplug, or turn off at fuse box or circuit breaker.
2. Open the oven door.
3. Remove the 3 screws from the front of the cover.
4. Pull down the front portion of the cover. (It is creased across its width to form a hinge.)
5. Remove and replace the 25-watt candelabra-base bulb (Part No. 313969). Obtain bulb from your authorized Whirlpool dealer.
6. Close the cover and replace the screws.
7. Plug in, or turn on the main power supply.

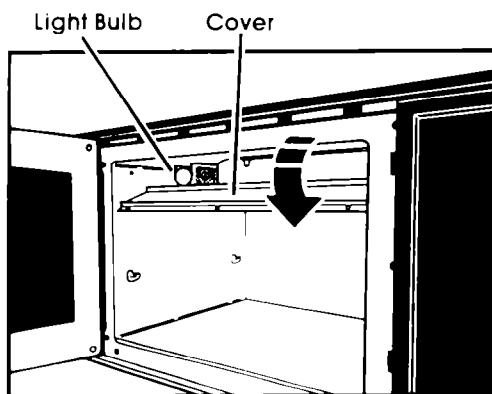

How your microwave oven works

Microwave ovens are safe. Microwave energy is not hot. It causes food to make its own heat, and it's this heat that cooks the food.

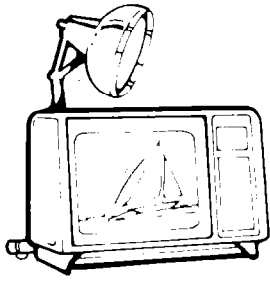

Microwaves are like TV waves or light waves. You can't see them, but you can see what they do.

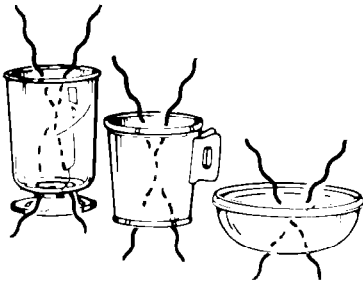

Microwaves pass through glass, paper and plastic without heating them so food absorbs the energy. Microwaves bounce off metal pans so food does not absorb the energy.

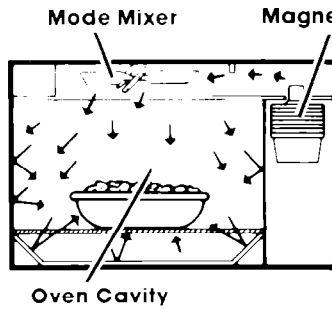

A magnetron in the microwave oven produces microwaves. The microwaves move into the oven where they are scattered or stirred by a mode mixer (like a fan). Microwaves bounce off metal oven walls and are absorbed by food.

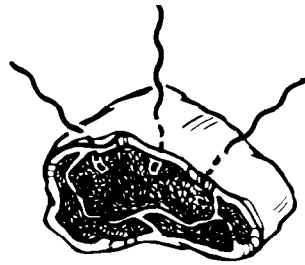

Microwaves may not reach the center of a roast. The heat around the outside is what cooks the roast all the way through. This is one of the reasons for letting some foods (roasts, baked potatoes) stand for a while after cooking, or for stirring some foods during the cooking time.

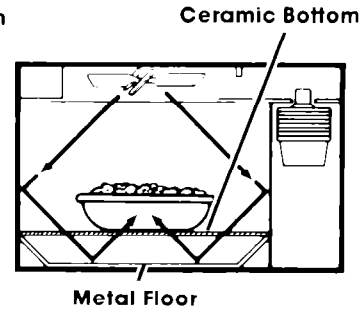

The ceramic bottom of your microwave oven lets microwaves through. Then they bounce off a metal floor, back through the ceramic bottom and are absorbed by the food.



The microwaves disturb water molecules in the food. As the molecules bounce around bumping into each other, heat is made, like rubbing your hands together. This is the heat that cooks.

Operating safety precautions



WARNING: DO NOT use oven until you have read and understand **ALL** the information on safe use.

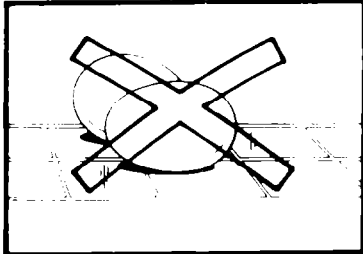

NEVER COOK OR REHEAT A WHOLE EGG.

Steam build-up in whole eggs may cause them to burst and burn you, and possibly damage the oven. Slice hard boiled eggs before heating. In rare instances, poached eggs have been known to explode. Cover poached eggs and allow a standing time of one minute before cutting into them.

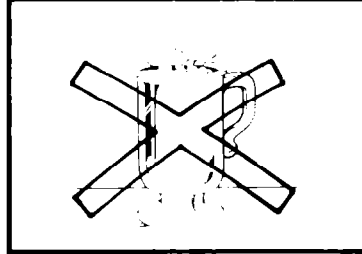

Liquids heated in certain containers (especially cylindrical-shaped containers) may become overheated. The liquid may splash out with a loud noise during or after heating or when adding ingredients (coffee, etc.) resulting in harm to the oven and possible personal injury. For best results stir any liquid several times before heating or reheating.

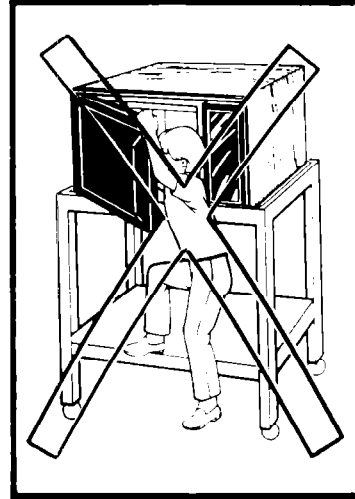

NEVER lean on the door or allow a child to swing on it when the door is open. Injury could result.

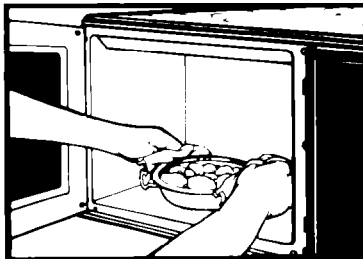

USE HOT PADS. Microwave energy does not heat containers, but the hot food does.

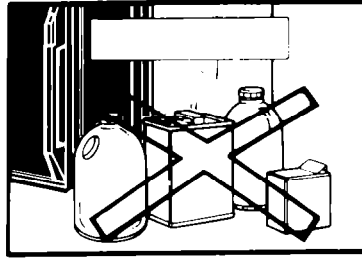

DO NOT heat, store or use flammable or inflammable materials in or near the oven.

DO NOT can foods in the oven. Closed glass jars may explode resulting in damage to the oven or possible personal injury.

DO NOT use the oven to sterilize objects (baby bottles, etc.). It is difficult to maintain the high temperature required for safe sterilization.

continued on next page

CAUTION: DO NOT use the oven until you have read and understand **ALL** precautions to prevent damage to the oven.

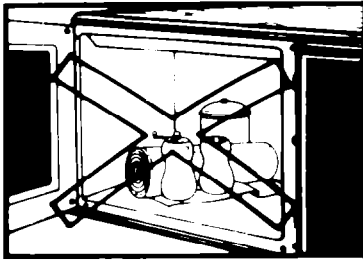

DO NOT use the oven for storage. Do not leave paper products, books or cooking utensils in the oven when not in use. Fire may result if someone accidentally starts the oven. Don't let anything touch the top of the oven.

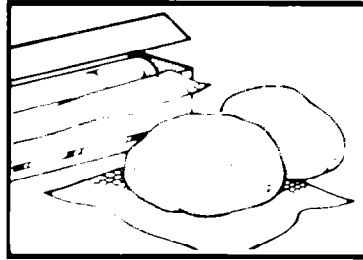

DO NOT OVERCOOK POTATOES. Fire could result. At the end of the recommended cooking time they should be slightly firm. Wrap in foil and set aside for 5 minutes. They will finish cooking while standing.

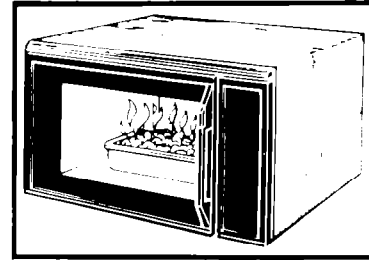

If a fire should start in the oven cavity:

- **keep door closed**
- **turn oven off**
- **disconnect the power supply** at the cord, fuse box or circuit breaker.

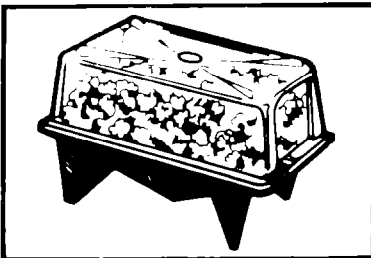

DO NOT pop popcorn, except in a microwave-approved popcorn popper or commercial package designed especially for microwave ovens. Results are the manufacturer's responsibility. **NEVER** try to pop corn in a paper bag. Overcooking may result in smoke and fire.

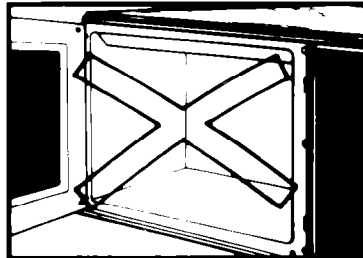

Starting a microwave oven when it's empty is not recommended. If you experiment, put a container of water in the oven.

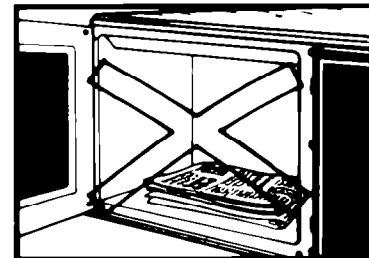

DO NOT use newspaper or other printed paper in the oven. Fire could result.

DO NOT dry flowers, fruit, herbs, wood, paper, gourds or clothes in the oven. Fire or other hazards may result.

General information

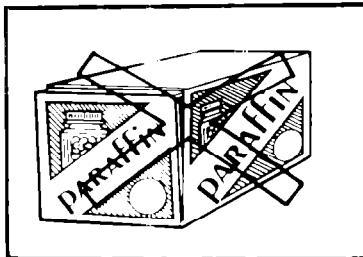

DO NOT try to melt paraffin wax in the oven. Fire or other hazards may result.

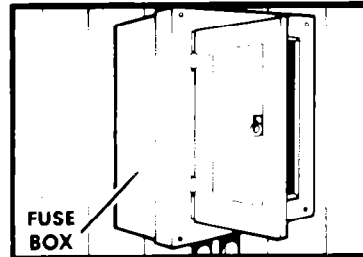

If your electric power line voltage is less than the normal 120 volts, cooking times may be longer.

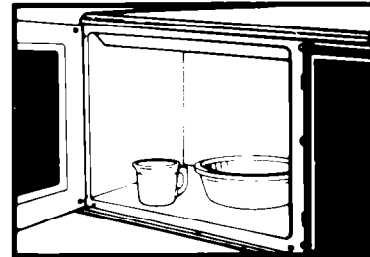

To test a dish for safe use, put it into the oven with a cup of water **beside it**. Cook on high Cook Power for one minute. **If the dish gets hot and water stays cool, do not use it.**

If you need service or assistance, we suggest you follow these five steps:

1. Before calling for assistance...

Performance problems often result from little things you can find and fix yourself without tools of any kind:

If nothing operates:

- Is the power supply cord plugged into a live circuit with the proper voltage? (See page 8.)
- Have you checked your home's main fuses or circuit breaker box?
- Have you checked the electric company for a power failure?

If the microwave oven will not run:

- Is the timer set?
- Is the door firmly closed and latched?
- Did you touch START/CANCEL?
- Did you follow the directions exactly?

If the Display shows a time counting down but the oven is not cooking:

- Is the oven door closed completely?

If the microwave oven cooking times seem too long:

- Is the electric supply to your home low or lower than normal? Your electric company can tell you if the line voltage is low.
- Is the Cook Power set correctly?
- Are you allowing for more time when cooking more food at one time?

If the fan seems to be running slower than usual:

- Has the oven been stored in a cold area? The fan will run slower until the oven warms up to normal room temperature.

2. If you need assistance*...

Call Whirlpool COOL-LINE® service assistance telephone number. Dial free from anywhere in the U.S.:

1-800-253-1301

and talk with one of our trained Consultants. The Consultants can instruct you in how to obtain satisfactory operation from your appliance or, if service is necessary, recommend a qualified service company in your area.

3. If you need service*...



Whirlpool has a nationwide network of franchised TECH-CARE® service Companies. TECH-CARE service technicians are trained to fulfill the product warranty and provide after-

warranty service, anywhere in the United States. To locate TECH-CARE service in your area, call our COOL-LINE service assistance telephone number (see Step 2) or look in your telephone directory Yellow Pages under:

APPLIANCES - HOUSEHOLD -
MAJOR - SERVICE & REPAIR

ELECTRICAL APPLIANCES -
MAJOR - REPAIRING & PARTS

OR

WHIRLPOOL APPLIANCES
FRANCHISED TECH-CARE SERVICE

WHIRLPOOL APPLIANCES
FRANCHISED TECH-CARE SERVICE

SERVICE COMPANIES

SERVICE COMPANIES

XYZ SERVICE CO
123 MAPLE

999-9999

XYZ SERVICE CO
123 MAPLE

999-9999

OR

WASHING MACHINES, DRYERS
& IRONERS - SERVICING

WHIRLPOOL APPLIANCES
FRANCHISED TECH-CARE SERVICE

SERVICE COMPANIES

XYZ SERVICE CO
123 MAPLE

999-9999

4. If you have a problem*...

Call our COOL-LINE service assistance telephone number (see Step 2) and talk with one of our Consultants, or if you prefer, write to:

Mr. Robert Stanley
Division Vice President
Whirlpool Corporation
2000 M-63
Benton Harbor, MI 49022

5. If you need FSP® replacement parts*...

FSP is a registered trademark of Whirlpool Corporation for quality parts. Look for this symbol of quality whenever you need a replacement part for your Whirlpool appliance. FSP replacement parts will fit right and work right, because they are made to the same exacting specifications used to build every new Whirlpool appliance.

To locate FSP replacement parts in your area, refer to Step 3 above or call the Whirlpool COOL-LINE service assistance number in Step 2.

*If you must call or write, please provide: model number, serial number, date of purchase, and a complete description of the problem. This information is needed in order to better respond to your request for assistance.

**SOLID-STATE TOUCH CONTROL
PARTS AND FEATURES
COVERED BY YOUR WARRANTY**

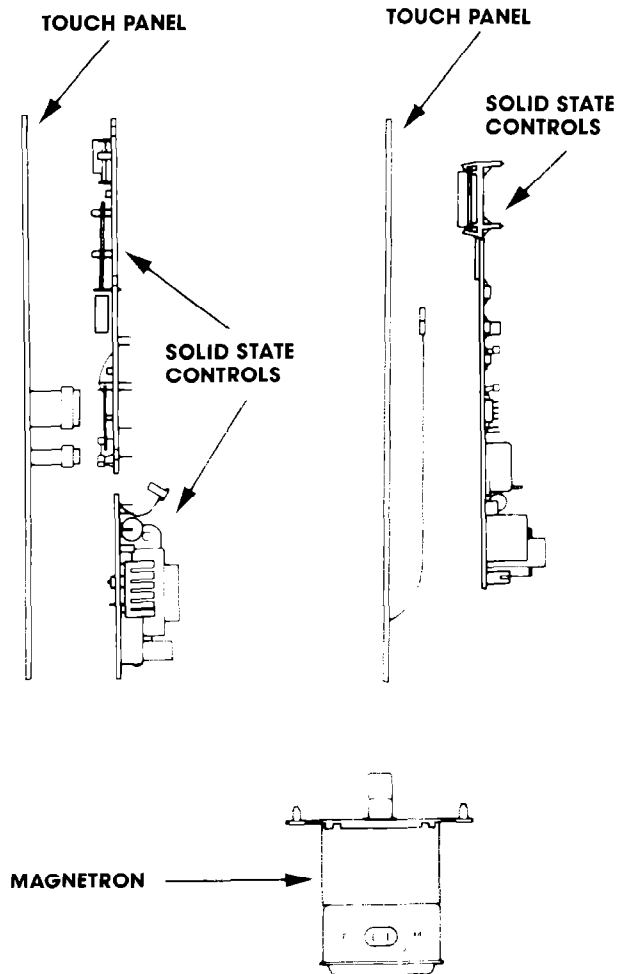

WHIRLPOOL® FULL SIZE COUNTERTOP MICROWAVE OVEN WARRANTY

LENGTH OF WARRANTY	WHIRLPOOL WILL PAY FOR
FULL ONE-YEAR WARRANTY From Date of Purchase	FSP® replacement parts and repair labor to correct defects in materials or workmanship. Service must be provided by a franchised TECH-CARE® service company.
LIMITED FOUR-YEAR WARRANTY Second Through Fifth Year From Date of Purchase	FSP replacement parts for solid-state touch control system if defective in materials or workmanship. (Touch Control models only.) The solid-state touch control parts are shown on page 15.
LIMITED NINE-YEAR WARRANTY Second Through Tenth Year From Date of Purchase	FSP replacement magnetron tube if defective in materials or workmanship. The magnetron is shown on page 15.
WHIRLPOOL WILL NOT PAY FOR	
<p>A. Service calls to:</p> <ol style="list-style-type: none"> 1. Correct the installation of the microwave product. 2. Instruct you how to use the microwave product. 3. Replace house fuses or correct house wiring. 4. Replace owner accessible light bulbs. <p>B. Repairs when microwave product is used in other than normal, single-family household use.</p> <p>C. Pick up and delivery. This product is designed to be repaired in the home.</p> <p>D. Damage to microwave product caused by accident, misuse, fire, flood, acts of God or use of products not approved by Whirlpool.</p> <p>E. Any labor costs during the limited warranties.</p>	

WHIRLPOOL CORPORATION SHALL NOT BE LIABLE FOR INCIDENTAL OR CONSEQUENTIAL DAMAGES. Some states do not allow the exclusion or limitation of incidental or consequential damages so this limitation or exclusion may not apply to you. This warranty gives you specific legal rights, and you may also have other rights which vary from state to state.

Outside the United States, a different warranty may apply. For details, please contact your franchised Whirlpool distributor or military exchange.



Part No. 3147051 Rev. B
©1987 Whirlpool Corporation

Printed in U.S.A.

ers. Dishwashers. Built-In Ovens and Surface Units. Ranges. Microwave Ovens. Trash Compactors. Room Air Conditioners. Dehumidifiers. Automatic Washers. Clothes Dryers. Freezers. Refrigerator-F

