

USER'S GUIDE

Welcome	1
Safety Instructions	2
Dryer Exhaust Tips	3
Operating Tips	4
Controls At A Glance	5-6
Special Laundry Tips	7
Care and Cleaning	8
Replacing Drum Light	8
Reversing the Door	8
Before You Call	9
Consumer Publications	10
Warranty	Back Page

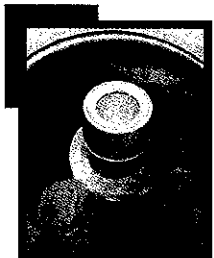

Model: LD9806

Welcome.....



Welcome and congratulations on your purchase of a Consumer Rated No.1 Maytag Dryer! Your complete satisfaction is very important to us. For best results, we suggest reading this material to help acquaint you with proper operating and maintenance procedures.

Should you need assistance, it is helpful to:

1) Have complete model and serial number identification of your dryer. This is located on a data plate in the lower right corner of the door opening.

Model Number

Serial Number

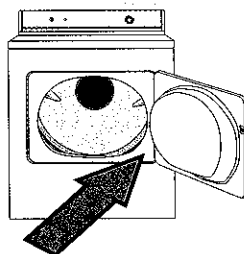

2) Have proof of original date of purchase.

Please attach your sales receipt here.

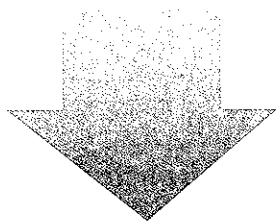

For additional questions, please contact us:

Maytag Consumer Information
One Dependability Square
Newton, Iowa 50208
(515) 791-8911
(Mon.-Fri., 8am-5pm Central Time)
Internet: <http://www.maytag.com>

NOTE: In our continuing effort to improve the quality of our appliances, it may be necessary to make changes to the appearance without revising this guide.

Important Safety Notice & Warning.....

The California Safe Drinking Water and Toxic Enforcement Act of 1986 (Proposition 65) requires the Governor of California to publish a list of substances known to the State of California to cause cancer or reproductive harm, and requires businesses to warn customers of potential exposures to such substances.

Users of this appliance are hereby warned that the burning of gas can result in low-level exposure to some of the listed substances, including benzene, formaldehyde and soot, due primarily to the incomplete combustion of natural gas or liquid petroleum (LP) fuels. Exhaust ducts should be kept free of obstructions and properly exhausted dryers will minimize exposure.

⚠ WARNING — For your safety the information in this manual must be followed to minimize the risk of fire or explosion or to prevent property damage, personal injury or death.

- Do not store or use gasoline or other flammable vapors and liquids in the vicinity of this or any other appliance.
- **WHAT TO DO IF YOU SMELL GAS**
 - Do not try to light any appliance.
 - Do not touch any electrical switch; do not use any phone in your building.
 - Clear the room, building or area of all occupants.
 - Immediately call your gas supplier from a neighbor's phone. Follow the gas supplier's instructions.
 - If you cannot reach your gas supplier, call the fire department.

Installation and service must be performed by a qualified installer, service agency or the gas supplier.

Important Safety Instructions.....

⚠ WARNING — To reduce the risk of fire, electric shock or injury to persons when using your appliance, follow basic precautions, including the following:

1. Read all instructions before using the appliance.
2. To avoid the possibility of fire or explosion:
 - a. Do not dry items that have been previously cleaned in, washed in, soaked in, or spotted with gasoline, dry-cleaning solvents, other flammable or explosive substances as they give off vapors that could ignite or explode. Any material on which you have used a cleaning solvent, or which is saturated with flammable liquids or solids, should not be placed in the dryer, until all traces of these flammable liquids or solids and their fumes have been removed. There are many highly flammable items used in homes, such as: acetone, denatured alcohol, gasoline, kerosene, some liquid household cleaners, some spot removers, turpentine, waxes and wax removers.
 - b. Items containing foam rubber (may be labeled latex foam) or similarly textured rubber-like materials must not be dried on a heat setting. Foam rubber materials when heated, can under certain circumstances produce fire by spontaneous combustion.
3. Do not allow children to play on or in the appliance. Close supervision of children is necessary when the appliance is used near children.
4. Before the appliance is removed from service or discarded, remove the door to the drying compartment.
5. Do not reach into the appliance if the drum is moving.
6. Do not install or store this appliance where it will be exposed to the weather.
7. Do not tamper with controls.
8. Do not repair or replace any part of the appliance or attempt any servicing unless specifically recommended in published user-repair instructions that you understand and have the skills to carry out.
9. Do not use fabric softeners or products to eliminate static unless recommended by the manufacturer of the fabric softener or product.
10. Clean the lint screen before or after each load.
11. Keep the area around the exhaust opening and surrounding areas free from lint accumulation, dust and dirt.
12. The interior of the dryer and exhaust duct should be cleaned periodically by qualified service personnel.
13. This appliance must be properly grounded. Never plug the appliance cord into a receptacle which is not grounded adequately and in accordance with local and national codes. See installation instructions for grounding this appliance.

⚠ WARNING — Do not place into your dryer items that have been spotted or soaked with vegetable oil or cooking oil. Even after being washed, these items may contain significant amounts of these oils. The remaining oil can ignite spontaneously. The potential for spontaneous ignition increases when the items containing vegetable oil or cooking oil are exposed to heat. Heat sources, such as your clothes dryer, can warm these items, allowing an oxidation reaction in the oil to occur. Oxidation creates heat. If this heat cannot escape, the items can become hot enough to catch fire. Piling, stacking or storing these kinds of items may prevent heat from escaping and can create a fire hazard.

All washed and unwashed fabrics that contain vegetable oil or cooking oil can be dangerous. Washing these items in hot water with extra detergent will reduce, but will not eliminate, the hazard. Always use the "cool down" cycle for these items to reduce the items' temperature. Never remove these items from the clothes dryer hot or interrupt the drying cycle until the items have run through the "cool down" cycle. Never pile or stack these items when they are hot.

Save These Instructions



Dryer Exhaust Tips

WARNING — Plastic or nonmetal flexible duct presents a potential fire hazard.

Do

Read the installation instructions and the user's guide.

Do

Let your dryer exhaust the air easily.

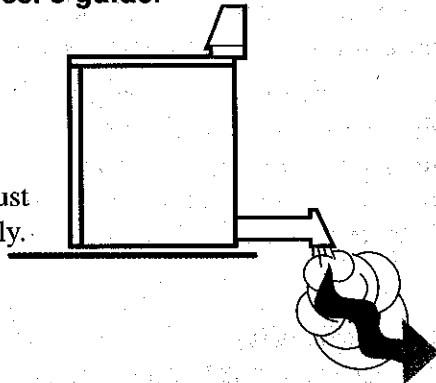

Do

Use 4 inch diameter rigid metal duct. Tape all joints. Never use lint-trapping screws.

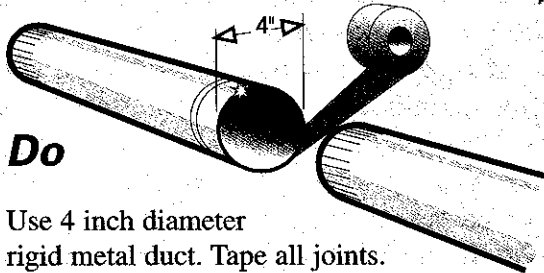

Do

Keep duct runs as straight as possible.

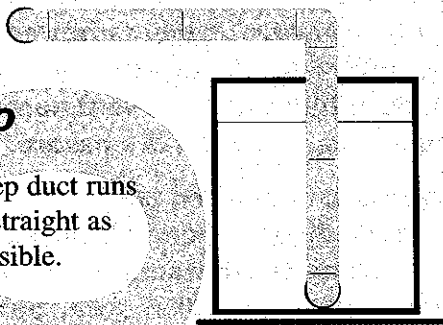

Do

Clean all old ducts before installing your new dryer. Be sure vent flap opens and closes freely.

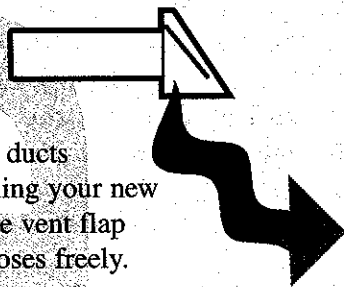

Don't

Let a poor exhaust system cause slow drying.

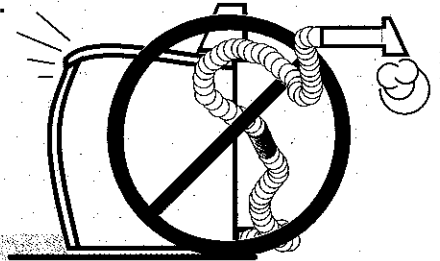

Don't

Restrict your dryer with a poor exhaust system.

Don't

Use plastic, thin foil, or non-metal flexible duct.

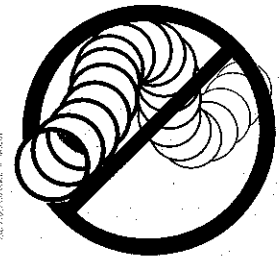

Don't

Use longer than necessary duct runs with many elbows.

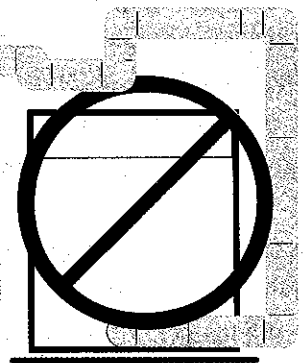

Don't

Allow crushed or clogged ducts and vent.

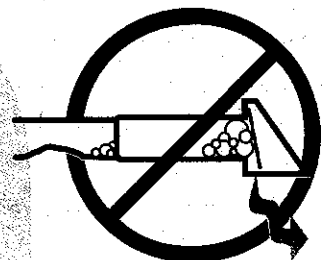

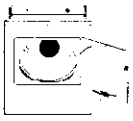

Operating Tips

Clean the Lint Filter...

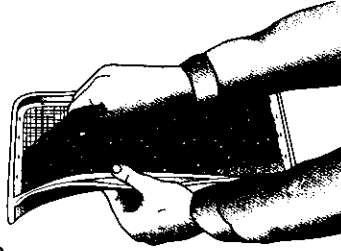

- after each load.
- to shorten drying time.
- to operate more energy efficient.

NOTE: Do not operate the dryer without the lint filter in place.

Load the Dryer Properly...

- by placing only one washload in the dryer at a time.
- by avoiding very small loads or mixed loads.
- by adding one or more similar items to the dryer when only one or two articles need drying. This improves the tumbling action and drying efficiency.

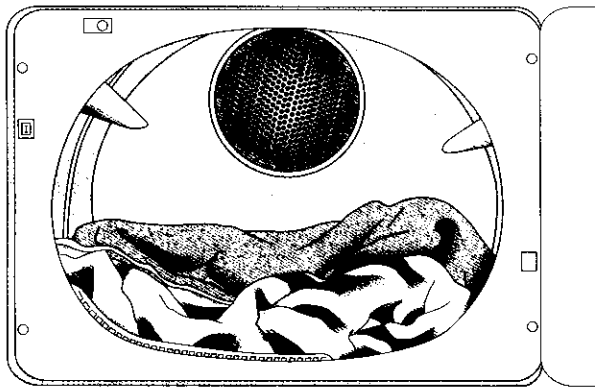

Use A Drying Rack...

(Found in select models or purchased separately from your dealer using part #LAX1000XXX.)

- to dry items, such as sneakers, pillows, caps, stuffed toys, washable sweaters, etc. inside the dryer without tumbling. (Make sure nothing hangs over the edge of the rack.)
- with a Time Dry heat cycle or an Air Fluff cycle according to care label recommendations.
- by positioning the rack in the tumbler with the front facing you. The legs should rest firmly on the front and back of the drum.

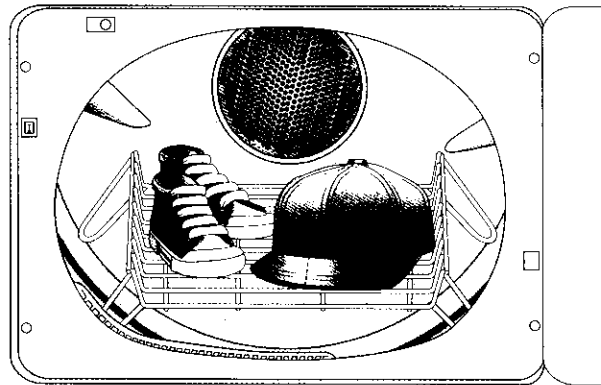

Check the Moisture Monitor...

Indicator lights in the moisture monitor will display when an IntelliDry cycle is in operation. The top light will blink on and off. As loads dry, there will be longer pauses between each blink. No lights will display during Time Dry.

The bottom light in the monitor will remain on until the cool down portion of the cycle starts. During cool down the dryer continues to tumble the load in unheated air to help minimize wrinkling.

NOTE: The top monitor light may not blink when small loads of heavy, bulky items are dried, such as large rugs or sweaters.

Add A Fabric Softener Sheet... (If So Desired)

- after loading the dryer.
- to control static cling.
- before the load becomes warm. This helps prevent greasy-looking softener stains.
- and remove any used softener sheets from the dryer to prevent greasy-looking softener stains.

Controls At A Glance

Step 1 Select Cycle

IntelliDry EASY CARE/PERMANENT PRESS automatically senses the moisture in the load and shuts off when the selected dryness level is reached. Permanent Press minimizes wrinkles of man-made fabrics such as acrylic, nylon, polyester, or blends by providing extended “cooldown” tumbling of the load in unheated air at the end of the cycle. Simply set the control to the desired dryness level (more dry – less dry) and press the START button. ▲ is the initial preferred setting for the majority of loads.

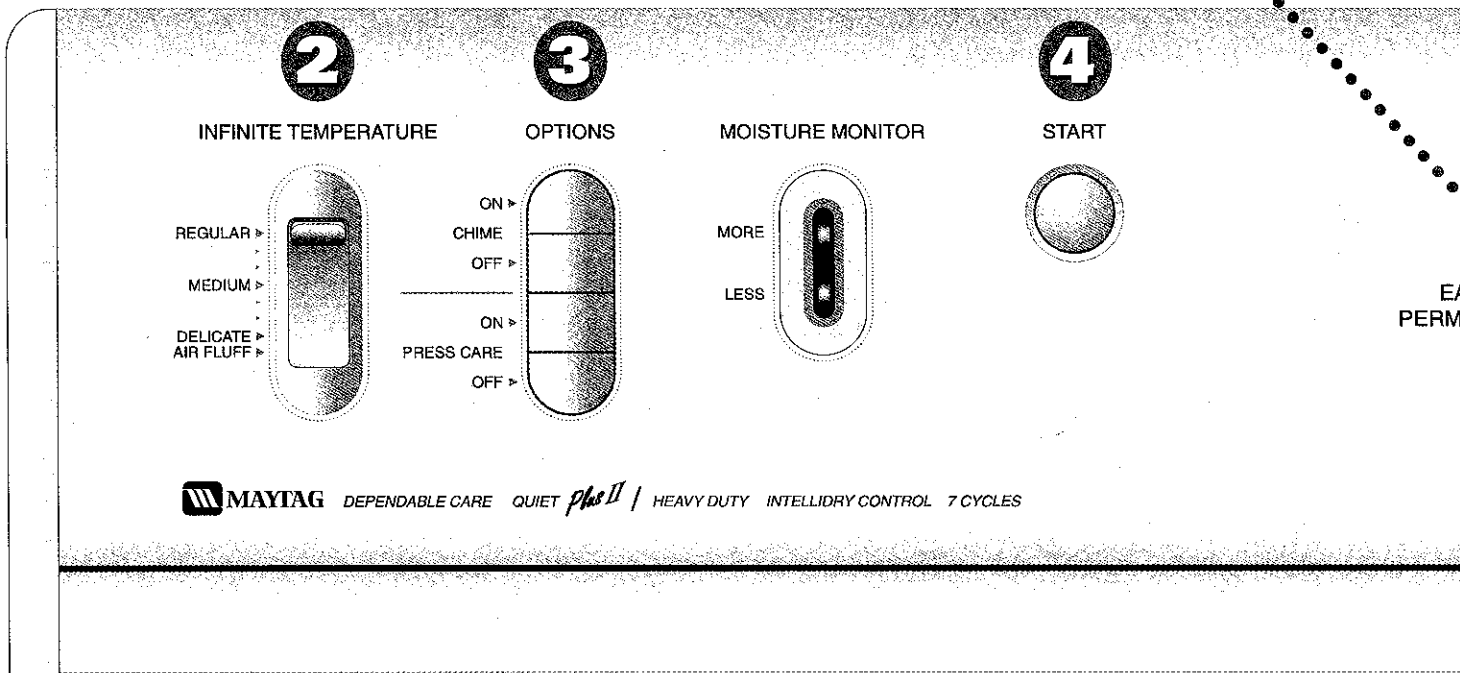

Step 2 Select Temperature

- REGULAR** – for sturdy cottons or those labeled “Tumble Dry”.
- MEDIUM** – for permanent press, synthetics, lightweight cottons or items labeled “Tumble Dry Medium”.
- DELICATE** – for heat sensitive items labeled “Tumble Dry Low” or “Tumble Dry Warm”.
- AIR FLUFF** – for sensitive loads or items needing freshening. Tumbles without heat.

Step 3 Select Options

- CHIME ON** – turns on the end of cycle signal.
- CHIME OFF** – turns off the end of cycle signal.
- PRESS CARE ON** – provides approximately 20 minutes of tumbling in unheated air after the Permanent Press cycle to prevent wrinkling.
- PRESS CARE OFF** – cancels the additional tumbling in unheated air.

Note: The dial can be turned in either direction to select a cycle. Once started, the dial will not advance at a specific rate during the Auto Dry cycles. At first the dial may not advance at all. Toward the end of the cycle (when the load begins to dry) the dial will advance at a more regular rate and much more quickly. This is normal operation.

IntelliDry REGULAR automatically senses the moisture in the load and shuts off when the selected dryness level is reached. This cycle is designed for loads such as towels, underwear, t-shirts, jeans, etc. Set the control to the desired dryness level (more dry – less dry) and press START. ▲ is the initial preferred setting for the majority of loads.

Features may vary according to model.

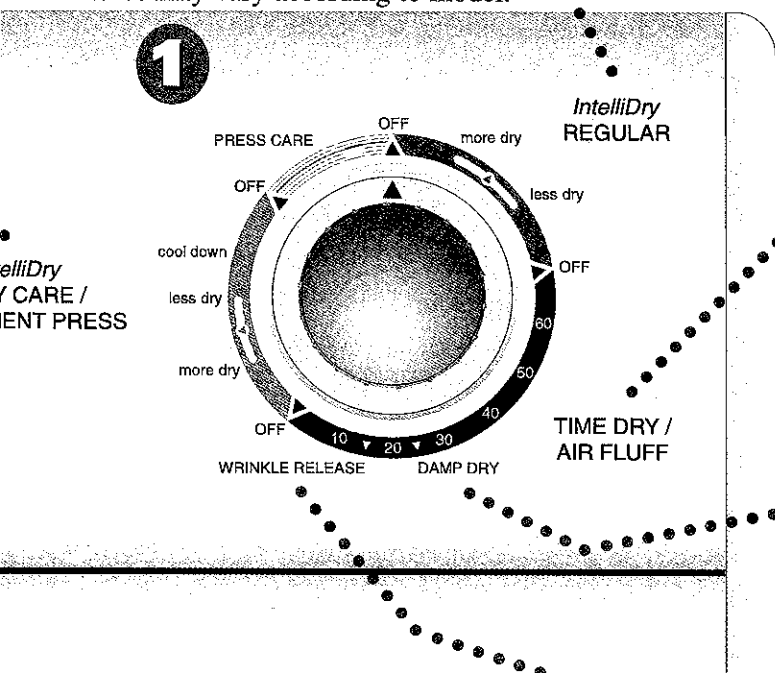

TIME DRY/AIR FLUFF may be selected for any load if the IntelliDry sensor system is not desired. Set the control to the desired number of minutes and choose the appropriate drying temperature for the load. Press START.

DAMP DRY is designed to “partially” dry items. It provides approximately 20 minutes of heated tumbling and 5 minutes of cooldown tumbling without heat.

Step 4 Press Start

Push this button to start the dryer. The dryer door must be shut for the dryer to operate. If the door is opened during the cycle, the start button must be pushed again to resume the cycle once the door is closed.

When the cycle is complete, a signal will sound momentarily.

WRINKLE RELEASE will release wrinkles from items that are clean and dry but slightly wrinkled. Such as from a crowded closet or suitcase or from sitting in the dryer too long after the end of the cycle. It provides 10 minutes of heated tumbling and 5 minutes of cooldown tumbling without heat.



Special Laundry Tips

Please follow the care label or manufacturer's instructions for drying special items. If care label instructions are not available, use the following information as a guide.

ITEM	LAUNDERING TIPS
Bedspreads & Comforters	<ul style="list-style-type: none"> • Follow the care label instructions or dry on the Regular cycle. • Block into shape and be sure it is thoroughly dry before using or storing.
Blankets	<ul style="list-style-type: none"> • Dry only one blanket at a time for best tumbling action. • Be sure it is thoroughly dry before using or storing.
Curtains & Draperies	<ul style="list-style-type: none"> • Use the Permanent Press cycle to help minimize wrinkling. • Dry these in small loads for best results and remove as soon as possible.
Cloth Diapers	<ul style="list-style-type: none"> • Use the Regular cycle to make diapers come out soft and fluffy. • Avoid laundering more than 3 dozen diapers in one load.
Down-filled Items (jackets, sleeping bags, comforters, etc.)	<ul style="list-style-type: none"> • Use the Regular cycle and a delicate temperature setting. • (Place a clean pair of sneakers in the dryer with the item to fluff the down comforters, etc.) Adding a couple of dry towels shortens dry time and absorbs moisture.
Foam Rubber (rug backs, stuffed toys, certain shoulder pads, etc.)	<ul style="list-style-type: none"> • DO NOT dry on a heat setting. Use the Air Fluff (no-heat) cycle. • These may dry best if placed on a drying rack in the dryer. • ⚠ WARNING - Drying a rubber item with heat may damage it or be a fire hazard.
Pillows	<ul style="list-style-type: none"> • DO NOT dryer-dry kapok or foam pillows. • Use the Regular cycle. • Add a couple of dry towels and a pair of clean sneakers to help the tumbling action and to fluff the item.
Plastics (shower curtains, outdoor furniture covers, etc.)	<ul style="list-style-type: none"> • Use the Air Fluff cycle or dry on a drying rack in the dryer on a low temperature.

Avoid Dryer Drying...

- *Fiberglass Items (curtains, draperies, etc.)*
- *Woolens, unless recommended on the label.*
- *Vegetable or cooking oil soaked items. (See pg.2)*



Care and Cleaning.....

Control Panel – clean with a soft, damp cloth. Do not use abrasive substances.

Tumbler – remove any stains (such as crayon, ink pen or fabric dye) with an all purpose cleaner. Then tumble old towels or rags to remove any excess stain or cleaning substance.

Cabinet – wipe off any marks with soap and water. Use an appliance wax once a year if desired.

Dryer Exhaust System – should be inspected and cleaned once a year to maintain optimum performance. The outside exhaust hood should be cleaned more frequently to ensure proper operation. (Refer to the Installation Instructions for more information.)



Replacing Drum Light.....

(select models)

- 1) Unplug or disconnect the dryer.
- 2) Carefully remove the bulb from the top center of the door opening by turning counterclockwise.
- 3) Replace with a 7 watt, 120 volt candelabra base bulb (7C7).
- 4) Reconnect dryer to power supply.



Reversing the Door.....

The dryer door is designed with the flexibility to swing from left to right or from right to left depending on your installation needs. Simply follow these steps:

- 1) Remove and keep hinge & latch hole covers.
- 2) Rest dryer door on your knee.
- 3) Remove 4 screws from the door hinges.
- 4) Turn door upside down and support on your other knee.
- 5) Place a screw in the top hole of the upper hinge first and tighten to position the door.
- 6) Insert a screw in the lower hinge and tighten.

- 7) Close and open door to check for proper fit of door in the opening. Adjust door if needed.
- 8) Insert and tighten remaining screws.
- 9) Put hinge & latch hole covers in opposite side.

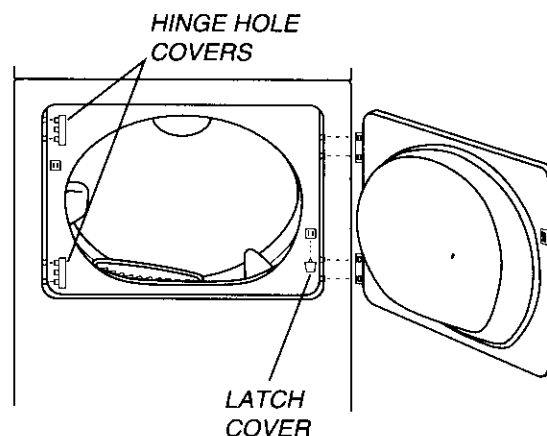



Dryer Warranty.....

Full One Year Warranty

For one(1) year from the date of original retail purchase, any part which fails in normal home use will be repaired or replaced free of charge.

Limited Parts Warranty

After the first year from date of original retail purchase, through the time periods listed below, the designated parts which fail in normal home use will be repaired or replaced free of charge for the part itself, with the owner paying all other costs, including labor.

Second Year

All Parts.

Third Through Fifth Year

All parts of the solid state controls (if so equipped).

Additional Limited Warranty Against Rust

Should any of the parts listed below rust during the five year period starting from the date of retail purchase, repair or replacement will be made free of charge during the first year. After the first and through the fifth year, repair or replacement will be made free of charge for the part itself, with the owner paying all other costs, including labor. Parts covered by this warranty are the exterior cabinet, including door, tumbler and tumbler front and back.

This full warranty and the limited warranties apply when the appliance is located in the United States or Canada. Appliances located elsewhere are covered by the limited warranties only, which includes parts which fail during the first year.

Canadian Residents

This warranty covers only those appliances installed in Canada that have been listed with Canadian Standards Association unless the appliances are brought into Canada due to transfer of residence from the United States to Canada.

To Receive Warranty Service

To locate an authorized service company in your area, contact the Maytag dealer from whom your appliance was purchased or call Maytag Customer Service. Should you not receive satisfactory warranty service, call or write:

Maytag Customer Assistance
c/o Maytag Customer Service
P.O. Box 2370
Cleveland, TN 37320-2370
US **1-800-688-9900**
CANADA **1-800-688-2002**

When contacting Maytag Customer Service be sure to provide the model and serial numbers of your appliance, the name and address of the dealer from whom you purchased the appliance and the date of purchase.

This Warranty gives you specific legal rights, and you may also have other rights which vary from state to state.

Should you still have a problem, write to: Major Appliance Consumer Action Program (MACAP), 20 North Wacker Drive, Chicago, Illinois 60606, MACAP is an industry sponsored but independent group of consumer experts who receive and act on complaints from appliance owners.

NOTE: When writing about an unsolved service problem, please include the following information:

- (a) Your name, address and telephone number;
- (b) Model number and serial number (found on control panel cover) of your appliance;
- (c) Name and address of your dealer and date the appliance was bought;
- (d) A clear description of the problem you are having;

MAYTAG • One Dependability Square • Newton, Iowa 50208