

Use

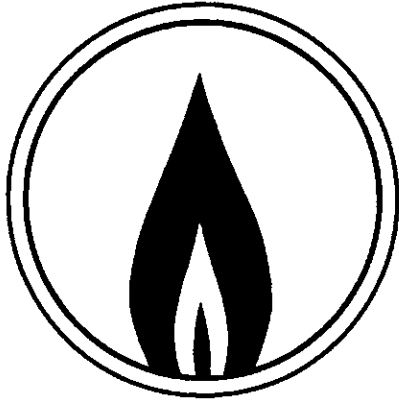

And

Care

Instructions for your Gas Range with "T" Clock

CONTENTS

SAFETY INSTRUCTIONS	1-3	Oven burner	10
ELECTRONIC CONTROLLER	4	Oven racks	10
FEATURES	5-6	Hints	10
Self-clean oven	5	Preheating	10
Automatic oven cooking	6	How to set oven for baking or roasting	11
USING YOUR COOKTOP	7-8	Common baking problems chart	12
Pilotless ignition	7	How to set oven for broiling	13
Cooktop	7	How to broil	14
Burner grates	7	Broiling chart	14
Surface burners	7	MAINTENANCE	15-16
Lighting surface burners	8	Electrical connection	15
Selecting flame size	8	Remove range for cleaning	15
Proportional valve	8	Anti-tip bracket	15
USING YOUR OVEN	9-14	Oven light replacement	15
Oven door	9	Backguard light	15
Oven bottom	9	Leveling legs	16
Storage drawer	9	Proportional valve adjustment	16
Fan	9	CARE AND CLEANING CHART	17
Oven characteristics	10	SERVICE	18
Pilotless ignition	10	Troubleshooting chart	18
		WARRANTY	19

INSTALLER Please leave this manual with this appliance.

CONSUMER To save you time, energy and money, read and keep this manual for future reference.

Complete model and serial numbers are found on the rating plate which is located under the lift-up cooktop on the right side. On ranges equipped with sealed surface burners, the rating plate is located on the oven front frame. Open oven door to locate rating plate.

Model number: _____

Serial number: _____

Date of purchase: _____

SAFETY INSTRUCTIONS

WARNING: If the information in this manual is not followed exactly, a fire or explosion may result causing property damage, personal injury or death.

- Do not store or use gasoline or other flammable vapors and liquids in the vicinity of this or any other appliance.
- **WHAT TO DO IF YOU SMELL GAS**
 - Do not try to light any appliance.
 - Do not touch any electrical switch; do not use any phone in your building.
 - Immediately call your gas supplier from a neighbor's phone. Follow the gas supplier's instructions.
 - If you cannot reach your gas supplier, call the fire department.
- Installation and service must be performed by a qualified installer, service agency or the gas supplier.

GENERAL

No cooking appliance should be used as a space heater. This instruction is based on safety considerations to prevent potential hazard to the consumer as well as damage to the appliance.

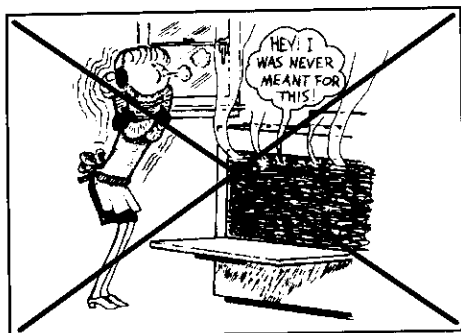

If range is installed near a window, proper precautions should be taken to prevent curtains from blowing over burners creating a FIRE HAZARD.

Keep area around appliance clear and free from combustible materials, gaso-

line, and other flammable vapors and materials.

Have the installer show you the location of the gas shut off valve and how to shut it off in an emergency.

Your appliance is vented through the base of the backguard. Never block oven vent or air intakes. Do not obstruct the flow of combustion and ventilation air. Restriction of air flow to the burner prevents proper performance.

Avoid touching oven vent area while oven is on and for several minutes after oven is turned off. Some parts of the vent and surrounding area become hot enough to cause burns.

Do not use cooktop or oven as a storage area for food or cooking utensils. This instruction is based on safety considerations to prevent potential hazard to user and to the appliance.

Misuse of appliance doors, such as stepping, leaning or sitting on the door, may result in possible tipping of the appliance or breakage of door and serious injuries.

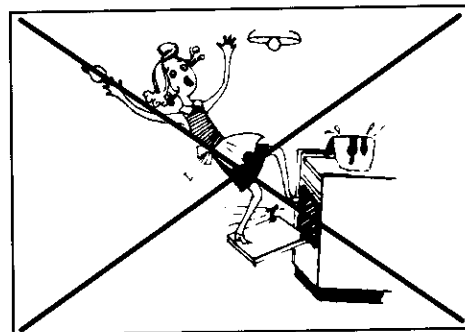

IN CASE OF FIRE:

1. Turn off range controls.
2. Smother fire or flame with baking soda, dry chemical, or a foam-type extinguisher. Do not use water on grease fires.

SAFETY INSTRUCTIONS

CHILD SAFETY

Do not leave children alone or unsupervised near the appliance when it is in use or is still hot. Children should never be allowed to sit or stand on any part of the appliance. Children must be taught that the appliance and utensils in it can be hot. Children should be taught that an appliance is not a toy. They should not be allowed to play with controls or other parts of the unit. Let hot utensils cool in a safe place, out of reach of small children.

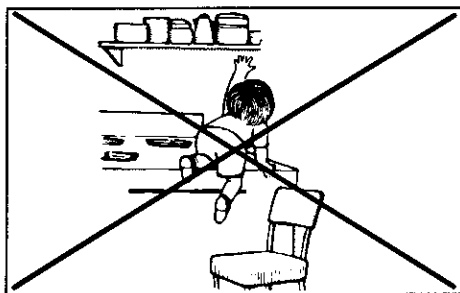

CAUTION: Do not store items of interest to children in cabinets above an appliance or on the backguard of a range. Children climbing on the appliance to reach items could be seriously injured. Do not use an appliance as a step stool to cabinets above.

ANTI-TIP DEVICE

To reduce the risk of tipping of the appliance from unusual usage or by excessive loading of the oven door, the appliance must be secured by a properly installed anti-tip device. To check if device is installed properly: Use a flashlight and look underneath range to see that one of the rear leveling legs is engaged in the bracket slot. When removing appliance for cleaning, be sure anti-tip device is engaged when range is replaced. The anti-tip device secures the rear leveling leg to the floor, when properly engaged.

CLEANING

Turn off all controls and wait for range parts to cool before touching or cleaning them. Do not touch the burner grates or surrounding areas until they have had sufficient time to cool.

Touching a hot oven light bulb with a damp cloth could cause the bulb to break. Should the bulb break, disconnect power to the range before trying to remove the bulb to avoid electrical shock.

Clean range with caution. If a wet sponge or cloth is used to wipe spills on a hot cooking area, be careful to avoid steam burns. Some cleaners can produce noxious fumes if applied to a hot surface.

GREASE

Use extreme caution when moving the grease kettle or disposing of hot grease.

Hot grease is flammable. Avoid letting grease deposits collect around appliance, range hood, or vent fan. Do not leave container of grease around a cooking appliance. Always let quantities of hot fat used for deep fat frying cool before attempting to move or handle. In the event of a grease fire, DO NOT attempt to move pan. Cover pan with a lid to extinguish flame and turn surface burner off. Do not douse flame with water. Use a dry chemical or foam-type fire extinguisher, if available, or sprinkle heavily with baking soda.

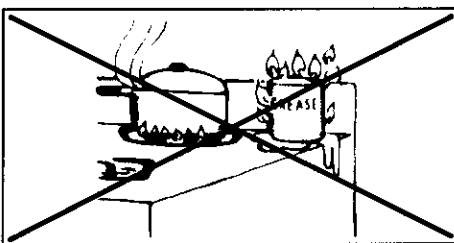

Spills or boilovers which contain grease should be cleaned up as soon as possible. If they are allowed to accumulate, they could create a FIRE HAZARD.

COOKING SAFETY

Always adjust surface burners flame so that it does not extend beyond the bottom of utensil. This instruction is based on safety considerations.

Never leave a surface cooking operation unattended especially when using a high heat setting. Boilovers cause smoking and greasy spillovers may ignite.

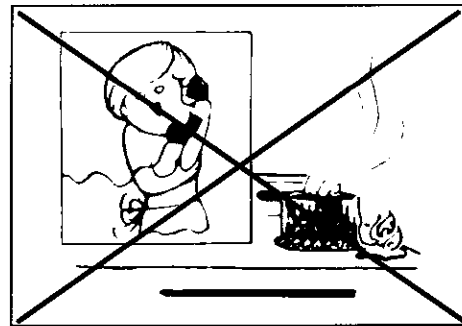

Be sure you know which knob controls which surface burner. Always make sure the correct burner is turned on and that the burner has ignited. When cooking is completed, turn burner off.

Use caution when wearing garments made of flammable material to avoid clothing fires. Loose fitting or long hanging-sleeved apparel should not be worn while cooking. Clothing may ignite or catch utensil handles.

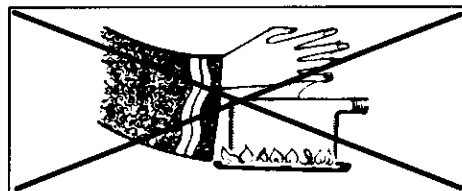

Never heat an unopened container on the surface burner or in the oven. Pressure build-up may cause container to burst resulting in serious personal injury or damage to the range.

Slide oven rack out to add or remove food, using dry, sturdy pot holders. Always avoid reaching into oven to place or remove food.

Use dry, sturdy pot holders. Damp pot holders may cause burns from steam. Dish towels or other substitutes should never be used as pot holders because they can trail across hot surface burners and ignite or get caught on range parts.

Use care when opening oven door. Let hot air or steam escape before removing or replacing food. Always place oven racks in the desired positions while oven is cool. If a rack must be moved while hot, be careful to avoid contact of pot holders with oven burner flame.

SAFETY INSTRUCTIONS

STORAGE ABOVE RANGE

To eliminate the hazard of reaching over hot surface burners, cabinet storage should not be provided directly above a unit. If such storage is provided, it should be limited to items which are used infrequently and which are safely stored in an area subjected to heat from an appliance. Temperatures in storage areas above the unit may be unsafe for some items, such as volatile liquids, cleaners or aerosol sprays.

UTENSIL SAFETY

Use only pans that have flat bottoms and handles that are easily grasped and stay cool. Avoid using unstable, warped, easily tipped or loose handled pans. Do not use pans if their handles twist and cannot be tightened. Pans that are heavy to move when filled with food may also be hazardous.

Always place a pan of food on a surface burner before turning it on, and turn it off before removing the pan.

Always turn pan handles to the side or back of appliance, not out into the room where they are easily hit or reached by small children. To minimize burns, ignition of flammable materials and spillage due to unintentional contact with the utensil, do not extend handles over adjacent surface burners.

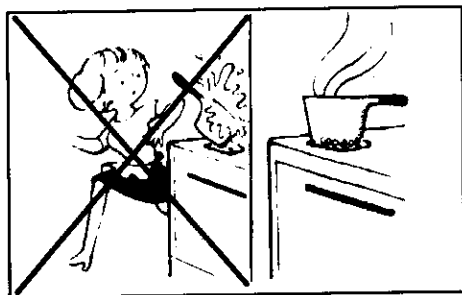

Be sure utensil is large enough to properly contain food and avoid boilovers. Pan size is particularly important in deep fat frying. Be sure pan will accommodate the volume of food that is to be added as well as the bubble action of fat. Never leave a deep fat frying operation unattended.

Never let a pan boil dry as this could damage the utensil and the appliance.

ALUMINUM FOIL

Use aluminum foil ONLY as instructed in this book. Improper use of aluminum foil may cause damage to the oven, affect cooking results, and can also result in shock and/or fire hazards.

PLASTICS

Many plastics are vulnerable to heat. Keep plastics away from parts of the appliance that may become warm or hot.

AEROSOL SPRAYS

Many aerosol-type spray cans are EXPLOSIVE when exposed to heat and may be highly flammable. Avoid their use or storage near an appliance.

SELF-CLEAN OVEN

Do not clean door gasket. The door gasket is essential for a good seal. Care should be taken not to rub, damage, or move the gasket. Do not use oven cleaners of any kind in or around any part of the self-clean oven. Clean only parts listed in this booklet. Before self-cleaning the oven, remove broiler pan, oven racks, and other utensils, and wipe off excessive spillovers.

It is normal for the cooktop of the range to become hot during a self-clean cycle. Therefore, touching or lifting the cooktop during a clean cycle should be avoided.

IMPORTANT SAFETY NOTICE AND WARNING

The California Safe Drinking Water and Toxic Enforcement Act of 1986 (Proposition 65) requires the Governor of California to publish a list of substances known to the State of California to cause cancer or reproductive harm, and requires businesses to warn customers of potential exposures to such substances.

Users of this appliance are hereby warned that the burning of gas can result in low-level exposure to some of the listed substances, including benzene, formaldehyde and soot, due primarily to the incomplete combustion of natural gas or liquid petroleum (LP) fuels. Properly adjusted burners will minimize incomplete combustion. Exposure to these substances can also be minimized by properly venting the burners to the outdoors.

VENTILATING HOOD

To reduce the hazard of storage above a range, install a ventilating hood that projects at least 5 inches beyond the bottom edge of the cabinets. Clean hood frequently to prevent grease from accumulating on hood or its filter. Should a boilover or spillover result in an open flame, immediately turn off the hood's fan to avoid spreading the flame. After thoroughly extinguishing flame, the fan may be turned on to remove unpleasant odor or smoke.

ELECTRONIC CONTROLLER

CLOCK (time-of-day)

1. Press CLOCK pad.
2. Turn SET knob until display shows correct time-of-day.
3. Press STOP/CLEAR pad to lock in time.

When power is first supplied to oven or if there is a power failure, the display will flash. Follow above instructions to set clock.

CLEAN

1. Close door.
2. Move door lock lever to the right or locked position.
3. Press CLEAN pad. ("door" will flash in display and beeps will sound if door is not locked.)
4. Oven will automatically clean for 3 hours. Select 2 or 4 hours by turning the SET knob.

See page 5 for additional information.

BROIL

1. Press BROIL pad.
2. Turn SET knob clockwise one or two clicks to select HI or LO broil.
3. Press STOP/CLEAR pad to cancel broil operation.

See pages 13 and 14 for additional information.



STOP/CLEAR

Press to cancel all operations except clock and timer.

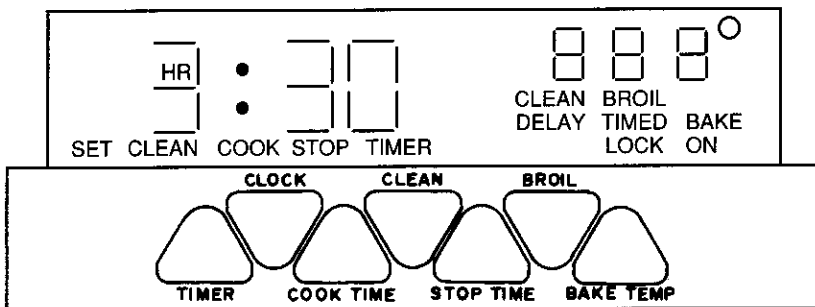

SET

Turn knob in either direction to enter time or temperature. Knob is also used to select HI/LO broil.

(NOTE: All indicator words are displayed to show their location. When oven or timer is not in use, indicator words are not displayed. Indicators are only displayed when oven is set for a cook, delayed cook, clean or timer operation.)

TIMER (minute timer)

1. Press TIMER pad.
2. Turn SET knob to desired time.
3. TIMER starts automatically. 3 beeps signal the end of the timing operation and the time-of-day reappears in the display.
4. **To cancel:** Press TIMER pad and hold for 3 seconds or turn SET knob until :00 appears in the display. Time-of-day will reappear after a 3-second delay.

ADDITIONAL INFORMATION

A beep sounds each time a pad is pressed. Three beeps signal the end of an operation. Press STOP/CLEAR to cancel an operation.

If a fault code (ex: F 1) is displayed, if control will not accept an entry, or if beeps sound, press STOP/CLEAR. See page 18 if fault code or beeps continue or if control will not accept an entry.

Function pads on some models are round – they operate as described in this booklet.

COOK TIME/STOP TIME

To begin cooking immediately:

1. Press COOK TIME pad and enter desired cooking time by turning the SET knob.
2. Press BAKE TEMP pad and enter oven temperature with SET knob.

To delay the start of cooking:

1. Press COOK TIME pad and enter cooking time with SET knob.
2. Press STOP TIME pad and enter time you wish food to stop cooking with SET knob.
3. Press BAKE TEMP pad and enter oven temperature with SET knob.

The oven will automatically turn on and off at preset times.

Press STOP/CLEAR pad to cancel end-of-cooking beeps.

See page 6 for additional information.

BAKE TEMP

1. Press BAKE TEMP pad.
2. Turn SET knob until desired oven temperature appears in the display.
3. Press STOP/CLEAR pad to cancel the baking operation.

See pages 10, 11 and 12 for additional information on baking and roasting.

TO CANCEL AN OPERATION:

Press STOP/CLEAR pad to cancel a cook, timing or clean operation.

FEATURES

SELF-CLEAN OVEN

The self-clean oven uses temperatures above normal cooking temperatures to automatically clean the entire oven.

TO OPERATE:

1. Close door and move door lock lever to the right (locked position).



2. Press CLEAN pad.

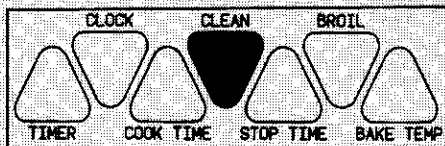

If door is not locked as described, "door" will flash in the display.

3. When the CLEAN pad is pressed, the oven will automatically clean for 3 hours.

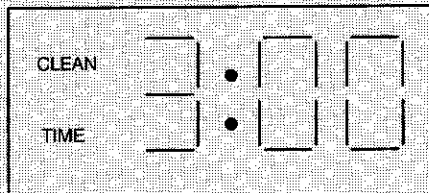

A shorter (2 hour) or longer (4 hour) clean cycle can be selected by turning the SET knob.

TO CANCEL CLEAN CYCLE:

1. Push STOP/CLEAR pad.
2. If the LOCK indicator is not displayed, the oven door can be unlocked.

If the LOCK indicator is displayed, allow oven to cool (up to one hour). Once LOCK indicator turns off, the door can be unlocked.

Door and lock lever may be damaged if the lock lever is forced to the left before the LOCK indicator turns off.

BEFORE SELF-CLEANING

Remove all pans from the oven. The racks may be left in, but will discolor and may not slide easily after cleaning.

Clean oven frame, door frame and around the oven vent with a non-abrasive cleaning agent such as Bon Ami. These areas are not exposed to cleaning temperatures and should be cleaned to prevent soil from baking on during the clean cycle.

Wipe up excess grease or spillovers from the oven bottom to prevent excessive smoking during the clean cycle.

DO NOT USE OVEN CLEANERS OR OVEN LINER PROTECTIVE COATINGS OF ANY KIND ON THE SELF-CLEAN OVEN FINISH OR AROUND ANY PART OF THE OVEN.

To prevent damage, do not clean or rub the gasket around the front oven frame. The gasket is designed to seal in heat during the clean cycle.

DURING SELF-CLEANING

When the door is locked and the CLEAN pad is pressed, the oven automatically begins to heat to cleaning temperatures.

As the oven reaches cleaning temperatures, the LOCK indicator will turn on to show that an internal lock mechanism has engaged. At this point, the oven door can not be unlocked and opened.

To prevent damage to the door and lock lever, do not force the lock lever to the left when the LOCK indicator is displayed.

About one hour after the completion of the clean cycle, the internal lock will disengage and the LOCK indicator will turn off. At this point, the lock lever can be moved to the left (unlocked position) and the door opened.

The first few times the oven is cleaned, some smoke and odor may be detected. This is normal and will reduce or disappear with use. If the oven is heavily soiled, or if the broiler pan is left in the oven, smoke and odor may occur.

It is normal for the cooktop of the range to become hot during a clean cycle. Therefore touching the cooktop during a self-clean cycle should be avoided.

As the oven heats and cools, you may hear sounds of metal parts expanding and contracting. This is normal and will not damage your appliance.

AFTER SELF-CLEANING

Some soil may leave a light gray, powdery ash which can be removed with a damp cloth. If soil remains, it indicates that the clean cycle was not long enough. The soil will be removed during the next clean cycle.

If the oven racks do not slide smoothly after a clean cycle, wipe racks and embossed rack supports with a small amount of vegetable oil to restore ease of movement.

Fine, hair-like lines may appear in the oven interior or oven door. This is a normal condition resulting from heating and cooling of the porcelain finish. These lines do not affect the performance of the oven.

FEATURES

AUTOMATIC OVEN COOKING

Automatic cooking feature is used to turn the oven on and off at the preset time-of-day. This feature can be used to delay the start of a cooking operation.

The automatic cooking feature will not operate unless the clock is functioning and is set at the correct time-of-day.

TO BAKE BY TIME with immediate START:

1. Press COOK TIME pad. "OVEN TIME" lights in the display.
2. Enter cooking time (how long you wish food to cook) by turning the SET knob.
3. Press BAKE TEMP pad. "BAKE" lights in the display.
4. Enter oven temperature by turning the SET knob until desired temperature is displayed.

The oven will automatically turn on and the display will begin to count down.
5. At the end of the preset cooking time, the oven will automatically turn off.
6. Press STOP/CLEAR pad to cancel end-of-cooking beeps.

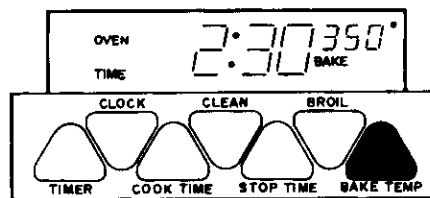
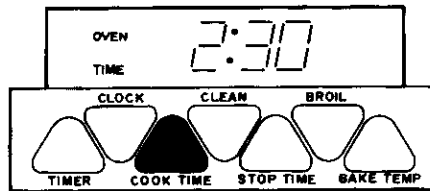

GENERAL INFORMATION

IMPORTANT: Highly perishable foods such as dairy products, pork, poultry, seafoods or stuffing are not recommended for delayed cooking. If cooking more than one food, select foods that cook for the same length of time and at the same oven temperature.

If you delay in entering a complete program, control may beep and/or the oven may turn on. Just continue entering the program as described.

To reset or cancel the program: Press the STOP/CLEAR pad.

After setting the Automatic Cooking feature, press the CLOCK pad and the time-of-day will reappear in the display. "BAKE ON" or "DELAY OVEN BAKE" and the oven temperature will remain in the display as a reminder that the oven is set for a cooking operation.

At end of cooking, continuous beeps will sound. Press STOP/CLEAR pad to cancel beeps.

TO BAKE BY TIME with delayed START:

1. Follow steps 1, 2, 3 and 4 above.
2. Press STOP TIME pad. "STOP TIME" lights in the display.
3. Enter the time you wish the oven to turn off by turning the SET knob. "DELAY OVEN STOP TIME" lights in the display.
4. Press CLOCK pad and time-of-day reappears in the display. "DELAY OVEN" remains in display to indicate that oven is set for a delayed cooking operation.

The oven will automatically turn on in time to have the food cooked by the preselected STOP TIME. The oven will automatically turn off at the preset stop time.
5. Press STOP/CLEAR pad to cancel end-of-cooking beeps.

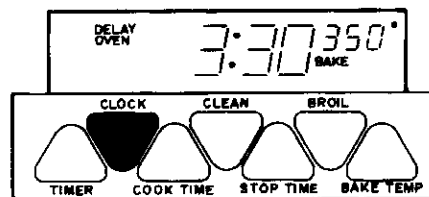
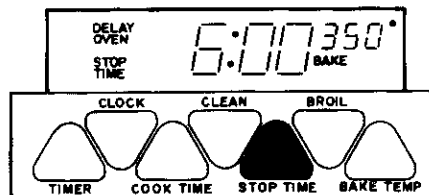

EXAMPLE

Food is to cook for 2 hours and 30 minutes at 350°F. You wish the food to be cooked by 6:00.

1. Press COOK TIME pad.
2. Turn SET knob until 2:30 (2 hours, 30 minutes) appears in the display.
3. Press BAKE TEMP pad.
4. Turn SET knob until 350° appears in the display.
5. Press STOP TIME pad.
6. Turn SET knob until 6:00 appears in the display.

The oven will turn on at 3:30; cook the food for 2 1/2 hours, and will automatically turn off at 6:00.

USING YOUR COOKTOP

PILOTLESS IGNITION

Ranges featuring pilotless ignition are equipped with ignitors that spark when any surface burner is turned to the LITE position.

Once burner lights, turn knob to the desired setting. The sparking will not stop until the knob is turned from the LITE position.

TO OPERATE SURFACE BURNER WITH PILOTLESS IGNITION DURING A POWER FAILURE:

1. Be sure all controls are in the OFF position.
2. Hold a lighted match to the desired surface burner head.
3. Turn knob to LITE. The burner will then light.
4. Adjust the flame to the desired level.

COOKTOP

To remove cooktop: When cool, first remove grates and drip bowls, if equipped. Grasp two front burner wells and lift up.

Range featuring sealed burners: Cooktop is not removable and does not lift up.

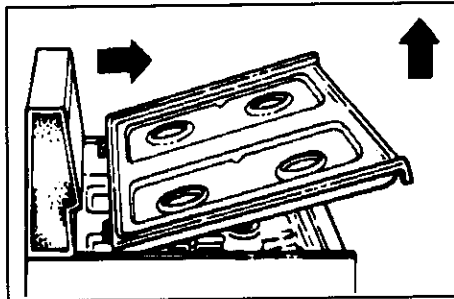

The top can be completely removed or, if equipped with a metal support rod, can rest on the rod. Support rod is located across the front of the burner box.

BURNER GRATES

Burner grates must be properly positioned before cooking. Do not operate burners without a pan on the grate. The porcelain finish may chip without a pan to absorb the intense heat.

When reinstalling square grates, place indented sides together so straight sides are at front and rear.

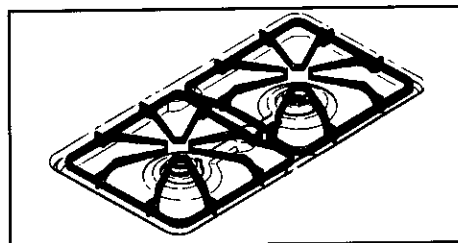

SURFACE BURNERS

Your range will feature one of these three types of surface burners: One piece uniburner, standard single burner or sealed burner. Refer to the separate Use and Care insert for instructions on the sealed burners.

Follow the instructions to the illustration that matches the burners on your range.

Uniburners and single burners are secured in place during transportation with either a shipping screw or a spring clip. Once the range is installed, these may be removed to allow quick and easy removal of the burner.

One piece uniburner

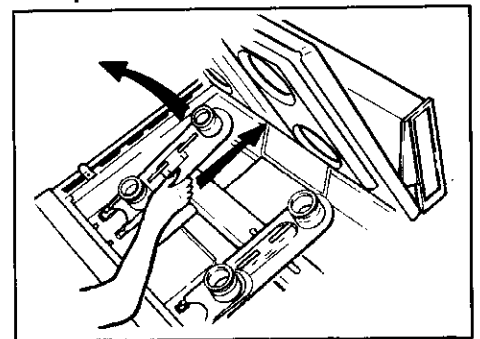

Allow burner to cool. Lift cooktop. To remove uniburner, lift up slightly and pull out. Under no circumstances are burners to be taken apart for cleaning. Uniburner can be cleaned in the dishwasher. Burner and burner tube must be dry before use.

Standard single burner

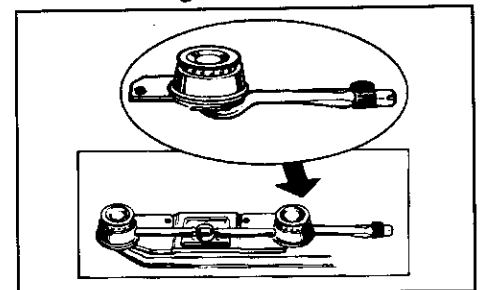

Remove or support cooktop. Grasp burner head and tilt to release tab from slot near ignitor. Lift up and toward back of cooktop until air shutter end of burner releases from valve.

USING YOUR COOKTOP

LIGHTING SURFACE BURNERS

1. Place utensil on burner grate.
2. Push in and turn knob to the LITE position.

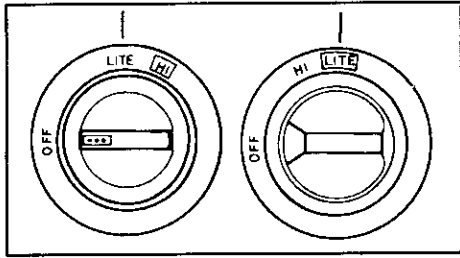

A sparking sound will be heard and the burner will light. When one burner is turned on, all ignitors will spark.

3. After the burner lights, turn knob to the desired flame size.

As the burner heats and cools, you may hear sounds of the metal expanding and contracting. This is a normal operating sound of the burner.

If flame should go out during a cooking operation, turn the burner off. IF GAS HAS ACCUMULATED AND A STRONG GAS ODOR IS DETECTED, WAIT 5 MINUTES FOR THE GAS ODOR TO DISAPPEAR BEFORE RELIGHTING BURNER.

You may hear a "popping" sound on LP gas when the surface burner is turned off. This is a normal operating sound of the burner.

A properly adjusted burner with clean ports will light within a few seconds. On natural gas, the flame will be blue with a

deeper blue inner core; there should be no trace of yellow in the flame. A yellow flame indicates an improper mixture of air/gas. This wastes fuel, so have a serviceman adjust the mixture if a yellow flame occurs. On LP gas, some yellow tipping is acceptable. This is normal and adjustment is not necessary.

SELECTING FLAME SIZE

If a knob is turned very quickly from HIGH to LOW setting, the flame may go out, particularly if burner is cold. If this occurs, turn the knob OFF. Wait several seconds, then light again.

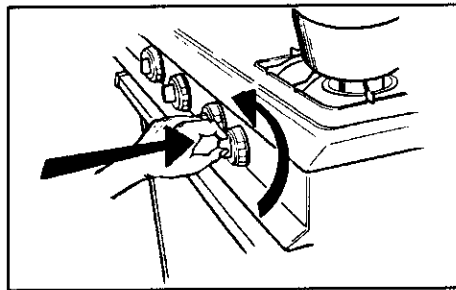

Flame should be adjusted so it does not extend beyond the edge of cooking utensil. This is for personal safety and to prevent damage to cabinets above range.

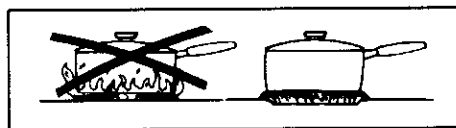

Use **HIGH** to quickly bring foods to a boil or to begin a cooking operation. Reduce to a lower setting to continue cooking.

Never leave food unattended when using a HIGH flame setting.

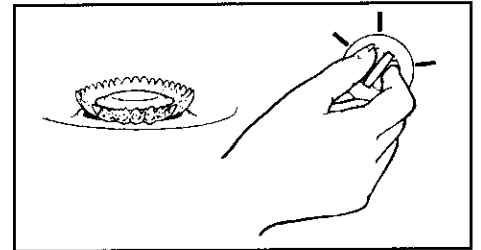

Use **LOW** to simmer or keep foods at serving temperatures. Some cooking may take place if the utensil is covered.

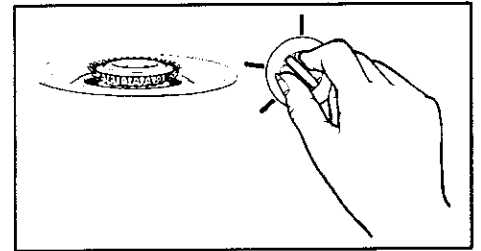

PROPORTIONAL VALVE

To obtain a lower flame size, turn knob back toward the OFF position until the desired flame size is reached. The lowest flame setting is located adjacent to the OFF position.

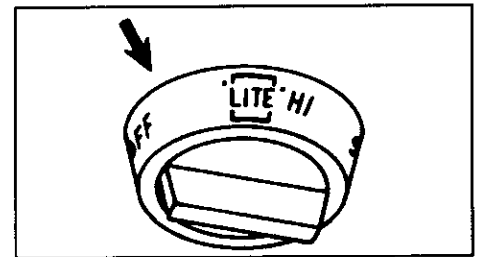

USING YOUR OVEN

OVEN DOOR

When opening oven door, allow steam and hot air to escape before reaching in oven to check, add or remove food.

To remove door: Open door to the "stop" position (opened about 4 inches) and grasp door with both hands at each side. Do not use door handle to lift door. Lift up evenly until door clears the hinge arms.

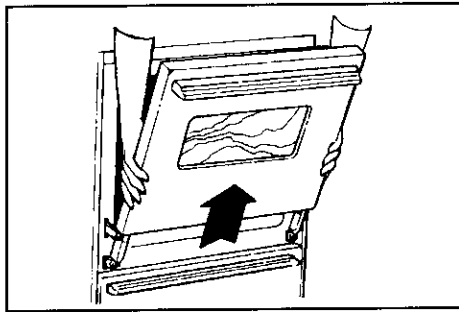

Do not attempt to open or close door until door is completely seated on hinge arms. Never turn on oven unless door is properly in place. When baking, be sure door is completely closed. Baking results will be affected if door is not securely closed.

IMPORTANT

DO NOT MOVE DOOR LOCK LEVER TO THE RIGHT DURING BROILING OR BAKING. If door lock lever is moved to the locked position, the cooking operation will automatically be cancelled and "door" will appear in the display.

OVEN BOTTOM

Protect oven bottom against excessive spillovers (especially acid or sugary spills). Use the correct size cooking utensil. Placing a sheet of aluminum foil, that is **slightly** larger than the cooking utensil, on the rack below the utensil will catch spills.

To remove: When cool, slide the two catches, located at each rear corner of the oven bottom, toward the front of the oven. Lift the rear edge of the oven bottom slightly, then slide it back until the holes in the front edge of the oven bottom clear the pins in the oven front frame. Remove oven bottom from oven.

CAUTION:

Hinge arms are spring mounted and will slam shut against the range if accidentally hit. **Never place hand or fingers between the hinges and the front oven frame.** You could be injured if hinge snaps back.

To replace door: Grasp door at each side, align slots in the door with the hinge arms and slide door down onto the hinge arms until completely seated on hinges.

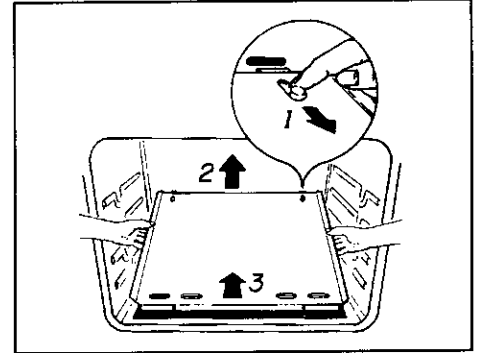

To replace: Fit holes onto pins, lower rear of oven bottom and slide the catches back to lock oven bottom into place.

STORAGE DRAWER

(if equipped)

The storage drawer at the bottom of the range is safe and convenient for storing metal and glass cookware. **DO NOT** store plastic, paperware, or food in this drawer. Remove drawer to clean under range.

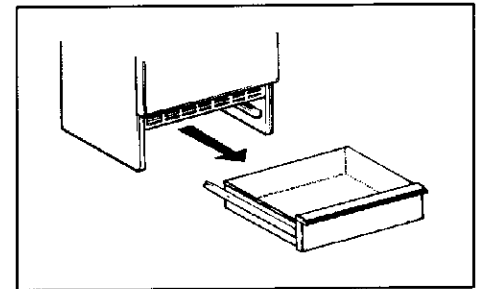

FAN

Slide-in range is equipped with a fan which automatically turns on whenever the oven is set for cooking or cleaning. The fan will automatically turn off when the oven cools to a preset temperature.

USING YOUR OVEN

OVEN CHARACTERISTICS

Every oven has its own characteristics. You may find that the cooking times and temperatures you were accustomed to with your previous range may need to be altered slightly with your new range. Please expect some differences with this new range.

PILOTLESS IGNITION

With this type of ignition system, the oven will not operate during a power failure or if unit is disconnected from the wall outlet. No attempt should be made to operate oven during a power failure.

OVEN BURNER

The size and appearance of a properly adjusted oven burner flame should be as shown:

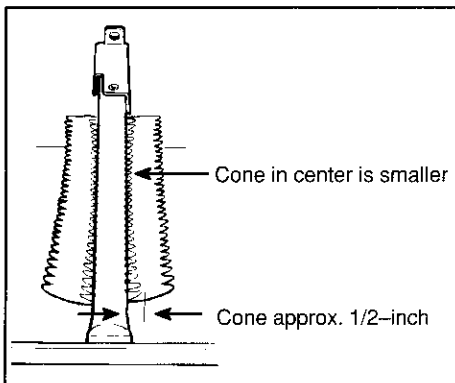

The oven temperature is maintained by cycling the burner on and off. After the oven temperature has been set, there will be about a 45 second delay before the burner ignites. This is normal, and no gas escapes during this delay.

During the clean cycle, and some extended oven cooking operations, you may hear a "popping" sound when the burner cycles off. This is a normal operating sound of the burner.

OVEN RACKS

The two oven racks are designed with a "lock-stop" position to keep racks from accidentally coming completely out of the oven.

To remove: Be sure rack is cool. Pull rack out to the "lock-stop" position. Tilt up and continue pulling until rack releases.

To replace: Place rack on rack supports, tilt up and push toward rear of oven. Pull rack out to "lock-stop" position to be sure rack is correctly replaced.

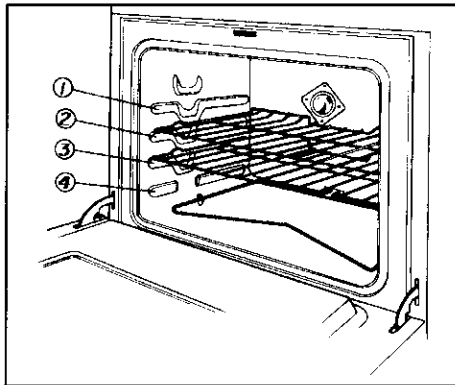

For optimum baking results, bake biscuits, cookies or cakes on one rack in the center of oven.

RACK POSITIONS:

RACK 1 (top of oven) used for broiling thin foods.

RACK 2 used for one-rack baking or broiling thicker cuts of meat.

RACK 3 used for most one-rack baking and for roasting some meats.

RACK 4 used for roasting large meats, cooking larger foods and for baking angel food cake or pie shells.

HINTS:

If cooking on two racks, stagger pans so one is not directly over the other. Use rack positions 1 and 3, 2 and 4, or 1 and 4, depending on baking results, when cooking on two racks.

Place food in the oven on the center of the rack. Allow 1 or 2 inches between edge of utensil and the oven sides or adjacent utensils.

PREHEATING

Preheating is necessary for baking. Allow oven to heat for 10 to 15 minutes before adding food. It is not necessary to preheat oven for roasting.

It is not necessary to preheat for broiling unless darker browning is desired or if cooking thin (3/4-inch) steaks. Allow burner to preheat 3 minutes.

Selecting temperature higher than desired will NOT preheat the oven any faster. Preheating at a higher temperature may have a negative effect on baking results.

To preheat: Set oven for baking and allow the oven to heat until display shows the preset temperature. 100 will appear in the display until the oven reaches 100°F. The display will then show the oven temperature in 5° increments until the oven reaches the preset temperature.

Once the preset temperature is reached, and the oven temperature has stabilized, a single beep will sound.

If the oven temperature is changed after preheating, a beep will signal that the oven has reached the new temperature setting.

USING YOUR OVEN

TO SET OVEN FOR BAKING OR ROASTING:

1. Press **BAKE TEMP** pad. "BAKE" indicator lights in the display.
2. Turn **SET** knob until desired temperature is displayed.
3. "BAKE ON" indicator and oven immediately turn on.

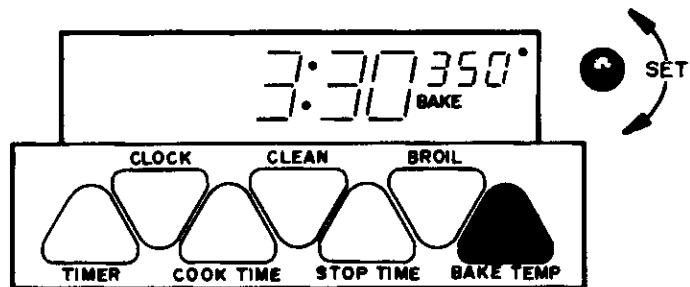

Preheat oven for all baking operations.

4. Place food in oven when oven has preheated to set temperature.
5. Check food at minimum time. Cook longer if necessary.
6. Press **STOP/CLEAR** pad to cancel the operation.

USING YOUR OVEN

COMMON BAKING PROBLEMS AND WHY THEY HAPPEN

PROBLEM	CAUSE	PROBLEM	CAUSE
<i>Cakes are uneven.</i>	Pans touching each other or oven walls. Batter uneven in pans. Temperature set too low or baking time too short. Oven not level. Undermixing. Too much liquid.	<i>Cakes don't brown on top.</i>	Incorrect rack position. Temperature set too low. Overmixing. Too much liquid. Pan size too large or too little batter in pan. Oven door opened too often.
<i>Cake high in middle.</i>	Temperature set too high. Baking time too long. Overmixing. Too much flour. Pans touching each other or oven walls. Incorrect rack position.	<i>Excessive shrinkage.</i>	Too little leavening. Overmixing. Pan too large. Temperature set too high. Baking time too long. Pans too close to each other or oven walls.
<i>Cake falls.</i>	Too much shortening or sugar. Too much or too little liquid. Temperature set too low. Old or too little baking powder. Pan too small. Oven door opened frequently. Added incorrect type of oil to cake mix. Added additional ingredients to cake mix or recipe.	<i>Uneven texture.</i>	Too much liquid. Undermixing. Temperature set too low. Baking time too short.
<i>Cakes, cookies, biscuits don't brown evenly.</i>	Incorrect rack position. Oven door not closed properly. Door gasket not sealing properly. Incorrect use of aluminum foil. Oven not preheated. Pans darkened, dented or warped.	<i>Cakes have tunnels.</i>	Not enough shortening. Too much baking powder. Overmixing or at too high a speed. Temperature set too high.
		<i>Cakes crack on top.</i>	Batter overmixed. Temperature set too high. Too much leavening. Incorrect rack position.
		<i>Cake not done in middle.</i>	Temperature set too high. Pan too small. Baking time too short.
			If additional ingredients were added to mix or recipe, expect cooking time to increase.
<i>Cakes, cookies, biscuits too brown on bottom.</i>	Oven not preheated. Pans touching each other or oven walls. Incorrect rack position. Incorrect use of aluminum foil. Placed 2 cookie sheets on one rack. Used glass, darkened, stained, warped or dull finish metal pans. (Use a shiny cookie sheet.)	<i>Pie crust edges too brown.</i>	Temperature set too high. Pans touching each other or oven walls. Edges of crust too thin.
		<i>Pies don't brown on bottom.</i>	Used shiny metal pans. Temperature set too low.
		<i>Pies have soaked crust.</i>	Temperature too low at start of baking. Filling too juicy. Used shiny metal pans.
			For optimum results, bake on one rack. If baking cakes on two racks, stagger pans so one is not directly over another.
			Follow cookware manufacturer's instructions for oven temperature. Glassware and dark cookware such as Ecco's Baker's Secret require lowering the oven temperature by 25° F.

USING YOUR OVEN

TO SET OVEN FOR BROILING:

See page 14 for complete broiling instructions.

1. Press BROIL pad. "BROIL" indicator lights in the display.

2. To set LO BROIL:

Turn SET knob clockwise ONE click to select LO broil for special lower temperature broiling operations. "LO BROIL" lights in the display.

To set HIGH BROIL:

Turn SET knob clockwise TWO clicks to select HIGH broil for normal broiling operations. "HI BROIL" lights in the display.

3. Close oven door. Cook food according to the Broil Chart on page 14. Check food at minimum time. Cook longer if necessary.

4. Press STOP/CLEAR pad to cancel broil operation.

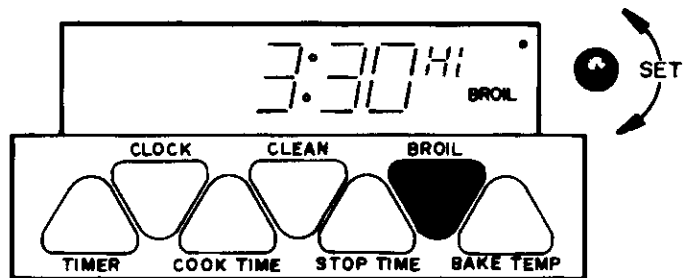
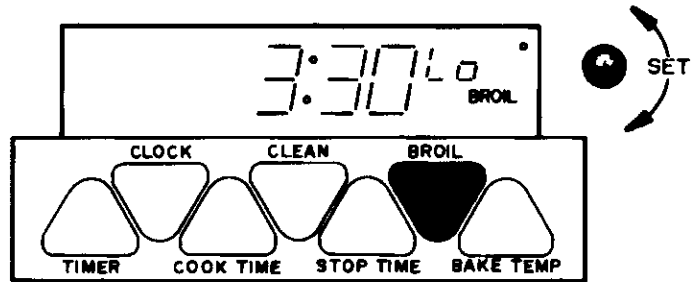

USING YOUR OVEN

HOW TO BROIL

Broiling is a method of cooking tender meats by direct heat under the burner. The cooking time is determined by the distance between the meat and the burner, the desired degree of doneness and the thickness of the meat.

Broiling requires the use of the broiler pan and insert. The correct position of the insert in the pan is very important. The broiler insert should be placed in the pan so grease will drain freely. Improper use may cause grease fires.

The broiler insert CANNOT be covered with aluminum foil as this prevents fat

from draining into pan below. However, for easier cleaning, the broiler pan can be lined with foil.

Do not use disposable broiler pans. They do not provide a separate tray.

TO BROIL:

1. Prepare meat by removing excess fat and slashing remaining fat, being careful not to cut into meat. This will help keep meat from curling.
2. Place broiler pan on any of the recommended rack positions. Generally, for brown exterior and rare interior, the meat should be close to the burner. Place further down if you want meat well done.

3. Broiling should be done with oven door closed.

4. Follow suggested times on broiling chart. Meat should be turned once about half way through cooking.

5. Check doneness by cutting a slit in meat near center for desired color.

6. Press STOP/CLEAR pad to cancel a broil operation.

Use HI BROIL for most broil operations. When broiling longer cooking foods such as pork chops, poultry or thick steaks, select LO BROIL. Low temperature broiling allows food to cook to the well done stage without excessive browning. Cooking time may increase if LO BROIL is selected.

BROILING CHART

TYPE OF FOOD	RACK POSITION	DONENESS	TOTAL TIME
BACON	#2	Well Done	6 to 10 minutes
BEEF STEAKS 1-inch thick 1 1/2-inch thick	#2	Rare	10 to 14 minutes
	#2	Medium	15 to 18 minutes
	#2	Well Done	19 to 22 minutes
	#2	Rare	18 to 20 minutes
	#2	Medium	22 to 24 minutes
	#3	Well Done	25 to 30 minutes
CHICKEN Whole, split Pieces	#3	Well Done	LO BROIL 45 to 60 minutes
	#3	Well Done	30 to 45 minutes
FISH STEAK OR FILLET 1/2-inch thick	#2	Flaky	10 to 12 minutes
GROUND BEEF PATTIES 3/4 to 1-inch thick	#2	Rare	10 to 13 minutes
		Medium	12 to 15 minutes
		Well Done	15 to 18 minutes
HAM SLICE , precooked 1-inch thick 1 1/2-inch thick	#2		12 to 16 minutes
	#2		21 to 26 minutes
LAMB CHOPS 1-inch thick 1 1/2-inch thick	#2	Medium	12 to 15 minutes
		Well Done	16 to 20 minutes
	#3	Medium	15 to 19 minutes
		Well Done	25 to 30 minutes
PORK CHOPS 3/4-inch thick 1-inch thick	#2	Well Done	15 to 20 minutes
	#2	Well Done	20 to 25 minutes
WIENERS , precooked Hot dogs, smoked or Polish sausage, Bratwurst, etc.	#2		8 to 12 minutes
BREADS Toast Toaster Pastries English Muffins, buttered	#2		TIME PER SIDE 5 to 8 minutes/side
	#2		5 to 8 minutes/side
	#2		5 minutes

MAINTENANCE

ELECTRICAL CONNECTION

Appliances which require electrical power are equipped with a three-prong grounding plug which must be plugged directly into a properly grounded three-hole 120 volt electrical outlet.

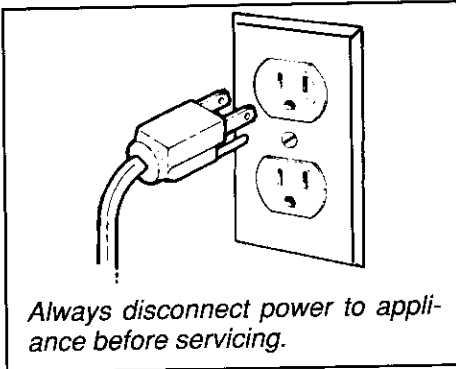

If an ungrounded, two-hole or other type electrical outlet is encountered, IT IS THE PERSONAL RESPONSIBILITY OF THE APPLIANCE OWNER TO HAVE RECEPTACLE REPLACED WITH A PROPERLY GROUNDED THREE HOLE ELECTRICAL OUTLET. The three-prong grounding plug is provided for protection against shock hazards. **DO NOT CUT OR REMOVE THE THIRD GROUNDING PRONG FROM THE POWER CORD PLUG.**

HOW TO REMOVE RANGE FOR CLEANING AND SERVICING

When necessary, follow these procedures to remove appliance for cleaning or servicing:

1. Shut-off gas supply to appliance.

2. Disconnect electrical supply to appliance.
3. Disconnect gas supply tubing to appliance.
4. Slide range forward to disengage range from the anti-tip bracket. (See Installation Instructions for location of bracket.)
5. Drop-in ranges, wall ovens and cooktops: Remove screws that secure appliance to cabinet. Remove appliance from cabinet.
6. Reverse procedure to reinstall. If gas line has been disconnected, check for gas leaks after reconnection. (See Installation Instructions for gas leak test method.) Note: A trained serviceman should make the gas installation, disconnection, and re-connection of gas supply to the appliance.

ANTI-TIP BRACKET

To prevent range from accidentally tipping, range should be secured to the floor by sliding rear leveling leg into an anti-tip bracket supplied with the range.

OVEN LIGHT REPLACEMENT

Before replacing oven light bulb, **DISCONNECT POWER TO RANGE.** Be sure bulb and range parts are cool. Do not touch a hot bulb with a damp cloth as the bulb may break.

To replace oven light: Self-clean oven models only. Remove 4 screws and plates as illustrated below. Use care when removing gasket, it may tear. Replace with a 40 watt appliance bulb. (Not covered by warranty). Reconnect power to range and reset clock.

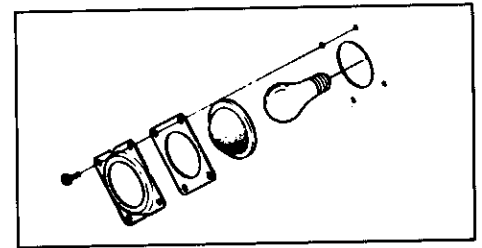

BACKGUARD LIGHT

To turn on backguard light, press and hold "cooktop" rocker switch, located on backguard, until light turns on.

To replace fluorescent surface light: Disconnect power to range. Grasp the top trim of backguard with thumbs under front edge and pull outward while lifting to release trim from catches at each end.

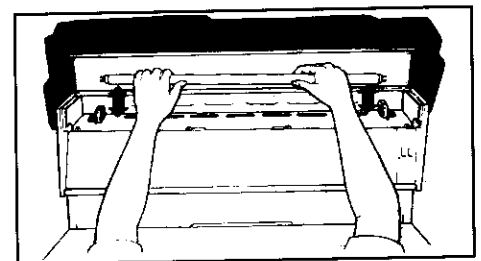

Remove bulb and replace with an 18 watt fluorescent tube. Snap top trim back into place, restore power, and reset clock.

MAINTENANCE

LEVELING LEGS

Some floors are not level. For proper baking, your range must be level. Leveling legs are located on each corner of the base of the range. Place a level horizontally on an oven rack and check front-to-back and side-to-side. Level by turning the legs.

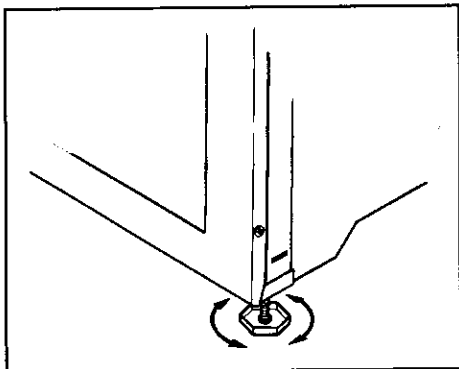

PROPORTIONAL VALVE ADJUSTMENT (if equipped)

The LOW setting should produce a stable flame when turning the knob from HI to LOW. The flame should be 1/8 inch or lower and must be stable on all ports on LOW setting.

To adjust: Operate burner on HI for about 5 minutes to preheat burner cap. Turn knob back to LOW; remove knob, and insert a small screwdriver into the center of the valve stem. Adjust flame size by turning adjustment screw in either direction. Flame must be of sufficient size to be stable on all burner ports. If flame adjustment is needed, adjust **ONLY** on the LOW setting. Never adjust flame size on a higher setting.

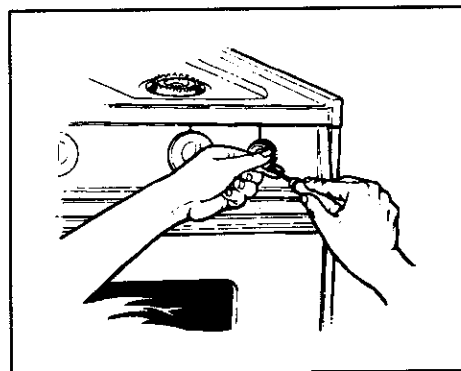

NOTE: All gas adjustments should be done by a qualified servicer only.

CARE AND CLEANING

PARTS	CLEANING AGENTS	DIRECTIONS Be sure all parts are cool before cleaning. Be sure all parts are properly replaced after cleaning.
Baked Enamel Side panels Backguard Oven door Broiler drawer	Soap & water. Paste of baking soda & water.	Use a dry towel or cloth to wipe up spills, especially acid spills, as soon as they occur. (This is especially important for white surfaces.) When surface is cool, wash with soap and water. Do not use abrasive or harsh cleaning liquids and powders or oven cleaners. These will scratch and permanently damage the finish. Dry with a soft cloth.
Broiler pan & insert	Soap & water. Plastic scouring pad. Soap filled scouring pad.	Remove from oven after use. Cool then pour off grease. Place soapy cloth over insert and pan; let soak to loosen soil. Wash in warm soapy water. Use soap filled scouring pad to remove stubborn soil. Clean in dishwasher if desired.
Burner box	Soap & water.	Burner box, located under lift-up cooktop, should be cleaned frequently to remove spillovers. If soil is not removed and is allowed to accumulate, it may damage the finish. To clean, remove surface burners and clean with soap and water, rinse and dry. NOTE: Cooktop on sealed burner models does not lift up.
Chrome drip bowls, if equipped	Soap & water. Paste of baking soda & water. Plastic scouring pad.	Clean bowls after each use with soap and water. Remove stubborn stains with baking soda paste and plastic scouring pad. To prevent scratching the finish, do not use abrasive cleaning agents. Rinse, dry and replace. NOTE: Bowls can permanently discolor if exposed to excessive heat or if soil is allowed to bake on.
Control knobs	Soap & water.	To remove knobs for cleaning, gently pull forward. Wash in mild detergent and water. Do not use abrasive cleaning agents. They will scratch finish and remove markings. Rinse, dry and replace. Turn each burner ON to see if knobs have been replaced correctly.
Glass Backguard Oven window	Soap & water. Paste of baking soda & water. Window cleaning fluid.	Wash with soap and water. Remove stubborn soil with paste of baking soda and water. To avoid inside staining of oven door glass, do not oversaturate cloth. Do not use abrasive materials such as scouring pads, steel wool or powdered cleaning agents. They will damage glass. Rinse with clear water and dry.
Grates	Paste of baking soda and water, scouring powder, detergent & water. Soap filled scouring pad.	Grates are made of porcelain coated steel. They can be cleaned at the sink with detergent and water or in the dishwasher. Clean stubborn soil with soap filled scouring pad.
Metal finishes Backguard Trim parts Manifold panel	Soap & water. Paste of baking soda & water.	Wash with soap and water. Remove stubborn soil with paste of baking soda and water. Do not use oven cleaners, abrasive or caustic agents. They will damage the finish.
Oven racks	Soap & water. Cleansing powders & plastic pads. Soap filled scouring pad.	Clean with soapy water. Remove stubborn soil with cleansing powder or soap filled scouring pad. Rinse and dry.
Plastic or vinyl finishes Door handles Backguard trim Overlays Knobs End caps	Soap & water. Paste of baking soda & water. Non-abrasive plastic pad or sponge.	Never use oven cleaners, abrasive or caustic liquid or powdered cleaning agents on plastic finishes. These cleaning agents will scratch or mar finish. To prevent staining or discoloration, wipe up fat, grease or acid (tomato, lemon, vinegar, milk, fruit juice, marinade) immediately with a dry paper towel or cloth. When surface is cool, clean with soap and water; rinse, and dry.
Porcelain finish Cooktop	Soap & water. Paste of baking soda & water. Non-abrasive plastic pad or sponge.	Porcelain enamel is glass fused on metal. It may crack or chip with misuse. Clean with soap and water when parts are cool. All spillovers, especially acid or sugar spillovers, should be wiped up immediately with a dry cloth. Surface may discolor or dull if soil is not removed. When surface is cool, clean with warm soapy water. NEVER WIPE OFF A WARM OR HOT ENAMEL SURFACE WITH A DAMP CLOTH. THIS MAY CAUSE CRACKING AND CHIPPING. Never use abrasive or caustic cleaning agents on exterior finish of range. Cooktop on sealed surface burner models does NOT lift up.
Porcelain finish interior (See page 5 for self-clean oven.)	Soap & water. Cleansing powders & plastic pads.	Clean oven interior with soap and water. Use cleansing powders or a plastic scouring pad to remove stubborn soil. Wipe acid or sugar stains as soon as the oven is cool as these stains may discolor or etch the porcelain. Do not use metallic scouring pads as they will scratch the porcelain. Commercial oven cleaners can NOT be used on the self-clean oven.
Silicone rubber Door gasket		Do not clean gasket on self-clean oven frame.
Surface burners Uniburner, Single burner	Soap & water. Paste of baking soda & water. Plastic scouring sponge or pad.	Clean as necessary with warm soapy water. Remove stubborn soil by scouring with a non-abrasive plastic scouring pad and a paste of baking soda and water. Clean ports with a straight pin. Do not enlarge or distort the ports. Do not use a wooden toothpick. It may break off and clog port. DO NOT CLEAN BURNERS WITH THE FOLLOWING caustic cleaners: oven cleaners, steel wool or abrasive cleaning agents. These may damage finish. Burners can be dried in the oven set at 140°F. CAUTION: Burner and burner tube must be dry before use.

SERVICE

BEFORE CALLING A SERVICE TECHNICIAN, CHECK THE FOLLOWING:

PROBLEM	CAUSE	CORRECTION
1. Burner flame uneven.	a. clogged burner port(s).	a. clean ports with straight pin. Be sure ignitors are not sparking.
2. Burner fails to light.	a. power supply not connected. b. controller incorrectly set.	a. connect power, check circuit breaker or fuse box. Oven will not operate during a power failure. b. see page 4.
3. Oven temperature inaccurate. • food takes too long or cooks too fast. • pale browning. • food over-done on outside and under-done in center. • over browning.	a. oven not preheated. b. incorrect rack position. c. incorrect use of foil. d. oven bottom incorrectly replaced. e. oven thermostat sensing device out of holding clip(s).	a. preheat oven 10 minutes. b. see page 10. c. see page 10. d. replace oven bottom correctly see page 9. e. reinsert sensing device securely into clip(s).
4. Clock and/or light do not work.	a. power supply not connected. b. burned out light bulb. c. malfunctioning switch. d. malfunctioning clock or loose wiring.	a. connect power supply, check circuit breaker or fuse box. b. replace light bulb. c. call serviceman to check. d. call serviceman to check.
5. Surface burner flame • lifts off port • yellow in color	a. air/gas mixture not proper	a. call serviceman to adjust burner primary air
F plus a number appears in the display and a continuous beep sounds. (Example: F 1)	This is called a FAULT CODE. If a fault code appears in the display, press the STOP/CLEAR pad. If the fault code reappears, disconnect power to the unit and call the servicer. See page 4 for operating instructions.	

SERVICE

Do not attempt to service the appliance yourself unless directed to do so in this book. Contact the dealer who sold you the appliance for service.

cover for location of your model and serial numbers.)

If you are unable to obtain service, write to us. Our address is found on the rating plate. See front cover for location of rating plate.

If you did not receive satisfactory service through your servicer or Maycor you may contact the Major Appliance Consumer Action Panel by letter including your name, address, and telephone number, as well as the model and serial numbers of the appliance.

HOW TO OBTAIN SERVICE

When your appliance requires service or replacement parts, contact your Dealer or Authorized Servicer. Use only genuine factory or Maycor parts if replacement parts are necessary. Consult the Yellow Pages in your telephone directory under appliance for the service center nearest you. Be sure to include your name, address, and phone number, along with the model and serial numbers of the appliance. (See front

If you are not satisfied with the local response to your service requirements, call or write MAYCOR Appliance Parts and Service Company, 240 Edwards Street, S.E., Cleveland, TN 37311, (615) 472-3500. Include or have available the complete model and serial numbers of the appliance, the name and address of the dealer from whom you purchased the appliance, the date of purchase and details concerning your problem.

Major Appliance Consumer Action Panel
20 North Wacker Drive
Chicago, IL 60606

MACAP (Major Appliance Consumer Action Panel) is an independent agency sponsored by three trade associations as a court of appeals on consumer complaints which have not been resolved satisfactorily within a reasonable period of time.

FULL ONE-YEAR WARRANTY

DOMESTIC GAS OR ELECTRIC RANGE

Maycor Appliance Parts & Service Company will repair or replace, without charge, any part of your product which has a defect in material or workmanship during the first year after the date of the original installation. This warranty extends to any owner during the one-year warranty period.

LIMITED 5 YEAR WARRANTY

On electric ranges equipped with solid disc or smoothtop heating elements, and on gas ranges with sealed burners, for an additional 4 year period beyond the first year of the general coverage of this warranty, Maycor will replace any of the solid disc or smoothtop heating elements, or sealed burners which fail to heat as a result of defective workmanship or material. Additionally, Maycor will replace any smoothtop cooking surface which cracks or breaks during normal household cooking. These parts must be installed by a qualified person. Any labor charge required for replacement is not covered by this warranty.

HOW TO OBTAIN SERVICE

To obtain the repair or replacement of a defective part under these warranties, you should contact the dealer from whom you purchased the appliance or a servicer he designates.

WHAT IS NOT COVERED BY THESE WARRANTIES

1. Conditions and damage resulting from improper installation, delivery, unauthorized repair, modification, or damage not attributable to a defect in material or workmanship.
2. Conditions resulting from damage, such as: (1) improper maintenance, (b) misuse, abuse, accident, or (c) incorrect electrical current or voltage.
3. Warranties are void if the original serial number has been removed, altered, or cannot be readily determined.
4. Light bulbs.
5. Any product used for other than normal household use. It does not extend to products purchased for commercial or industrial use.
6. Any expense incurred for service calls to correct installation errors or to instruct you on how to use the products.
7. CONSEQUENTIAL OR INCIDENTAL DAMAGES SUSTAINED BY ANY PERSON AS A RESULT OF ANY BREACH OF THESE WARRANTIES OR ANY IMPLIED WARRANTY. Some states do not allow the exclusion or limitation of consequential or incidental damages, so the above exclusion may not apply to you.

ADDITIONAL HELP

If you are not satisfied with the local response to your service requirements and wish to contact Maycor, please address your letter to the Customer Relations Department, Maycor Parts & Service Company, 240 Edwards Street, S.E., Cleveland, TN 37311 or call (615) 472-3500. To save time, your letter should include the complete model and serial numbers of the warranted appliance, the name and address of the dealer from whom you purchased the appliance, the date of purchase and details concerning your problem.

These warranties are the only written or expressed warranties given by Maycor. No one is authorized to increase, alter, or enlarge Maycor's responsibilities or obligations under these warranties. These warranties give you specific legal rights, and you may also have other rights which vary from state to state.

8109P059-60
(6/91)