

USER'S GUIDE

TABLE OF CONTENTS

Welcome	Inside Cover
Safety Instructions	1-2
Washer Controls At A Glance	3-5
Washer Features	6-10
Replacing the Washer Light	11
Reversing the Clothes Washer Door	11
Dryer Controls At A Glance	12-13
Dryer Operating Tips	14
Dryer Exhaust Tips	15
Replacing the Drum Light ...	16
Reversing the Dryer Door ...	16
Water Use	17
Care and Cleaning	17
Storing the Neptune™ Super Stack	17
Washer Operating Sounds	18
Before You Call	19-21
Warranty	Back Page



NEPTUNE™



Dryer Model: MUG2000, MUE2000

Washer Model: MHW2000

Welcome.....



Welcome and congratulations on your purchase of a Maytag Neptune™ Super Stack! Your complete satisfaction is very important to us.

Read this manual for best results. It contains instructions to acquaint you with proper operating and maintenance procedures.

In addition you will find a *Laundering Tips* guide packed with your washer. It contains information on recommended laundering procedures, stain removal and special laundering situations.



Save time and money. If something should go wrong, we suggest consulting the "Before You Call" section in the back of this book. It is designed to help you solve basic problems before consulting a servicer.

However, should you need assistance in the future, it is helpful to:

1) Have complete model and serial number identification of your washer and dryer. Record these numbers below for easy access.

2) Have proof of original date of purchase.

Please attach your sales receipt here. Keep this information for your records (should you ever need warranty service).

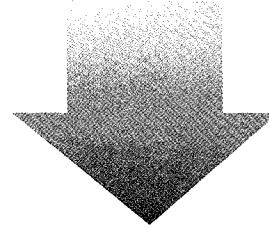

For additional questions, please contact us:

Maytag Appliances Sales Company
Attn: CAIRSM Center
P.O. Box 2370
Cleveland, TN 37320-2370
1-888-462-9824 USA & CANADA
1-800-688-2080 TTY USA
(Mon.-Fri., 8am-8pm Eastern Time)
Internet: <http://www.maytag.com>

For service and warranty information, see back page.

NOTE: *In our continuing effort to improve the quality of our appliances, it may be necessary to make changes to the stacked washer and dryer without revising this guide.*

Dryer Model Number

Dryer Serial Number

Washer Model Number

Washer Serial Number

Dryer Model
and Serial
Number Location



Washer Model
and Serial
Number Location

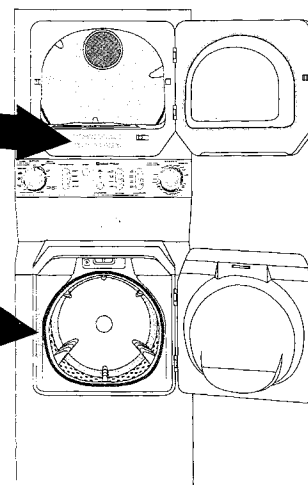

Important Safety Notice and Instructions.....

The California Safe Drinking Water and Toxic Enforcement Act of 1986 (Proposition 65) requires the Governor of California to publish a list of substances known to the State of California to cause cancer or reproductive harm, and requires businesses to warn customers of potential exposures to such substances.

Users of this appliance are hereby warned that the burning of gas can result in low-level exposure to some of the listed substances, including benzene, formaldehyde and soot, due primarily to the incomplete combustion of natural gas or liquid petroleum (LP) fuels. Exhaust ducts should be kept free of obstructions and properly exhausted dryers will minimize exposure.

Appliances with the  symbol on the data plate have been listed with Underwriters' Laboratories, Inc. Those with a CSA Monogram on the data plate have been certified by the CSA Testing Laboratories as complying with Canadian Standards Association requirements. Gas dryers with an AGA symbol on the data plate have been design certified with the American Gas Association; those with a CGA symbol on the data plate have been approved by the Canadian Gas Association. Nevertheless, as with any equipment using electricity and having moving parts, there are potential hazards. To use this appliance safely, the operator should become familiar with the instructions for operation of the appliance and always exercise care when using it.

⚠ WARNING — For your safety the information in this manual must be followed to minimize the risk of fire or explosion or to prevent property damage, personal injury or death.

- Do not store or use gasoline or other flammable vapors and liquids in the vicinity of this or any other appliance.
- **WHAT TO DO IF YOU SMELL GAS**
 - Do not try to light any appliance.
 - Do not touch any electrical switch; do not use any phone in your building.
 - Clear the room, building or area of all occupants.
 - Immediately call your gas supplier from a neighbor's phone. Follow the gas supplier's instructions.
 - If you cannot reach your gas supplier, call the fire department.

Installation and service must be performed by a qualified installer, service agency or the gas supplier.

⚠ WARNING — Do not place into your dryer items that have been spotted or soaked with vegetable oil or cooking oil. Even after being washed, these items may contain significant amounts of these oils. The remaining oil can ignite spontaneously. The potential for spontaneous ignition increases when the items containing vegetable oil or cooking oil are exposed to heat. Heat sources, such as your clothes dryer, can warm these items, allowing an oxidation reaction in the oil to occur. Oxidation creates heat. If this heat cannot escape, the items can become hot enough to catch fire. Piling, stacking or storing these kinds of items may prevent heat from escaping and can create a fire hazard.

All washed and unwashed fabrics that contain vegetable oil or cooking oil can be dangerous. Washing these items in hot water with extra detergent will reduce, but will not eliminate, the hazard. Always use the "cool down" cycle for these items to reduce the items' temperature. Never remove these items from the clothes dryer while hot or interrupt the drying cycle until the items have run through the "cool down" cycle. Never pile or stack these items when they are hot.

Save These Instructions

Important Safety Instructions

⚠ WARNING — To reduce the risk of fire, explosion, electric shock, property damage or injury to persons when using your appliance, follow basic precautions, including the following:

1. Read all instructions before using the appliance.
2. To avoid the possibility of fire or explosion:
 - a. Do not wash or dry items that have been previously cleaned in, washed in, soaked in, or spotted with gasoline, dry-cleaning solvents, other flammable or explosive substances as they give off vapors that could ignite or explode. Hand wash and line dry any items containing these substances.

Any material on which you have used a cleaning solvent, or which is saturated with flammable liquids or solids, should not be placed in the appliance until all traces of these liquids or solids and their fumes have been removed.

These items include acetone, denatured alcohol, gasoline, kerosene, some liquid household cleaners, some spot removers, turpentine, waxes and wax removers.
 - b. Do not add gasoline, dry-cleaning solvents, or other flammable or explosive substances to the wash water. These substances give off vapors that could ignite or explode.
 - c. Under certain conditions, hydrogen gas may be produced in a hot water system that has not been used for 2 weeks or more. **HYDROGEN GAS IS EXPLOSIVE.** If the hot water system has not been used for such a period, before using a washing machine or combination washer-dryer, turn on all hot water faucets and let the water flow from each for several minutes. This will release any accumulated hydrogen gas. As the gas is flammable, do not smoke or use an open flame during this time.
 - d. Items containing foam rubber (may be labeled latex foam) or similarly textured rubber-like materials must not be dried on a heat setting. Foam rubber materials when heated, can under certain circumstances produce fire by spontaneous combustion.
 - e. Do not place items exposed to cooking oils in your dryer. Items contaminated with cooking oils may contribute to a chemical reaction that could cause a load to catch fire.
3. Do not allow children to play on or in the appliance. Close supervision of children is necessary when the appliance is used near children.
4. Before the appliance is removed from service or discarded, remove the door to the clothes washer and clothes dryer compartment.
5. Do not reach into the appliance if the tub or drum is moving.
6. Do not install or store this appliance where it will be exposed to the weather.
7. Do not tamper with controls.
8. Do not repair or replace any part of the appliance or attempt any servicing unless specifically recommended in published user-repair instructions that you understand and have the skills to carry out.
9. Do not use fabric softeners or products to eliminate static unless recommended by the manufacturer of the fabric softener or product.
10. Clean the dryer lint screen before or after each load.
11. Keep the area around the exhaust opening and surrounding areas free from lint accumulation, dust and dirt.
12. The interior of the dryer and exhaust duct should be cleaned yearly by qualified service personnel.
13. This appliance must be properly grounded. Never plug the appliance cord into a receptacle which is not grounded adequately and in accordance with local and national codes. See Installation Instructions for grounding this appliance.
14. Unplug power supply cord before attempting to service your appliance.
15. Store laundry aids and other material in a cool, dry place where children cannot reach them.
16. Do not use chlorine bleach and ammonia or acids (such as vinegar or rust remover) in the same wash. Hazardous fumes can form.
17. Do not machine wash fiberglass materials. Small particles can stick to fabrics washed in following loads and cause skin irritation.
18. Install and level washer on a floor that can support the weight.
19. As with any equipment using electricity and having moving parts, there are potential hazards. To use this appliance safely, the operator should become familiar with the instructions for operation of the appliance and always exercise care when using it.

Save These Instructions



Washer Controls At A Glance

Step 1 Select Wash/Rinse Water Temperatures

Press the appropriate button to select the wash and rinse water temperatures. Follow the garment care label for best results. Use the chart below as a guide.

WASH/RINSE TEMPS	LOAD TYPE
Hot/Cold	White and heavily soiled, color-fast items
Warm/Warm	Some delicate and color-fast items
Warm/Cold	Moderately soiled, colored items; most Easy Care/Permanent Press items
Cold/Cold	Brightly colored, lightly soiled items; washable woolens

REMEMBER: In wash water temperatures below 65° F, detergents do not dissolve well or clean well. Care labels define cold water as up to 85° F.

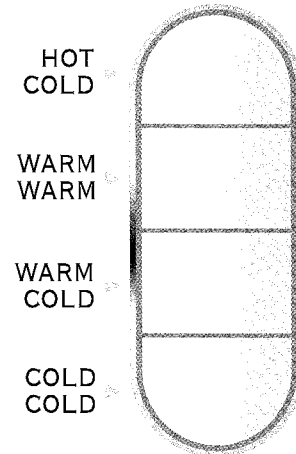

WASH/RINSE

Step 2 Select Options (if desired)

Press the appropriate button(s) to select one or more options.

OPTION	USE
Max Extract	Removes more water from a load during spin. Use for jeans, towels and bedding.
Extra Rinse	Provides an additional rinse near the end of the cycle to more completely remove laundry additives, perfumes, etc.
Signal	Provides an audible signal upon the completion of a cycle.
Reset	Cancels any or all previously selected options.

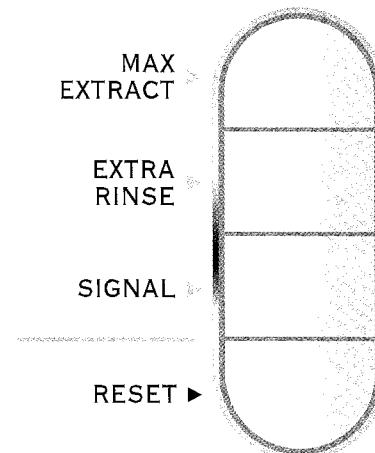

OPTIONS

Step 3 Select Cycle

Rotate the control dial clockwise to the desired cycle. The triangle symbol, ▲, is the appropriate setting for the majority of loads for most effective cleaning.

EASY CARE/PERMANENT PRESS –

Designed to minimize wrinkling and tangling by using a slightly reduced tumble pattern and decreased spin speed.

Load Type: Dress shirts, dress pants, poly/cotton blend clothing.

HEAVY– Used for cleaning heavily soiled loads. Approx. cycle time 45 min.

▲ – Used for most loads. Approximately 37 minutes to complete the cycle.

LIGHT – Used for cleaning lightly soiled loads. Approx. cycle time 32 min.

REGULAR – Designed for durable items. Tumbles more often and has a greater spin speed for better water extraction.

Load Type: Jeans, towels, bedding.

PREWASH – Extends the wash time by 9 minutes to clean very heavily soiled loads. Add 1 1/2 times the amount of detergent.

HEAVY– Used for cleaning heavily soiled loads. Approx. cycle time 46 min.

▲ – Used for most loads. Approximately 40 minutes to complete the cycle.

LIGHT – Used for cleaning lightly soiled loads. Approx. cycle time 35 min.

EASY CARE /
PERM PRESS

REGULAR

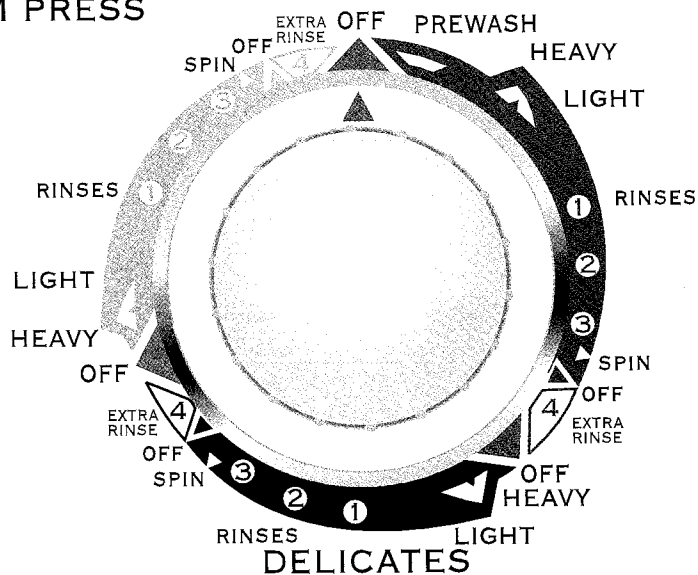

DELICATES – Offers a gentle tumble and long pause to properly handle these items. Although there is a reduced spin speed, water extraction is appropriate.

Load Type: Dress skirts/blouses, nylons, sheer or lacy garments.

HEAVY– Used for cleaning heavily soiled loads. Approx. cycle time 45 min.

▲ – Used for most loads. Approximately 40 minutes to complete the cycle.

LIGHT – Used for cleaning lightly soiled loads. Approx. cycle time 34 min.

The controls for the stacked washer and dryer are convenient and easy to use. The washer and dryer can operate at the same time or independently of each other.

For detailed information on sorting, pretreating stains, etc., see the enclosed Laundering Tips pamphlet.

Step 4 Load the Clothes Washer

- The tub can be loaded completely full with dry unfolded clothes. However, do not pack the tub tightly.
- Overloading may reduce washing efficiency and possibly cause creasing or wrinkling of the load.
- When washing big bulky items, such as a rug, that do not fill the tub completely, a few towels may be added for best performance.
- **To load a forgotten item immediately after the clothes washer has started, press the START/STOP button.** The door will remain unlocked for approximately 3 minutes into the start of the cycle. Add the item(s), close the door and press the START/STOP button to resume the cycle.
- **Once the door has locked, it is possible to load a forgotten item.** Press the START/STOP button and wait approximately 2 minutes for the “Door Locked” indicator to turn off. Open the door, add the item(s), close the door and press the START/STOP button to resume the cycle.
- Add laundry detergent on top of the load in the tub and additives to the dispensers (See Detergent page 6).

Step 5 Start Your Maytag Neptune™ Washer

- Close the washer door.
- Push the **START/STOP** button.
- The washer has started when the ON light is lit and an audible tone is heard.

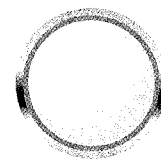

START/STOP

The wash cycle is complete when the control dial points to “OFF” and the “Door Locked” light is no longer lit. The door should open easily.

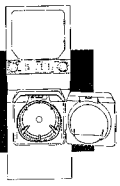

Washer Features.....

Detergent

Your Maytag Neptune™ stacked washer is designed to use a high efficiency laundry detergent or laundry detergent normally used with top loading washers.

- For best cleaning results, use a high efficiency detergent specially formulated for front load washers such as Tide HE or Wisk*. To identify this type of detergent, look for the High Efficiency symbol shown to the right.
- If you are unable to locate the High Efficiency laundry detergent products in your area, you will achieve successful cleaning results with laundry detergent normally used in top loading washers.



Adding Detergent

Either liquid or granular detergent may be used to wash clothes. Follow the directions on the box or bottle to determine the appropriate amount of detergent. Pour the detergent directly on top of the load in the tub.

If color-safe bleach is to be used, it should be added on top of the load with detergent for best results.

If using the "PREWASH" setting, measure 1 1/2 times the amount of detergent.



Automatic Dispenser

There are two automatic dispensing compartments. One holds liquid chlorine bleach and the other holds liquid fabric softener. The laundry additives can be added to their respective dispenser compartments. They will be dispensed at the appropriate time for the most effective cleaning and softening.

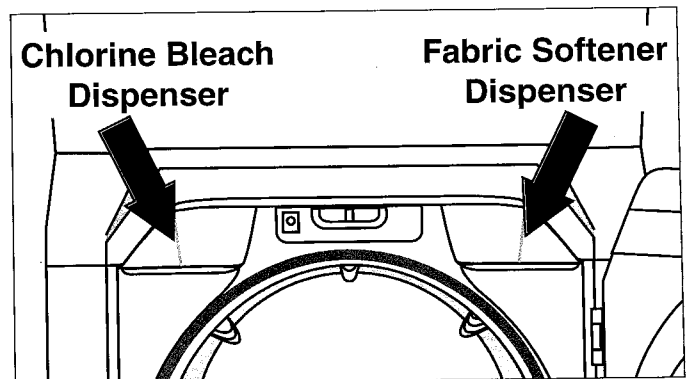

**Brand names are trademarks of the respective manufacturer.*

Adding Chlorine Bleach

The dispenser automatically dilutes liquid chlorine bleach before it reaches the wash load. Follow these steps when using liquid chlorine bleach:

1. Add liquid chlorine bleach to the chlorine bleach compartment but do not exceed the **MAX FILL 3/4 CUP** line. The chlorine bleach compartment will hold 3/4 of a cup.
2. Avoid splashing or over-filling the compartment. **Over-filling the compartment will release the chlorine bleach into the clothes washer too early.**

NOTE:

- Never pour undiluted liquid chlorine bleach directly onto the load or into the tub. It is a powerful chemical and can cause fabric damage, such as weakening of the fibers or color loss, if not used properly.
- If you prefer to use color-safe, non-chlorine bleach, add it with the detergent. **Do not pour color-safe bleach into the liquid chlorine bleach compartment.**

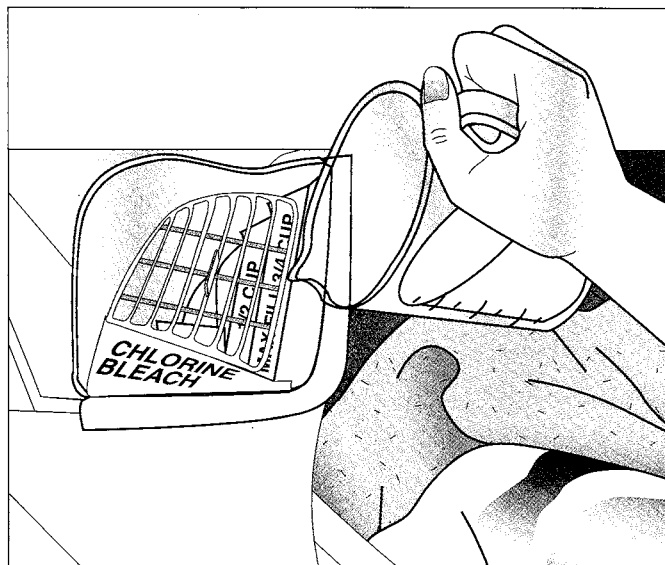

Adding Fabric Softener

This compartment automatically dilutes and releases liquid fabric softener at the proper time during the cycle. Follow these steps when using liquid fabric softener:

1. Pour liquid fabric softener into the fabric softener compartment using the amount recommended on the package.
2. Fabric softener may be diluted with warm water until it reaches the **MAX FILL DILUTED** line on the compartment. **Do not fill the liquid fabric softener compartment above the MAX FILL DILUTED line. If the compartment is filled above the MAX FILL DILUTED line, it will enter the clothes washer too early.**

NOTE:

- Never pour fabric softener directly on the load. It may leave spots and stains.
- Use the fabric softener compartment only for liquid fabric softeners.
- Using the Downy Ball* is not recommended with this washer. It will be ineffective in reducing static cling and providing softness.

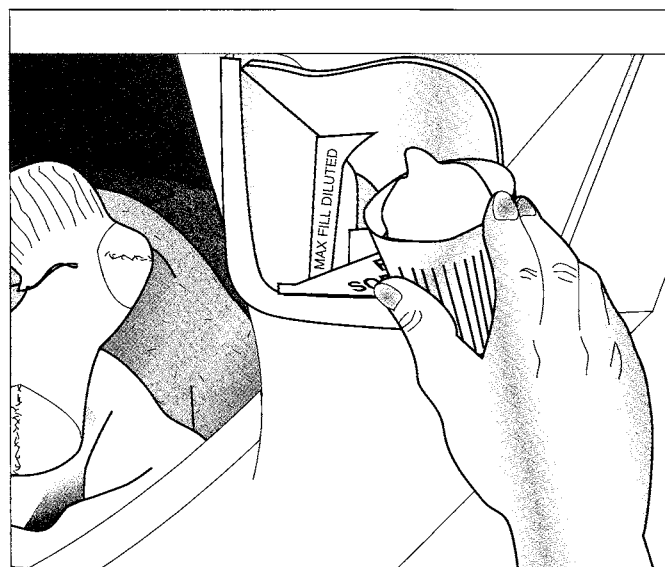

Cleaning the Dispensers

The dispensers may need to be cleaned periodically due to laundry additive build-up. For easy clean-up of the dispenser, follow the directions for the corresponding dispenser.

Removing the Chlorine Bleach Dispenser

1. Grasp the corner lip of the chlorine bleach dispenser. Lift the dispenser up and tip it to the right to avoid hitting the washer frame. (Illustration #1)
2. Under the chlorine bleach dispenser in the dispensing compartment is an overflow grate. Grasp the overflow grate by the word "CAUTION" and pull it up and out of the dispensing compartment. (Illustration #2)
3. Take the bleach dispenser and the overflow grate to the sink. Be careful, there may be chlorine bleach left in the dispenser. Lift the gray siphon cap out of the chlorine bleach dispenser. (Illustration #3)
4. Run warm water over the dispenser, gray siphon cap and overflow grate to remove any build-up. A soft cloth may be used for stubborn stains.

Replacing the Chlorine Bleach Dispenser

1. Grasp the overflow grate so the word "CAUTION" can be read. Place it in the dispensing compartment as shown in illustration #4.
2. Place the gray siphon cap over the stand pipe in the chlorine bleach dispenser. It should fall into place. (Illustration #5)
3. Grasp the corner lip of the chlorine bleach dispenser. Tilt it slightly to the right and insert it back into the dispenser compartment. (Illustration #6)

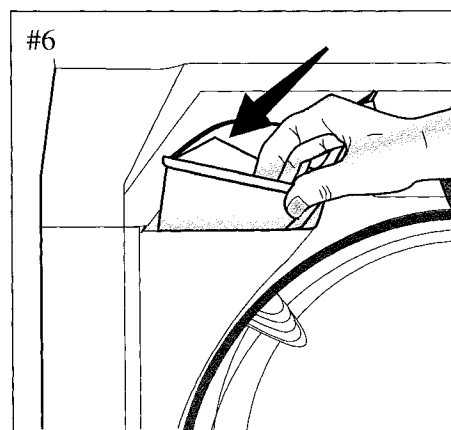
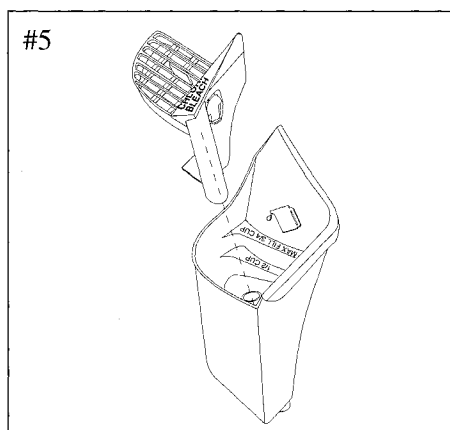
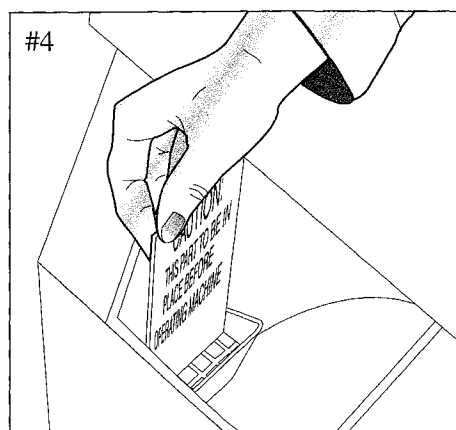
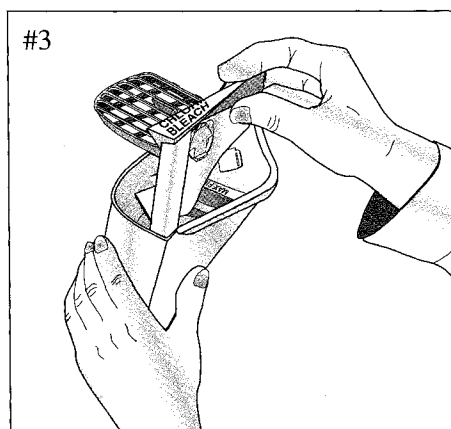
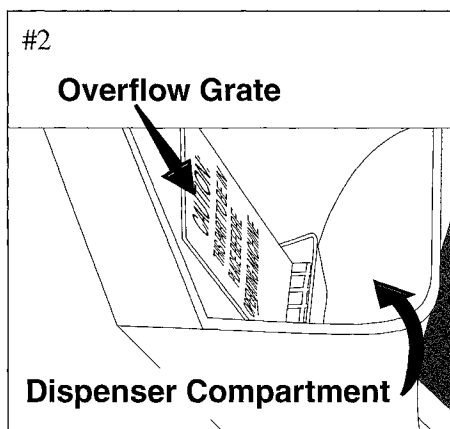
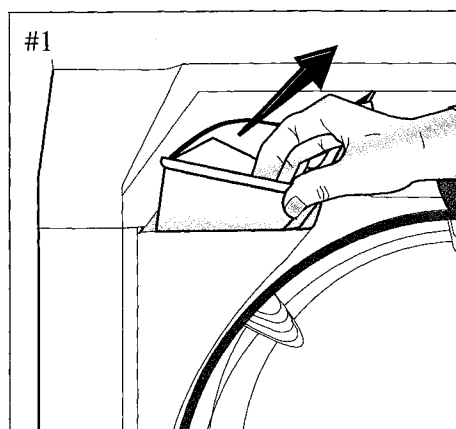

Maytag does not recommend placing the plastic dispenser parts in the dishwasher. If laundry additives were on the parts when washed in the dishwasher, they may cause oversudsing in the dishwasher.

Removing the Fabric Softener Dispenser

1. Grasp the corner lip of the fabric softener dispenser. Lift the dispenser up and tip it to the left to avoid hitting the washer frame. (Illustration #1)
2. Under the fabric softener dispenser in the dispensing compartment is an overflow grate. Grasp the overflow grate by the word "CAUTION" and pull it up and out of the dispensing compartment. (Illustration #2)
3. Take the fabric softener dispenser and the overflow grate to the sink. Be careful, there may be fabric softener left in the dispenser. Lift the light blue siphon cap out of the fabric softener dispenser. (Illustration #3)
4. Run warm water over the dispenser, light blue siphon cap and overflow grate to remove any build-up. A soft cloth may be used for stubborn stains.

Replacing the Fabric Softener Dispenser

1. Grasp the overflow grate so the word "CAUTION" can be read. Place it in the dispensing compartment as shown in illustration #4.
2. Place the light blue siphon cap over the stand pipe in the fabric softener dispenser. It should fall into place. (Illustration #5)
3. Grasp the corner lip of the fabric softener dispenser. Tilt it slightly to the left and insert it back into the dispenser compartment. (Illustration #6)

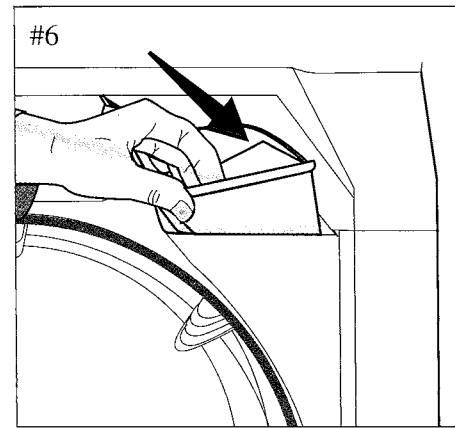
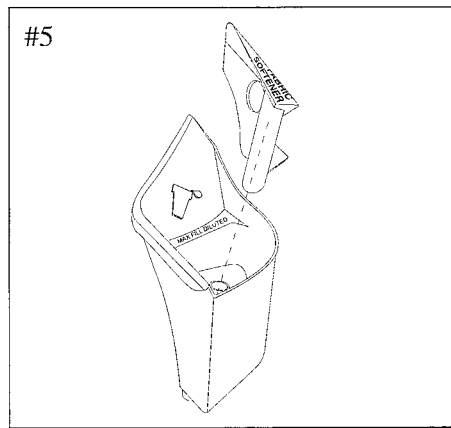
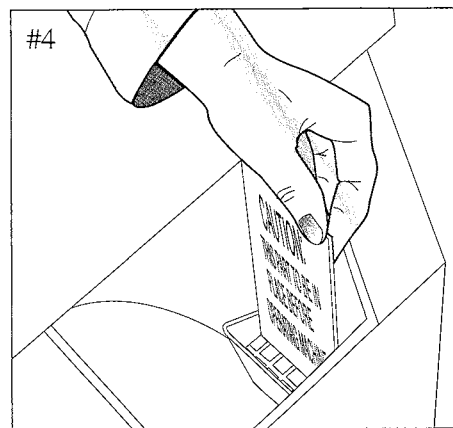
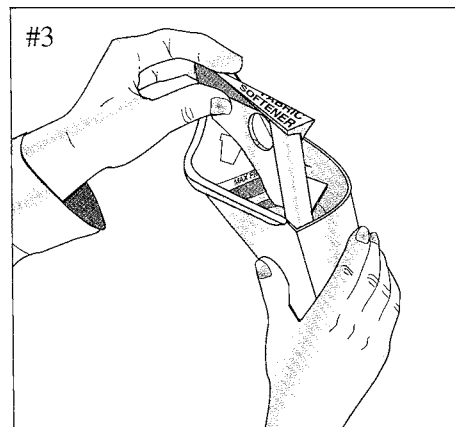
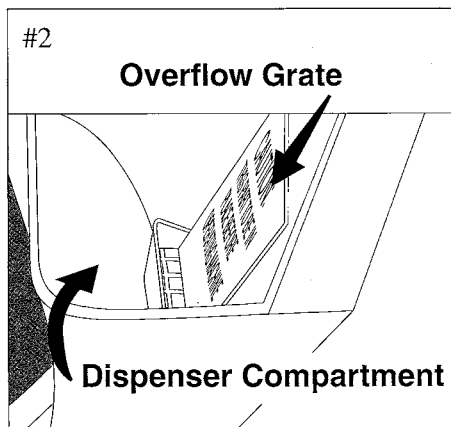
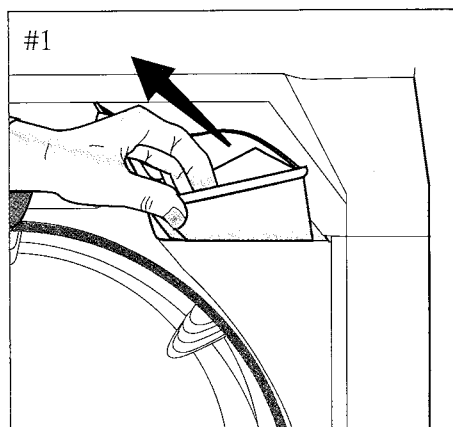

Maytag does not recommend placing the plastic dispenser parts in the dishwasher. If laundry additives were on the parts when washed in the dishwasher, they may cause oversudsing in the dishwasher.

Removing the Chlorine Bleach Grate

The gray siphon cap for chlorine bleach has a grate covering the dispensing compartment. This grate helps prevent items from falling into the bleach dispenser by accident. The grate is detachable for easy clean-up.

When the chlorine bleach compartment is empty, lift the gray siphon cap out of the chlorine bleach compartment. Run water over the entire siphon cap and grate to wash off any excess chlorine bleach. Look at the backside of the siphon cap. Using your thumb, press the bottom

notch up and outward (Illustration #1). The grate should come out of the hole (Illustration #2). Take the pieces to the sink for cleaning.

Replacing the Chlorine Bleach Grate

Place the top two notches in the top of the hole. Using your thumb, press the bottom notch up and outward (Illustration #3). Then replace the siphon tube back into the chlorine bleach dispenser (Illustration #4).

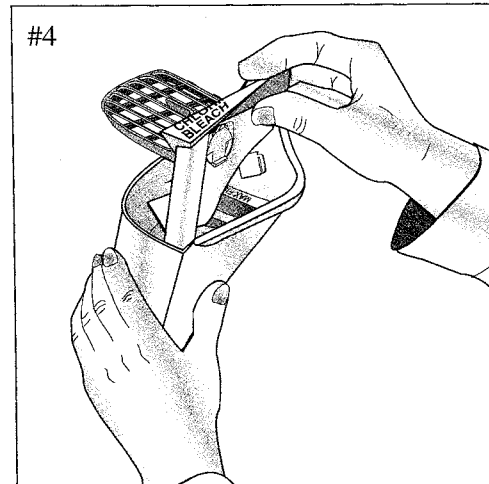
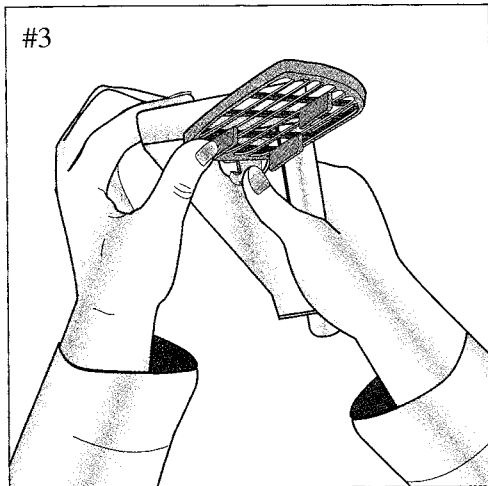
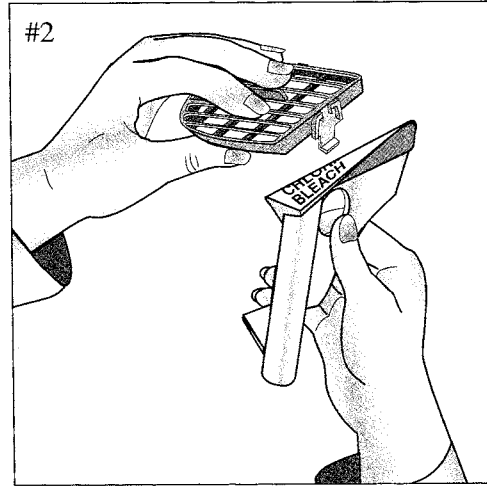
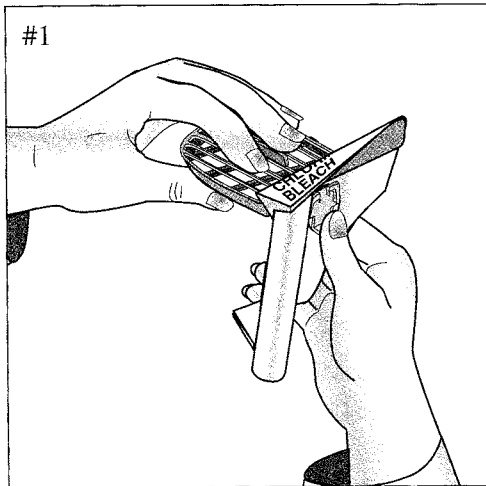

Indicator Lights

- **DOOR LOCKED** – Lights whenever the door of the clothes washer is locked and unable to open. The door can be unlocked by pressing the START/STOP button to stop the clothes washer. It may take approximately 2 minutes for the door to be unlocked.
- **ON** – Indicates when the clothes washer is operating.

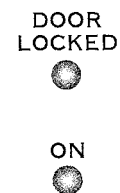



Replacing the Washer Light

Instructions for replacing the bulb:

- 1) Unplug or disconnect the stacked unit from the electrical power supply.
- 2) Open the door and use a Phillips screwdriver to remove the screw attaching the light cover to the door lock assembly.
- 3) Pull down on the light cover.
- 4) Unscrew the light bulb counter clockwise from the socket.
- 5) Replace the bulb with a **120 volt, 10 watt** candelabra base light bulb and rotate clockwise.
- 6) Replace the light cover by inserting the front tabs into the door lock assembly and push the rear of light cover into position.
- 7) Replace the screw into the light cover/door lock assembly.
- 8) Plug in or reconnect stacked unit to the power supply.



Reversing the Clothes Washer Door.....

Clothes washer door swing direction can be changed using the following procedure:

- 1) Swing door fully open and support it while removing four counter sunk hinge screws (which hold hinges to door assembly).
- 2) Set door aside and transfer four color matched door screws to the opposite side of the door assembly.
- 3) Remove one screw holding top hinge to cabinet and one screw holding top hinge cover to cabinet (opposite side).
- 4) Remove hinge and bracket from cabinet by moving them up and down to a position where they are released.
- 5) Install hinge and bracket in swapped locations and drive screws to attach them securely to the cabinet.
- 6) Compare top hinge and top bracket to bottom hinge and bottom bracket for correct assembly position.
- 7) Repeat procedures 4 through 6 for bottom hinge to cabinet and bottom bracket to cabinet.
- 8) Support door in fully open position on hinge side and drive four counter sunk hinge screws to securely attach hinges to door assembly.
- 9) Close door and check to see that clothes washer operates properly.

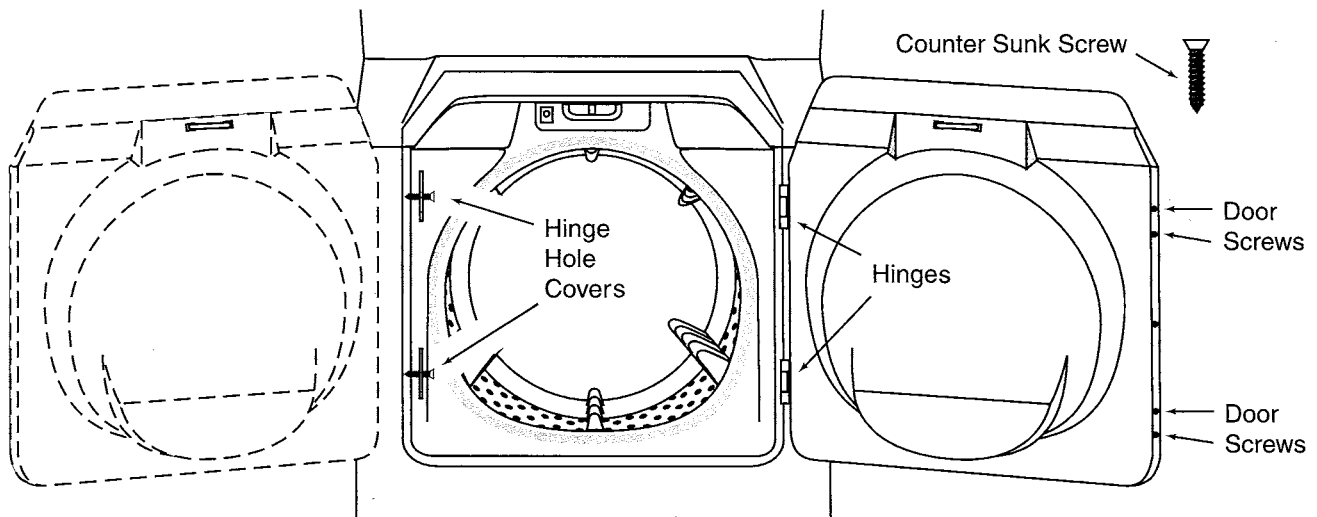

Dryer Controls At A Glance

Step 1 Select Cycle

IntelliDry EASY CARE/PERM PRESS automatically senses the moisture in the load and shuts off when the selected dryness level is reached. This cycle minimizes wrinkles of man-made fabrics such as acrylic, nylon, polyester or blends with an extended cool-down which tumbles the load in unheated air at the end of the cycle. Set the control to the desired dryness level (more dry – less dry). The “▲” is the initial preferred setting for the majority of loads.

Note: The dial can be turned in either direction to select a cycle. Once started, the dial will not advance at a specific rate during the IntelliDry cycles. At first the dial may not advance at all. Toward the end of the cycle (when the load begins to dry) the dial will advance at a more regular rate and much more quickly. This is normal operation.

IntelliDry REGULAR automatically senses the moisture in the load and shuts off when the selected dryness level is reached. This cycle is designed for loads such as towels, underwear, t-shirts, jeans, etc. Set the control to the desired dryness level (more dry – less dry). The “▲” is the initial preferred setting for the majority of loads.

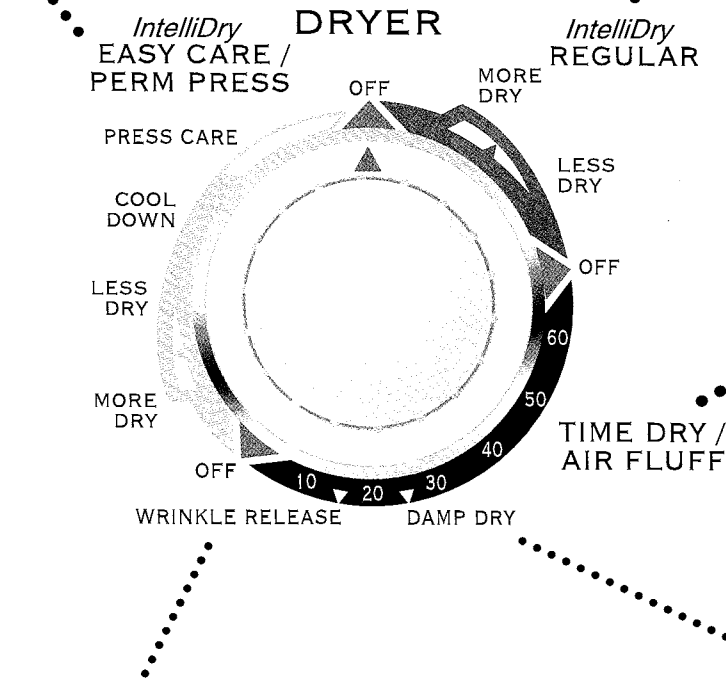

TIME DRY/AIR FLUFF may be selected for any load if the *IntelliDry* sensor system is not desired. Set the control to the desired number of minutes.

WRINKLE RELEASE will release wrinkles from items that are clean and dry but slightly wrinkled, such as from a crowded closet or suitcase or from sitting in the dryer too long after the end of the cycle. It provides 10 minutes of heated tumbling and 5 minutes of cool down tumbling without heat.

DAMP DRY is designed to “partially” dry items. It provides approximately 20 minutes of heated tumbling and 5 minutes of cool down tumbling without heat.

Step 2 Select Temperature

REGULAR – for sturdy cottons or those labeled “Tumble Dry”.

MEDIUM – for permanent press, synthetics, light-weight cottons or items labeled “Tumble Dry Medium”.

DELICATE – for heat sensitive items labeled “Tumble Dry Low” or “Tumble Dry Warm”.

AIR FLUFF – tumbles without heat. Used for sensitive loads or items needing freshening.

TEMPERATURE

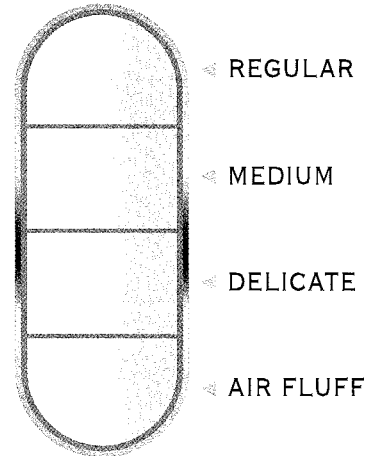

Step 3 Press Start

Push this button to start the dryer. The dryer door must be shut for the dryer to operate. If the door is opened during the cycle, the start button must be pushed again to resume the cycle after the door is closed.

When the cycle is complete, a signal will sound momentarily.

START

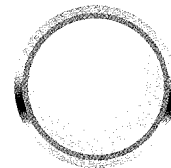

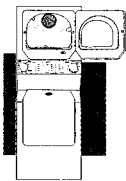

Dryer Operating Tips

Clean the Lint Filter...

- after each load.
- to shorten drying time.
- to operate more efficiently.

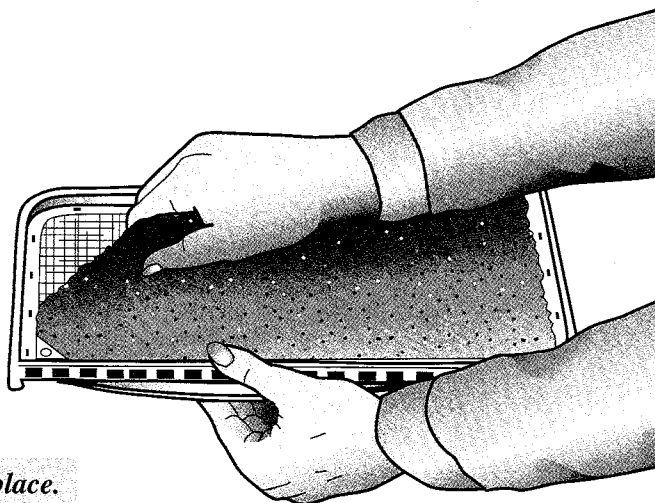

NOTE: Do not operate the dryer without the lint filter in place.

Load the Dryer Properly...

- by placing only one wash load in the dryer at a time.
- by avoiding very small loads or mixed loads.
- by adding one or more similar items to the dryer when only one or two articles need drying. This improves the tumbling action and drying efficiency.

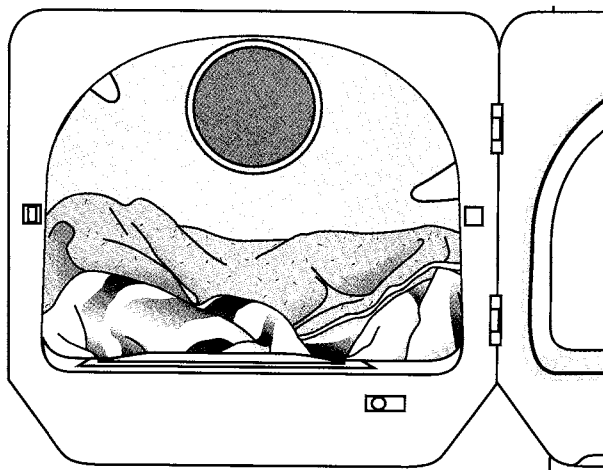

Add A Fabric Softener Sheet...

(If Desired)

- after loading the dryer.
- to control static cling.
- before the load becomes warm. This helps prevent greasy-looking softener stains.
- and remove any used softener sheets from the dryer to prevent greasy-looking softener stains.



Dryer Exhaust Tips.....

⚠ WARNING — Plastic or nonmetal flexible duct presents a potential fire hazard.

Do

Read the installation instructions and the user's guide.

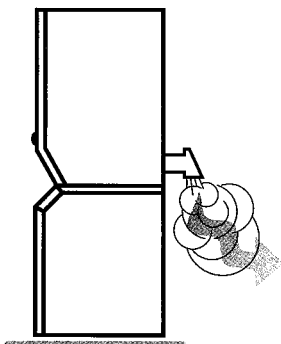

Do

Let your dryer exhaust the air easily.

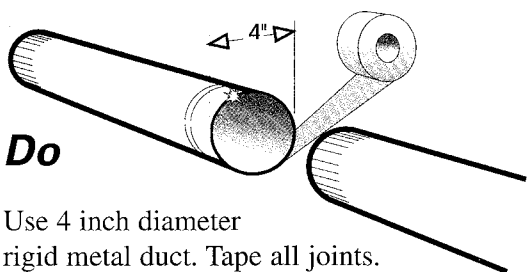

Do

Use 4 inch diameter rigid metal duct. Tape all joints. Never use lint-trapping screws.

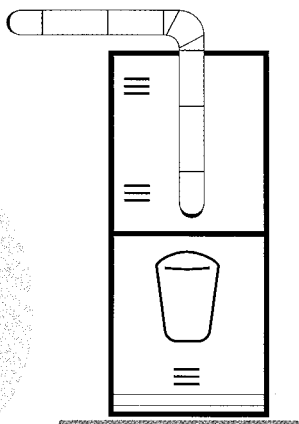

Do

Keep duct runs as straight as possible.

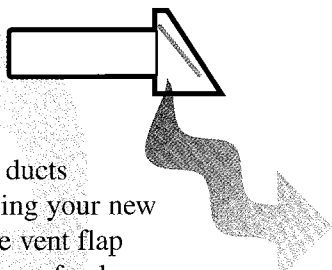

Do

Clean all old ducts before installing your new dryer. Be sure vent flap opens and closes freely.

Don't

Let a poor exhaust system cause slow drying.

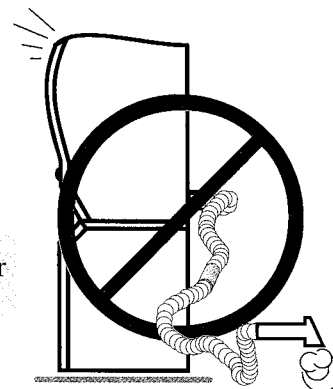

Don't

Restrict your dryer with a poor exhaust system.

Don't

Use plastic, thin foil, or non-metal flexible duct.

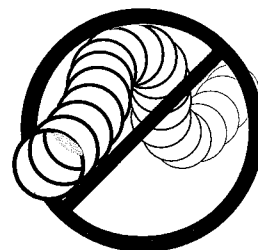

Don't

Use longer than necessary duct runs with many elbows.

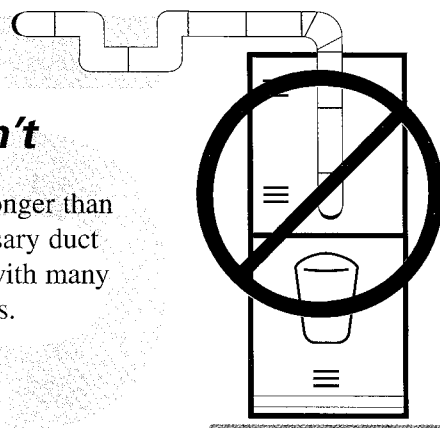

Don't

Allow crushed or clogged ducts and vent.

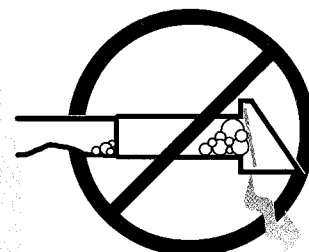



Replacing the Drum Light

Instructions for replacing the bulb:

- 1) Unplug or disconnect the stacked unit from the electrical power supply.
- 2) Open the door and use a Phillips screwdriver to remove the screw attaching the lens to the tumbler front.
- 3) Remove lens cover by pulling cover toward center of tumbler.
- 4) Rotate bulb counter-clockwise to remove from socket.
- 5) Replace the bulb with a **120 volt, 10 watt maximum** candelabra base light bulb.
- 6) Turn the light bulb clockwise into socket.
- 7) Replace lens cover by hooking plastic tabs into tumbler front below the light housing.
- 8) Reinstall the screw into the lens cover screw hole.
- 9) Reconnect stacked unit to power supply.



Reversing the Dryer Door.....

Directions for reversing the dryer door.

- 1) Carefully remove the hinge hole covers with a flathead screwdriver. Move the door catch cover to the opposite side.
- 2) While supporting the door, remove the 4 counter sunk hinge screws which secure the hinges to the cabinet. When removing the 4 counter sunk hinge screws, alternate between the top and bottom hinge to prevent bending the hinge.
- 3) Move the following parts to the opposite side of the door: 2 hinges, 4 counter sunk hinge screws and 4 door screws; door strike and screw; inner door cover plate and screw.
- 4) Attach the door to the opposite side of the cabinet using the 4 counter sunk hinge screws. (See below). Screw the lower counter sunk hinge screw in first. This will help to align the door and hinges.
- 5) Replace the hinge hole covers to the opposite side.

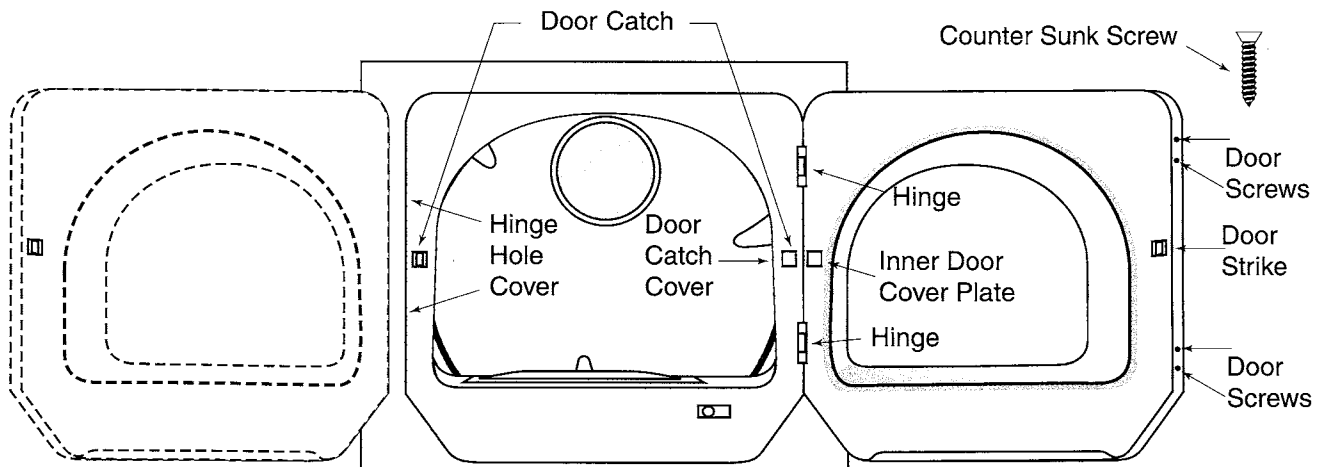



Water Use.....

The amount of water used to wash loads of laundry will vary with each load. The Maytag Neptune™ stacked washer uses an IntelliFill device to provide the appropriate amount of water for efficient cleaning performance and conservation of water and energy.

ate amount of water for efficient cleaning performance and conservation of water and energy.



Care and Cleaning.....

Washer

Turn off the water faucets after finishing the day's washing. This will shut off the water supply to the clothes washer and prevent the unlikely possibility of damage from escaping water.

Use a soft cloth to wipe up all detergent, bleach or other spills as they occur.

Clean the following as recommended:

Control Panel – clean with a soft, damp cloth or glass cleaner. Do not use abrasive powders or cleaning pads.

Cabinet – clean with soap and water followed with an appliance wax, if desired.

Interior – hard water deposits may be removed, if needed, using a recommended cleaner labeled clothes washer safe.

Dryer

Tumbler – If the tumbler becomes stained by a crayon, ink pen or other item inadvertently left in a garment, clean the tumbler with an all purpose cleaner such as: Fantastik, Soft Scrub or Formula 409®.* Then tumble old towels or rags to remove any excess stain or cleaning substance.

Exhaust System Cleaning – While the lint filter will catch most of the lint from the load, some will get through and may buildup in the ductwork. It is important to completely inspect and clean all lint accumulation from the interior of the ductwork once a year to maintain drying performance. The exhaust hood at the outside of the home should be cleaned more frequently to ensure the damper opens and closes freely.

Refer to the Installation Instructions for more details on proper exhausting.

**Brand names are trademarks of the respective manufacturers.*



Storing the Neptune™ Super Stack.....

Washers can be damaged if water is not removed from hoses and internal components before storage. Prepare the washer for storage as follows:

- Select the ▲ setting on the REGULAR cycle of the clothes washer and press the START/STOP button. After one minute of filling, stop the washer and open the door. Mix one cup of bleach or vinegar with four cups of water and pour the solution into the tub. Close the door, press the START/STOP button and allow the washer to complete a cycle.
- Turn the water faucets off and disconnect the inlet hoses.
- Advance the cycle control knob to Spin and lower the drain hose to eliminate any water that may be in the drain hose.

- Disconnect the clothes washer from the electrical supply and leave the washer door open to let air circulate inside the tumbler.
- Clean the dryer tumbler with an all purpose cleaner such as Fantastik or Formula 409* and disconnect from power supply.

For extended periods of storage or storage during extreme cold temperatures, call Maytag Customer Assistance toll-free at 1-888-462-9824.

U.S. customers using TTY for deaf, hearing impaired or speech impaired, call 1-800-688-2080.



Washer Operating Sounds

Normal operating sounds of your Maytag Neptune™ clothes washer

High pitched sound during a spin cycle.	This occurs as the motor increases speed to spin the tub to remove moisture from the load.
Flushing water sound coming from the dispenser area.	Water enters the dispensers to flush chlorine bleach and/or fabric softener into the tumbler during the appropriate time of the cycle.
Sloshing or gurgling water sound from inside the washer when the tub is rotated.	This sound comes from the sealed counter balance ring. It is used to make the washer run more smoothly and efficiently.
“Whirring” sound followed by a pause, repeated throughout the wash cycle.	The tub rotates one direction followed by a pause. The tub reverses direction and pauses.
Clothes washer maintains a slightly reduced spin speed after achieving a higher spin speed.	After reaching the maximum spin speed, the machine may reduce spin speed slightly to create less noise and vibration.
The spin speed slows down dramatically when it sounds like an out-of-balance load.	The tumbler will begin to accelerate up to speed, then slows back down to redistribute the load more evenly.
Clothes washer adds water after it has been tumbling for a while.	<p>The Maytag Neptune™ clothes washer uses a true adaptive fill. This will add more water during the wash cycle as it is needed.</p> <p style="text-align: center;">OR</p> <p>Water is being added to the dispensers to dilute and rinse chlorine bleach or fabric softener into the tumbler at the appropriate time. This will occur even if chlorine bleach and fabric softener are not used.</p>

If you are unsure about an operating sound, the Video User's Guide may provide further assistance. The normal operating sounds listed on this page can be heard on the video.



Before You Call.....

For problem laundry solutions (i.e. fabric damage, residue, tangling) and special laundry care procedures, see the enclosed Laundering Tips pamphlet.

Check these points if your clothes washer...

Won't Fill

- Be sure the door is tightly closed.
- ON light should be lit
- Plug cord into a live electrical outlet.
- Check fuse or reset circuit breaker.
- Turn the control dial to the proper cycle and push the START/STOP button. Be sure the buttons are fully depressed.
- Turn both faucets on fully.
- Straighten inlet hoses.
- Disconnect hoses and clean screens. Hose filter screens may be plugged.
- Open and close the door, then push the START/STOP button.
- Low water pressure.

Won't Tumble

- Check fuse or reset circuit breaker.
- Turn the control dial to proper cycle and push the START/STOP button. Be sure the buttons are fully depressed.
- Close the door and push the START/STOP button. For your safety, the clothes washer will not tumble or spin unless the door is closed.
- ON light should be lit

Won't Spin or Drain

- Check fuse or reset circuit breaker.
- Straighten drain hoses. Eliminate kinked hoses. If there is a drain restriction, call for service.
- Close the door and push the START/STOP button. For your safety, washer will not tumble or spin unless the door is closed.
- After pressing the START/STOP button, it may take a few moments before the clothes washer begins to spin. The door must lock before spin can be achieved.

Door Locked Shut; Will Not Open

- Press the START/STOP button to stop the washer.
- It may take 1 1/2 to 2 minutes for the door lock mechanism to disengage.
- Pull on the door indentation opposite the hinges.

(Continued on next page.)



Before You Call (continued).....

Check these points if your clothes washer...

Stops	<ul style="list-style-type: none"> • Plug cord into live electrical outlet. • Check fuse or reset circuit breaker. • Turn the control dial to proper cycle and push the START/STOP button to start the clothes washer. Be sure the buttons are fully depressed. • Close door and push the START/STOP button to start the clothes washer. For your safety, washer will not tumble or spin unless door is closed. • This may be a pause or soak period in the cycle. Wait briefly and it may start. • Low water pressure. Try not to run a shower and/or dishwasher at the same time.
Leaks Water	<ul style="list-style-type: none"> • Make sure hose connections are tight. • Make sure end of drain hose is correctly inserted and secured to drain facility. • Avoid overloading.
Is Noisy	<ul style="list-style-type: none"> • Clothes washer should be leveled properly as outlined in installation instructions. • Weak floors can cause vibration and walking. • Be sure rubber feet are installed on leveling legs. • Check that the leveling leg lock nuts are tightened.
Fills with the Wrong Temperature Water	<ul style="list-style-type: none"> • Turn both faucets on fully. • Check that the temperature selector button is fully depressed. • Make sure temperature selection is correct. • Make sure hoses are connected to correct faucets and inlet connections. Flush water line before filling washer. • Check the water heater. It should be set to deliver a minimum 120°F (49°C) hot water at the tap. Also check water heater capacity and recovery rate. • Disconnect hoses and clean screens. Hose filter screens may be plugged.
Cycle Selector Knob Advances Through “off”	<ul style="list-style-type: none"> • Extra rinse option is selected.
Tub is Completely Full of Suds	<ul style="list-style-type: none"> • Run the clothes washer through another complete cycle using cold water. • Reduce detergent amount for that specific load size and soil level. • Use high efficiency or low sudsing detergent specially formulated for front load washers. • See “Won’t Spin or Drain” section on page 19.

Check these points if your clothes dryer...

Doesn't Run

- Plug cord into live electrical outlet.
- Check fuse or reset circuit breaker.
- Check the home's circuit breaker and fuses.
- Press the START button again if the door is opened during the cycle.

Doesn't Heat

- Check fuse or reset circuit breaker.
- Select a heat setting, not air-fluff.
- On a gas dryer, check that the gas supply is on.
- Clean the lint filter and exhaust duct.

Doesn't Dry

- Check all of the above, plus...
- Be sure the exhaust hood at the outside of the home can open and close freely.
- Use 4" rigid metal exhaust duct.
- Do not overload. 1 Wash load = 1 Dryer load.
- Sort heavy items from lightweight items.
- Check that the washer is draining properly to extract adequate water from the load.

Is Noisy

- Check the load for objects such as coins, loose buttons, nails, etc. Remove promptly.
- Be sure the Super Stack is leveled properly as outlined in the installation instructions.
- Be sure the rubber feet are installed on the leveling legs.
- Check that the leveling leg lock nuts are tightened.

Control Knob Advances Slowly

- This is normal operation for an *IntelliDry* cycle, especially at the beginning of the cycle. Once the load begins to dry, the control knob will start to advance. The rate of advancement will be slow at the beginning of the cycle because there is more moisture in the load. As the load becomes more dry, the control knob will advance more quickly.

What is not covered by the warranties on the next page:

- Conditions and damages resulting from any of the following:
 - Improper installation, delivery, or maintenance.
 - Any repair, modification, alteration or adjustment not authorized by the manufacturer or an authorized servicer.
 - Misuse, abuse, accidents, or unreasonable use.
 - Incorrect electric current, voltage or supply.
 - Improper setting of any control.
 - Warranties are void if the original serial numbers have been removed, altered, or cannot be readily determined.
 - Light bulbs.
 - Products purchased for commercial or industrial use.
 - The cost of service or service call to:
 - Correct installation errors.
 - Instruct the user on proper use of the product.
 - Transport the appliance to the servicer.
 - Consequential or incidental damages sustained by any person as a result of any breach of these warranties.
- Some states do not allow the exclusion or limitation of consequential or incidental damages, so the above exclusion may not apply.



Maytag® Neptune™ Super Stack Warranty

Full One Year Warranty

For **one (1) year** from the date of original retail purchase, any part which fails in normal home use will be repaired or replaced free of charge.

Limited Parts Warranty

After the first year from the date of original retail purchase through the time periods listed below, the parts designated below which fail in normal home use will be repaired or replaced free of charge for the part itself, with the owner paying all other costs, including labor, mileage and transportation.

Second Year – All parts.

Third through Fifth Year – Dryer tumbler.

Third through Tenth Year – The washer drive motor.

Third through Lifetime – Stainless steel inner wash basket.

Additional Limited Warranty Against Rust-Through

Should any of the parts listed below rust-through during the one year period starting from the date of retail purchase, repair or replacement will be made free of charge. After the first and through the tenth year, repair or replacement will be made free of charge for the part itself, with the owner paying all other costs, including labor, mileage and transportation.

Automatic Washer: Exterior cabinet, door and baseframe.

Dryer: Exterior cabinet, top and door.

Please Note: This full warranty and the limited warranties apply when the appliance is located in the United States or Canada. Appliances located elsewhere are covered by the limited warranties only, including parts which fail during the first year.

Canadian Residents

This warranty covers only those appliances installed in Canada that have been listed with Canadian Standards Association unless the appliances are brought into Canada due to transfer of residence from the United States to Canada.

The specific warranties expressed above are the **ONLY** warranties provided by the manufacturer. This warranty gives you specific legal rights, and you may also have other rights that vary from state to state.

To Receive Warranty Service

To locate an authorized service company in your area, call Maytag Customer Assistance toll-free at 1-888-462-9824. Should you not receive satisfactory warranty service, please call or write:

Maytag Appliances Sales Company

Attn: CAIRSM Center

P.O. Box 2370

Cleveland, TN 37320-2370

U.S. or CANADA (toll-free) 1-888-462-9824

U.S. customers using TTY for deaf, hearing impaired or speech impaired, call 1-800-688-2080.

When contacting Maytag Appliances Sales Company, Maytag Customer Assistance about a service problem, please include the following:

- (a) Your name, address and telephone number;
- (b) Model and serial number of dryer (found on the lower center of the dryer door opening) and model and serial number of the washer (found beneath the chlorine bleach dispenser);
- (c) Name and address of your dealer and the date the appliance was purchased;
- (d) A clear description of the problem you are having;
- (e) Proof of purchase.

MAYTAG • One Dependability Square • Newton, Iowa 50208