

use & care guide

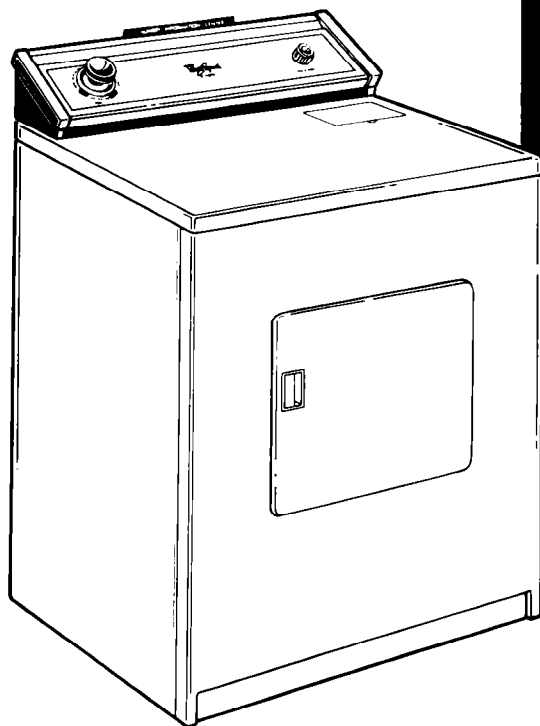



Whirlpool

AUTOMATIC DRYERS

**Electric Model
LE3000XP
and
Gas Model
LG3001XP**

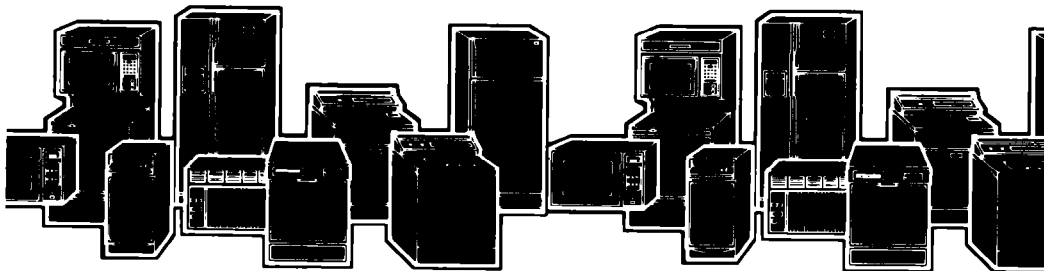
Range Ovens, Trash Compactors, Room Air Conditioners, Dehumidifiers, Automatic Washers, Clothes Dryers, Freezers, Refrigerator-Freezers



Parts and features

CYCLE CONTROL KNOB

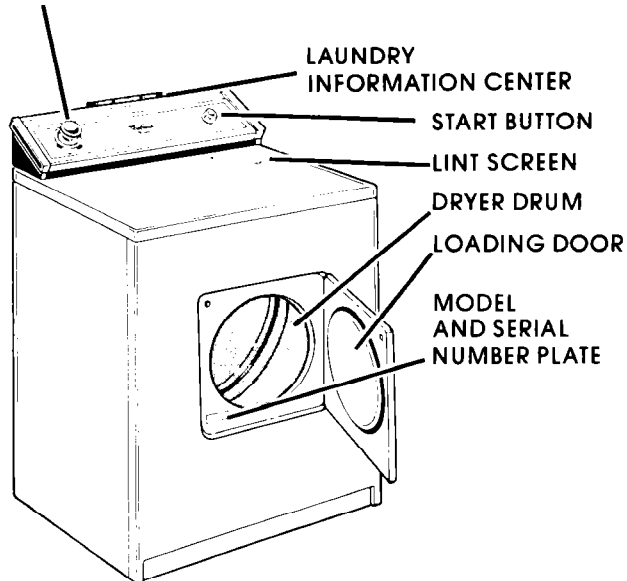

Remove the Consumer Buy Guide label before using your dryer. It will be easier to remove.

Wipe out the dryer drum with a damp cloth to remove dust from storing or shipping.

Copy your Model and Serial Numbers here

When you need service or call with a question, have this information ready:

1. **Complete** Model and Serial Numbers (from the plate located as shown).
2. Purchase date from sales slip.

Copy this information in these spaces. Keep this book, your warranty, sales slip and "Dryer Guide" in the Laundry Information Center on the back of the dryer console.

There is no warranty registration to return. Proof-of-purchase is all that is required for in-warranty service.

Complete Model Number

Complete Serial Number

Purchase Date

Service Company and Telephone Number

Contents

	Page		Page
PARTS AND FEATURES	2	IF YOU NEED SERVICE OR ASSISTANCE	8
YOUR RESPONSIBILITIES	3	1. Before Calling for Assistance	8
SAFETY FIRST	3	2. If You Need Assistance ..	9
STARTING YOUR DRYER	4	3. If You Need Service	9
SELECTING A CYCLE	5	4. If You Have a Problem ...	9
LINT SCREEN	6		
LINT REMOVAL	6		
CARING FOR YOUR DRYER ...	7		

©1984 Whirlpool Corporation

Your Responsibilities

Read this "Use and Care Guide" and your "Dryer Guide" carefully for important use and safety information.

You are personally responsible for making sure that your dryer...

- is installed by a qualified installer.
- is properly maintained.
- is installed in an area protected from the weather.
- is properly installed and leveled in a well ventilated room* on a floor that can support the weight.

- is located in an area where the temperature is above 45°F (7.2°C).
 - is connected to the right kind of outlet, electric supply and grounding.*
 - is properly connected to fuel and exhaust systems.*
 - is used only for jobs normally expected of home clothes dryers.
 - is not run where there may be explosive fumes.
 - is not used by children or anyone unable to operate it properly.
- *See the "Installation Instructions" for complete information.

Safety first

ALWAYS unplug the power supply cord or turn off electrical power before attempting to service the dryer. **Shut off the GAS VALVE** if yours is a gas dryer.

ALWAYS shut off the gas valve before leaving on vacation.

NEVER use flammable fluids (dry-cleaning solvents, gasoline, kerosene) in or near your dryer.

ALWAYS hand launder or air dry fabrics treated with flammable fluids before putting them into your dryer.

NEVER dry items containing wax or paint in the dryer. The fumes can create a **FIRE HAZARD**.

FIRE HAZARD and **DAMAGE** to some materials can result from:

- drying heat-sensitive materials with heat (see page 5).
- operating the dryer with the lint screen loose, damaged or missing.
- allowing lint to build up inside the dryer (see page 6).

NEVER allow children to operate, play with, or crawl inside the dryer.

NEVER operate the dryer if...

- it is not working right.
- it is damaged.
- parts are missing.
- all panels are not in place.

DO NOT let dust, lint, paper, rags, chemicals, etc., pile up around or under the dryer. **DO NOT** install against drapes or curtains.

• FOR YOUR SAFETY •

IF YOU SMELL GAS:

1. OPEN WINDOWS.
2. DON'T TOUCH ELECTRICAL SWITCHES.
3. EXTINGUISH ANY OPEN FLAME.
4. IMMEDIATELY CALL YOUR GAS SUPPLIER.

• FOR YOUR SAFETY •

DO NOT STORE OR USE GASOLINE OR OTHER FLAMMABLE VAPORS AND LIQUIDS IN THE VICINITY OF THIS OR ANY OTHER APPLIANCE.

• SAVE THESE INSTRUCTIONS •

Starting your dryer

Before starting your dryer, be sure laundry is sorted and loaded properly (see your "Dryer Guide"). **Be sure the door is tightly closed.**

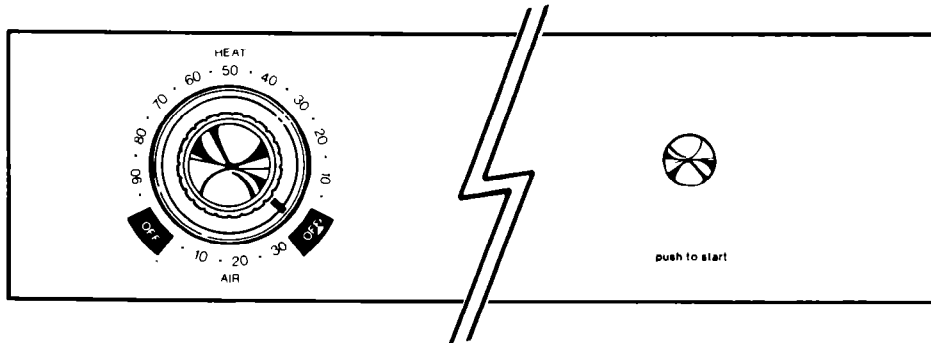

1. Select CYCLE and TIME

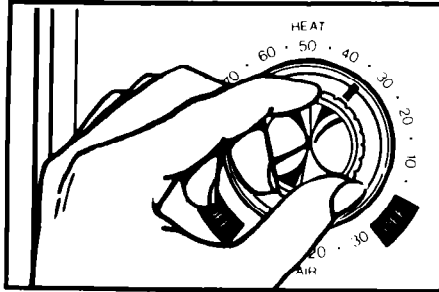

Turn the Control Knob either way to point to the time setting you want in the cycle you want.

2. Push the START Button

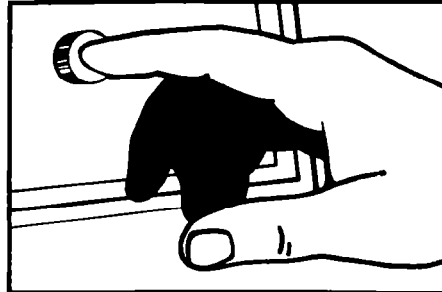

The dryer will start tumbling when you push the START Button.

3. To stop and restart the dryer

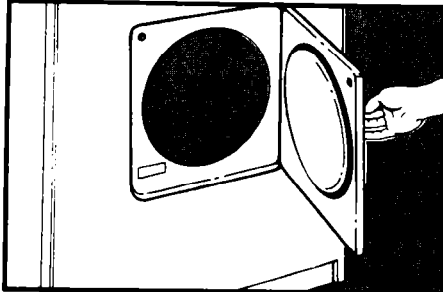

To stop, open the door (or turn the Control Knob to OFF).

To restart, close the door and push START.

4. To change the setting

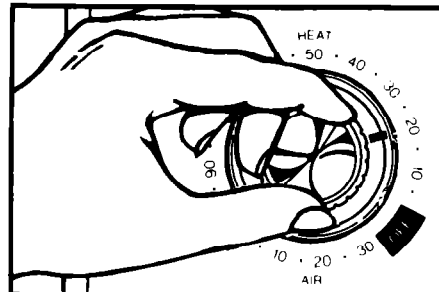

The setting can be changed at any time by turning the Control Knob to a new setting.

The Cycle Control Knob should point to OFF when the dryer is not in use.

Selecting a cycle

Each dryer cycle is designed to dry certain kinds of fabrics. Use the chart below to help you decide which cycle to use.

TYPE OF LOAD	SUGGESTED CYCLE
COTTONS	
HEAVY – Bedspreads, mattress pads, quilts	HEAT
MEDIUM AND LIGHTWEIGHT – Shirts, dresses, sheets, diapers, towels, work clothes	HEAT
PERMANENT PRESS	
HEAVY – Work clothes, jackets, raincoats, etc.	HEAT
MEDIUMWEIGHT – Shirts, uniforms, dresses, slacks, etc.	HEAT
KNITS	
HEAVYWEIGHT – COTTONS, RAYONS, BLENDS –	
T-Shirts, slacks, polo shirts, etc.	HEAT
LIGHTWEIGHT – SYNTHETIC FIBERS (polyester, acrylic, etc.) AND BLENDS –	
Lingerie, blouses, dresses, etc.	HEAT
DELICATELY CONSTRUCTED FABRICS –	
Sheer Curtains (2 or 3 panels)	HEAT
RUBBER, PLASTIC, HEAT SENSITIVE MATERIALS	
Foam pillows, bras, etc.	AIR
Plastic shower curtains, tablecloths	AIR
Rubber backed rugs	AIR
Olefin, polypropylene, sheer nylon	AIR

WARNING: Drying these and other heat-sensitive materials with heat can damage them or be a FIRE HAZARD.

The last 5 minutes of the HEAT Cycle are without heat. This helps cool down the load for easier handling and to reduce wrinkling.

Drying times

Drying times will vary depending on:

- amount of moisture in the clothes.
- type and weight of the fabric.
- size of the load.
- room temperature around the dryer.

See page 6 in your "Dryer Guide" for more information.

To help reduce wrinkling, take the load from the dryer as soon as tumbling stops. This is very important for permanent press, knits and other synthetic fabrics.

Mixed loads

When drying a load with different kinds and weights of fabrics, use the cycle suggested for the lightest fabrics. When the dryer stops, remove dry items and reset the control.

DO NOT OVERDRY. Overdrying can cause shrinkage, static cling, and can damage some fabrics.

Lint screen

Clean the lint screen before each load. A screen blocked by lint can increase drying time and may be a FIRE HAZARD.

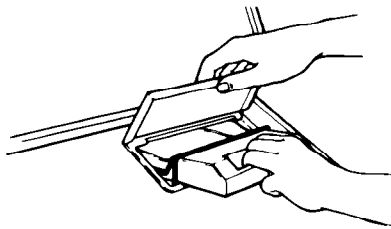

Open the lid and pull the lint screen straight out.

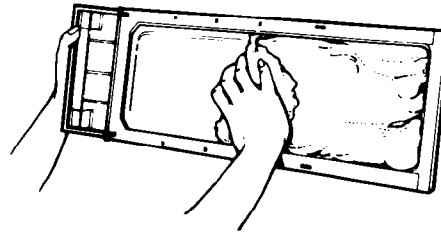

ROLL the lint off the screen with your fingers.
DO NOT rinse or wash the screen.
Push the screen firmly back into place.



WARNING: DO NOT run the dryer with the lint screen loose, damaged or missing. Doing so can cause overheating, can damage fabrics and can be a **FIRE HAZARD**.

Lint removal

Lint can gather inside the dryer and create a fire hazard. **This lint should be removed every 2 to 3 years, or more often, depending on dryer usage.**

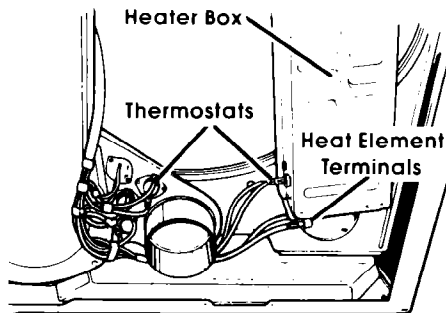

ELECTRIC DRYERS

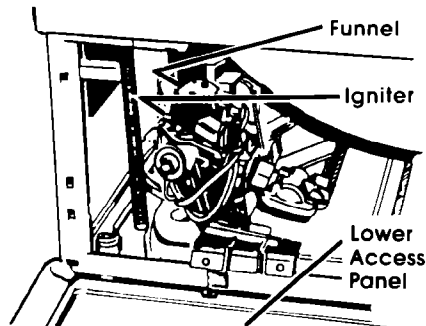

GAS DRYERS

Cleaning should be done only by a qualified person.



- Avoid electrical shock hazard – unplug power supply cord or turn off electrical power.
- Avoid injury or damage – do not put hands inside cabinet.
- Make sure dryer is cool.

1. Remove back panel (electric) or lower access panel (gas).
2. Avoid damaging wires, thermostats, funnel or igniter.
3. Remove lint from shaded area – see art – with a soft brush or vacuum cleaner.
4. Replace panel; reconnect and re-level dryer.

Caring for your dryer

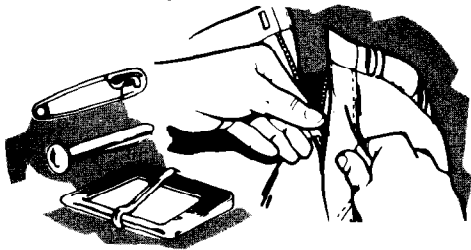

Remove sharp objects from clothing before drying – pins, buckles, etc. **Close metal zippers.**

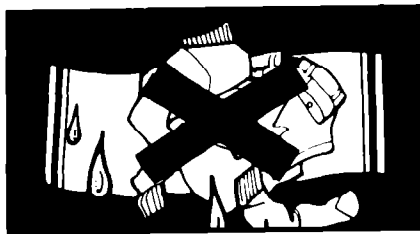

Never leave wet or damp laundry in your dryer.

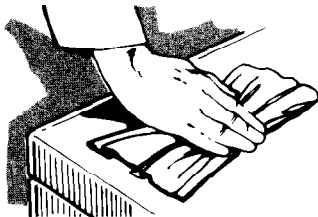

Wipe off all spills with a damp, soft cloth. Spills allowed to remain may dull or damage the finish.

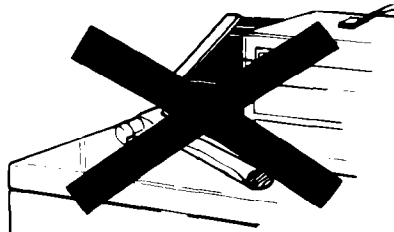

Sharp or heavy objects should never be put on or in the dryer. Check pockets for bolts, nuts, etc.

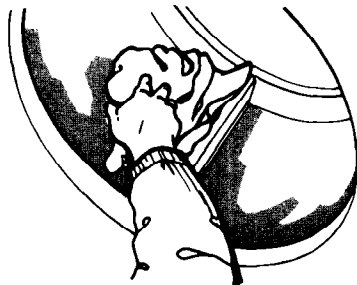

Non-colorfast items can stain the drum. **Wipe carefully** after drying to make sure there is no dye to be transferred to items in the next load.

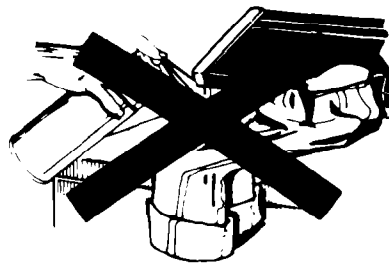

Some pretreatment products can damage dials, console and finish. Do not use these products on or near your dryer.

Vacation care

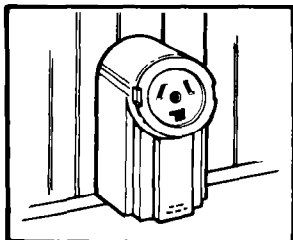

Unplug power cord or turn off electrical power.

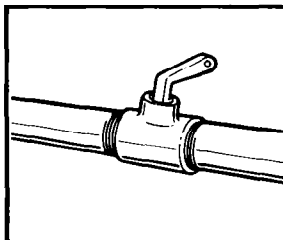

For gas dryers, close gas valve.

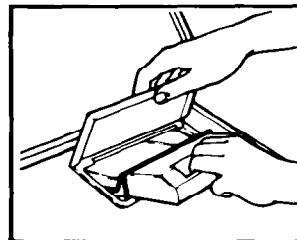

Clean lint screen.

If you need service or assistance, we suggest you follow these four steps:

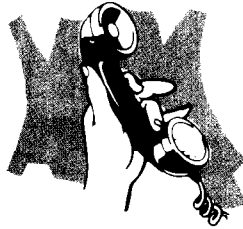

1. Before calling for assistance...

Performance problems often result from little things you can find and fix yourself without tools of any kind.

DRYER DOES NOT RUN:

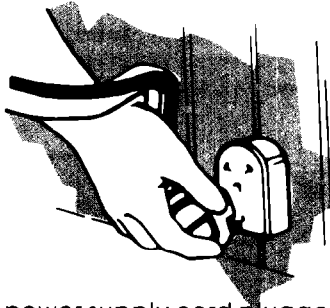

- Is power supply cord plugged in?
- Is door closed tightly?
- Did you push START Button?

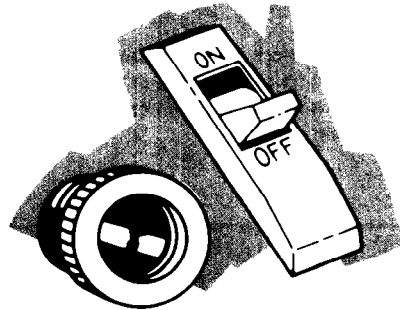

- Are fuses blown or a circuit-breaker tripped?

DRYER DOES NOT HEAT:

- The AIR setting is without heat.
- The last minutes of heat settings are without heat.

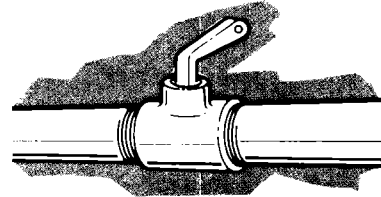

- Is gas turned on? If not, turn Control Knob to OFF. Turn on gas. Wait 5 minutes. Reset controls and start.
- An electric dryer uses a circuit breaker or 2 fuses. If one fuse is blown, the dryer may run, but not heat.

DRYING TIME SEEMS LONG:

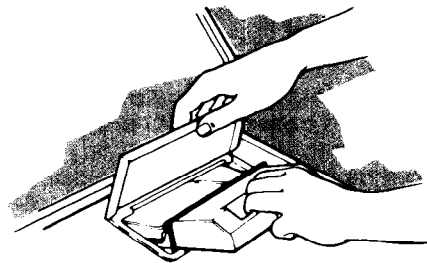

- Is the lint screen clean?
- See page 6 in your "Dryer Guide."

2. If you need assistance*...

Call Whirlpool COOL-LINE® service assistance telephone number.

Dial free from:

Continental U.S. . . (800) 253-1301
 Michigan (800) 632-2243
 Alaska & Hawaii (800) 253-1121

and talk with one of our trained Consultants. The Consultant can instruct you in how to obtain satisfactory operation from your appliance or, if service is necessary, recommend a qualified service company in your area.

3. If you need service*...



Whirlpool has a nationwide network of franchised TECH-CARE® Service Companies.

TECH-CARE service technicians are trained to fulfill the product warranty and provide after-warranty service, anywhere in the United States. To locate TECH-CARE service in your area, call our COOL-LINE service assistance telephone number (see Step 2) or look in your telephone directory Yellow Pages under:

APPLIANCES - HOUSEHOLD MAJOR - SERVICE & REPAIR	OR	ELECTRICAL APPLIANCES - MAJOR - REPAIRING & PARTS
WHIRLPOOL APPLIANCES FRANCHISED TECH-CARE SERVICE		WHIRLPOOL APPLIANCES FRANCHISED TECH-CARE SERVICE
SERVICE COMPANIES		SERVICE COMPANIES
XYZ SERVICE CO 123 Maple 999-9999		XYZ SERVICE CO 123 Maple 999-9999
OR		
WASHING MACHINES, DRYERS & IRONERS - SERVICING		
WHIRLPOOL APPLIANCES FRANCHISED TECH-CARE SERVICE		
SERVICE COMPANIES		
XYZ SERVICE CO 123 Maple 999-9999		

4. If you have a problem*...

Call our COOL-LINE service assistance telephone number (see Step 2) and talk with one of our Consultants, or if you prefer, write to:

Mr. Robert F. Gunts, Vice President
 Whirlpool Corporation
 Administrative Center
 2000 US-33 North
 Benton Harbor, MI 49022

*If you must call or write, please provide: model number, serial number, date of purchase, and a complete description of the problem. This information is needed in order to better respond to your request for assistance.



FSP is a registered trademark of Whirlpool Corporation for quality parts. Look for this symbol of quality whenever you need a replacement part for your Whirlpool appliance. FSP replacement parts

will fit right and work right, because they are made to the same exacting specifications used to build every new Whirlpool appliance



Making your world a little easier.

Part No. 693685
©1984 Whirlpool Corporation

Printed in U.S.A.

matic Washers, Clothes Dryers, Freezers, Refrigerator-Freezers, Ice Makers, Dishwashers, Built-In Ovens and Surface Units, Ranges, Mic

