

Owner's Guide

Gas Range with Self-Cleaning Oven

1st PROOF
12-02-97
OK TO PRINT
msterch
12-3-97
SUGS 32/257
14

TABLE OF CONTENTS

IMPORTANT SAFETY INSTRUCTIONS	1-4	Automatic oven cooking	16
CLOCK, TIMER, OVEN CONTROL	5-6	Broiling and chart	17-18
SURFACE COOKING	7-10	SELF-CLEAN OVEN	19-20
Pilotless ignition system	7	CARE AND CLEANING CHART	21-23
Lighting surface burners	7	MAINTENANCE	24-27
Selecting flame size	8	Cooktop	24
About the surface flame	8	Burner grates	24
Adjusting the flame	8	Oven light	24
Conventional surface burners, select models	9	Oven door	25
Sealed surface burners, select models	9	Door lock lever	25
Cookware	10	Oven bottom	25
Canning	10	Oven racks	26
OVEN USE	11-18	Storage drawer	27
Pilotless ignition system	11	Leveling legs	27
Oven burner	11	How to remove range for cleaning and servicing	27
Oven vent	11	SERVICE	28-31
General information	11	Electrical connection	28
Oven Control lock-out feature	11	Proportional valve adjustment	28
How to set oven to bake or roast	12	Adjusting oven temperature	28
General baking tips	13	Explanation of fault codes	28
Preheating	13	Troubleshooting chart	29-30
Use of aluminum foil	13	How to obtain service	31
Common baking problems	14	WARRANTY	31
Roasting and chart	15		

INSTALLER Please leave this manual with this appliance.

CONSUMER To save you time, energy and money, read and keep this manual for future reference.

The model and serial numbers are found on the rating plate located on the sides of the lower range front frame.

Model Number: _____

Serial Number: _____

Date of Purchase: _____

Please keep your sales receipt and/or your cancelled check as proof of purchase should warranty service be needed. Store these documents with this booklet.

FOR CUSTOMER ASSISTANCE CALL 1-800-688-1120

8113P173-60
(12-97-00)

IMPORTANT SAFETY INSTRUCTIONS

Read all instructions before using this appliance.

Thank You . . . for purchasing our cooking appliance. To help you obtain the maximum in cooking satisfaction, we offer these suggestions:

- ☞ Read this manual before using the appliance.
- ☞ Review all safety and caution instructions.
- ☞ Review the Troubleshooting Chart on pages 30 and 31 if service becomes necessary.
- ☞ Include the model and serial numbers of your appliance when requesting service.
 - Proof of purchase such as sales receipt will be needed for warranty service.
- ☞ You can contact us at:

Maytag Appliances Sales Company
 Attn: CAIR Center
 P. O. Box 2370
 Cleveland, TN 37320-2370
 1-800-688-1120

In our continuing effort to improve the quality and performance of our cooking appliances, it may be necessary to make changes to the appliance without revising this manual.

*OK to print
M. L. L. 1/14/98*

WARNING: If the information in this manual is not followed exactly, a fire or explosion may result causing property damage, personal injury or death.

- Do not store or use gasoline or other flammable vapors and liquids in the vicinity of this or any other appliance.
- **WHAT TO DO IF YOU SMELL GAS:**
 - Do not try to light any appliance.
 - Do not touch any electrical switch; do not use any phone in your building.
 - Immediately call your gas supplier from a neighbor's phone. Follow the gas supplier's instructions.
 - If you cannot reach your gas supplier, call the fire department.
- Installation and service must be performed by a qualified installer, service agency or the gas supplier.



WARNING

- ALL RANGES CAN TIP AND CAUSE INJURIES TO PERSONS.
- INSTALL ANTI-TIP DEVICES PACKED WITH RANGE.
- FOLLOW ALL INSTALLATION INSTRUCTIONS.



WARNING: To reduce the risk of tipping of the appliance from abnormal usage or by excessive loading of the oven door, the appliance must be secured by a properly installed anti-tip device.

If the range is moved from the wall, be sure the anti-tip device is engaged when the range is replaced. Look underneath range to verify that one of the rear leveling legs is properly engaged in the bracket slot.

The anti-tip device secures the rear leveling leg to the floor when properly engaged. Also, be sure the range is properly re-installed.

IMPORTANT SAFETY INSTRUCTIONS

2

IMPORTANT SAFETY INSTRUCTIONS

The following instructions are based on safety considerations and must be strictly followed to eliminate the potential risks of fire, electric shock, or personal injury.

Have your appliance installed and properly grounded by a qualified installer according to the installation instructions. Have the installer show you the location of the gas shut off valve and how to shut it off in an emergency.

Always disconnect power to appliance before servicing.

To ensure proper operation and avoid possible injury or damage to unit do not attempt to adjust, repair, service, or replace any part of your appliance unless it is specifically recommended in this book. All other servicing should be referred to a qualified installer or servicer.

TO PREVENT FIRE OR SMOKE DAMAGE

Be sure all packing materials are removed from the appliance before operating it.

Keep area around appliance clear and free from combustible materials, gasoline, and other flammable vapors and materials.

If appliance is installed near a window, proper precautions should be taken to prevent curtains from blowing over burners.

NEVER leave any items on the cooktop. The hot air from the vent may ignite flammable items and may increase pressure in closed containers which may cause them to burst.

Many plastics are vulnerable to heat. Keep plastics away from parts of the appliance that may become warm or hot. Do not leave plastic items on the cooktop as they may melt or soften if left too close to the vent or a lighted surface burner.

Many aerosol-type spray cans are **EXPLOSIVE** when exposed to heat and may be highly flammable. Avoid their use or storage near an appliance.

To eliminate the hazard of reaching over hot surface burners, cabinet storage should not be provided directly above a unit. If such storage is provided, it should be limited to items which are used infrequently and which are safely stored in an area subjected to heat from an appliance. Temperatures may be unsafe for some items, such as volatile liquids, cleaners or aerosol sprays.

IN CASE OF FIRE

Turn off appliance and ventilating hood to avoid spreading the flame. Extinguish flame then turn on hood to remove smoke and odor.

Use dry chemical or foam-type extinguisher or baking soda to smother fire or flame. Never use water on a grease fire.

If fire is in the oven or broiler pan, smother by closing oven door.

If fire is in a pan on the surface burner, cover pan. Never attempt to pick up or move a flaming pan.

CHILD SAFETY

NEVER leave children alone or unsupervised near the appliance when it is in use or is still hot. **NEVER** allow children to sit or stand on any part of the appliance.

Children must be taught that the appliance and utensils in it can be hot. Let hot utensils cool in a safe place, out of reach of small children. Children should be taught that an appliance is not a toy. Children should not be allowed to play with controls or other parts of the unit.

CAUTION: NEVER store items of interest to children in cabinets above an appliance or on the backguard of a range. Children climbing on the appliance or on the appliance door to reach items could be seriously injured.

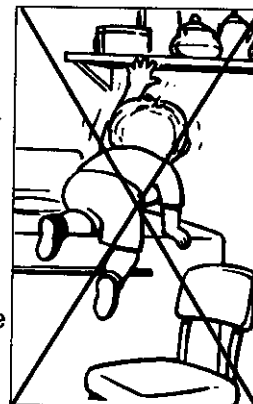

ABOUT YOUR APPLIANCE

NEVER use appliance as a space heater to heat or warm a room to prevent potential hazard to the user and damage to the appliance. Also, do not use the cooktop or oven as a storage area for food or cooking utensils.

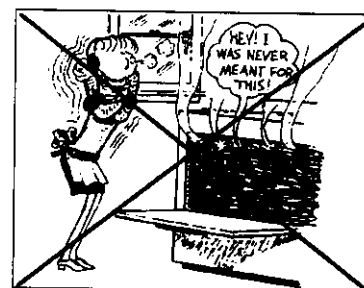

Do not obstruct the flow of combustion and ventilation air by blocking the oven vent or air intakes. Restriction of air flow to the burner prevents proper performance and increases carbon monoxide emission to unsafe levels.

3

IMPORTANT SAFETY INSTRUCTIONS

Avoid touching oven vent area while oven is on and for several minutes after oven is turned off. Some parts of the vent and surrounding area become hot enough to cause burns. After oven is turned off, do not touch the oven vent or surrounding areas until they have had sufficient time to cool.

WARNING: NEVER use appliance door or drawer, if equipped, as a step stool or seat as this may result in possible tipping of the appliance, damage to the appliance, and serious injury.

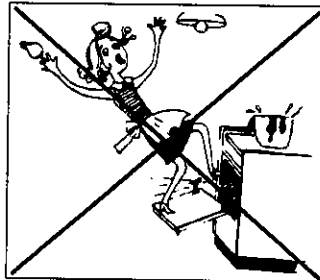

Do not touch a hot oven light bulb with a damp cloth as the bulb could break. Should the bulb break, disconnect power to the appliance before removing bulb to avoid electrical shock.

COOKING SAFETY

Always place a pan on a surface burner before turning it on. Be sure you know which knob controls which surface burner. Make sure the correct burner is turned on and that the burner has ignited. When cooking is completed, turn burner off before removing pan to prevent exposure to burner flame.

Always adjust surface burner flame so that it does not extend beyond the bottom edge of the pan. An excessive flame is hazardous, wastes energy and may damage the appliance, pan or cabinets above the appliance.

NEVER leave a surface cooking operation unattended especially when using a high heat setting or when deep fat frying. Boilovers cause smoking and greasy spillovers may ignite. Clean up greasy spills as soon as possible. Do not use high heat for extended cooking operations.

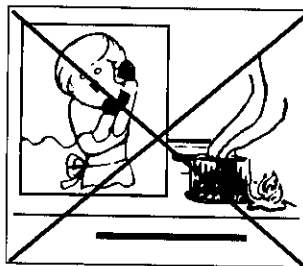

NEVER heat an unopened container on the surface burner or in the oven. Pressure build-up may cause container to burst resulting in serious personal injury or damage to the appliance.

Use dry, sturdy pot holders. Damp pot holders may cause burns from steam. Dish towels or other substitutes should never be used as pot holders because they can trail across hot surface burners and ignite or get caught on appliance parts.

Always let quantities of hot fat used for deep fat frying cool before attempting to move or handle.

Do not let cooking grease or other flammable materials accumulate in or near the appliance, hood or vent fan. Clean hood frequently to prevent grease from accumulating on hood or filter. When flaming foods under the hood turn the fan off as the fan may spread the flame.

NEVER wear garments made of flammable material or loose fitting or long hanging-sleeved apparel while cooking. Clothing may ignite or catch utensil handles.

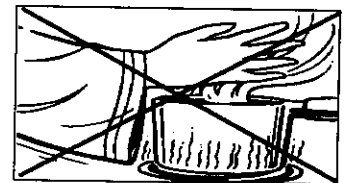

Always place oven racks in the desired positions while oven is cool. Slide oven rack out to add or remove food, using dry sturdy pot holders. Always avoid reaching into the oven to add or remove food. If a rack must be moved while hot, use a dry pot holder. Always turn the oven off at the end of cooking.

Use care when opening the oven door. Let hot air or steam escape before removing or replacing food.

PREPARED FOOD WARNING: Follow food manufacturer's instructions. If a plastic frozen food container and/or its cover distorts, warps, or is otherwise damaged during cooking, immediately discard the food and its container. The food could be contaminated.

IMPORTANT SAFETY INSTRUCTIONS

4

UTENSIL SAFETY

Use pans with flat bottoms and handles that are easily grasped and stay cool. Avoid using unstable, warped, easily tipped or loose handled pans. Also avoid using *SMALL* pans, especially small pans, with heavy handles, as they *CAN* be unstable and easily tip. Pans that are heavy to move when filled with food may also be hazardous.

Be sure utensil is large enough to properly contain food and avoid boilovers. Pan size is particularly important in deep fat frying. Be sure pan will accommodate the volume of food that is to be added as well as the bubble action of fat.

To minimize burns, ignition of flammable materials and spillage due to unintentional contact with the utensil, do not extend handles over adjacent surface burners. Always turn pan handles toward the side or back of the appliance, not out into the room where they are easily hit or reached by small children.

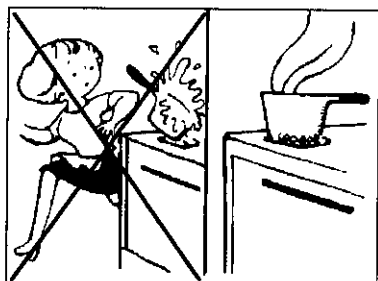

Never let a pan boil dry as this could damage the utensil and the appliance.

Follow the manufacturer's directions when using oven cooking bags.

Only certain types of glass, glass/ceramic, ceramic, or glazed utensils are suitable for cooktop or oven usage without breaking due to the sudden change in temperature.

This appliance has been tested for safe performance using conventional cookware. Do not use any devices or accessories that are not specifically recommended in this manual. Do not use eyelid covers for the surface units, stove top grills, or add-on oven convection systems. The use of devices or accessories that are not expressly recommended in this manual can create serious safety hazards, result in performance problems, and reduce the life of the components of the appliance.

CLEANING SAFETY

Turn off all controls and wait for appliance parts to cool before touching or cleaning them. Do not touch the burner grates or surrounding areas until they have had sufficient time to cool.

Clean appliance with caution. Use care to avoid steam burns if a wet sponge or cloth is used to wipe spills on a hot surface. Some cleaners can produce noxious fumes if applied to a hot surface.

SELF-CLEAN OVEN

Clean only parts listed in this manual. Do not clean door gasket. The door gasket is essential for a good seal. Care should be taken not to rub, damage, or move the gasket. Do not use oven cleaners of any kind in or around any part of the self-clean oven.

Before self-cleaning the oven, remove broiler pan, oven racks, and other utensils, and wipe off excessive spillovers to prevent excessive smoke or flare ups.

CAUTION: Do not leave food or cooking utensils, etc. in the oven during the self-clean cycle.

It is normal for the cooktop of the range to become hot during a self-clean cycle. Therefore, touching or lifting the cooktop during a clean cycle should be avoided.

IMPORTANT SAFETY NOTICE AND WARNING

The California Safe Drinking Water and Toxic Enforcement Act of 1986 (Proposition 65) requires the Governor of California to publish a list of substances known to the State of California to cause cancer or reproductive harm, and requires businesses to warn customers of potential exposures to such substances.

Users of this appliance are hereby warned that the burning of gas can result in low-level exposure to some of the listed substances, including benzene, formaldehyde and soot, due primarily to the incomplete combustion of natural gas or liquid petroleum (LP) fuels. Properly adjusted burners will minimize incomplete combustion. Exposure to these substances can also be minimized by properly venting the burners to the outdoors.

SAVE THESE INSTRUCTIONS

CLOCK, TIMER, OVEN CONTROL

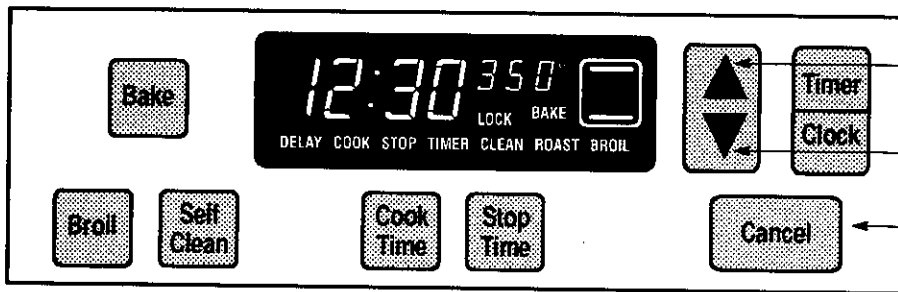

Press or press and hold these pads to enter time, oven temperature or to select HI or LO broil.

Press this pad to cancel all operations except the TIMER. The time of day will reappear in the display.

HOW TO SET CLOCK

1. Press CLOCK pad.
2. Press or press and hold ▲ or ▼ pad until correct time of day appears in display.

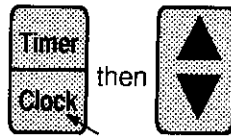

- Display will flash when power is supplied to unit.
- Clock time cannot be changed if oven is set for timed bake or delayed clean operation. Cancel the operation before setting the clock.

To recall time of day when another function is displayed: Press CLOCK pad.

CLOCK DISPLAY DISABLE FEATURE

If you prefer that the time of day is not displayed:

1. Press and hold **both** CLOCK and CANCEL pads for **3 seconds**.
2. Repeat step 1 to reactivate clock feature.

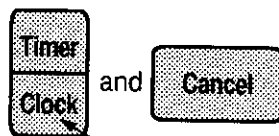

- When clock display is disabled, press CLOCK pad to recall time of day in the display for 4 seconds. Display will then blank.
- If a power failure occurs when the clock has been disabled, the display will not flash when power is restored.

HOW TO SET TIMER

1. Press TIMER pad.
2. Press or press and hold ▲ or ▼ pad until correct time appears in display.

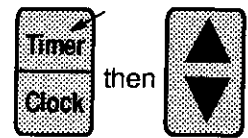

- The timer feature does not operate the oven.
- The timer can be set from 1 minute [0HR:01] up to 99 hours and 59 minutes [99:59].
- The timer will start automatically. Flashing colon indicates that the timer is in use. One long beep signals the end of the timer operation.

To cancel timer: Press and hold TIMER pad for **3 seconds**. Time of day will reappear in the display.

"END OF TIMER" BEEPS

You have a choice of three "end of timer" reminder beeps.

- **Option 1:** One beep then one beep every 30 seconds for the **next 5 minutes** or until canceled.
- **Option 2:** One beep then one beep every minute for the **next 12 hours** or until canceled.
- **Option 3:** One beep. There are no other beeps. (Default option.)

How to select the desired option:

1. Press and hold **both** TIMER and CANCEL pads for **3 seconds**.
 - A single beep will sound.
 - Display will show current option.
2. Press ▲ or ▼ pad to select the option number you wish.

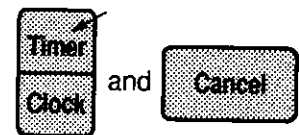

The current time of day will reappear in the display after 4 seconds.

CLOCK, TIMER, OVEN CONTROL

6

HOW TO SET OVEN TO BAKE OR ROAST

1. Press BAKE pad.
2. Press ▲ or ▼ pad until correct oven temperature appears in display.

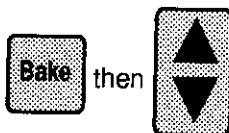

See page 8 for additional information.

HOW TO SET OVEN TO BROIL

1. Press BROIL pad.
2. Press ▲ or ▼ pad to select HI or LO broil.

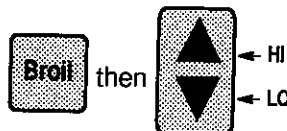

See page 10 for additional information.

HOW TO SET OVEN TO SELF-CLEAN

1. Close and lock oven door.
2. Press SELF-CLEAN pad.
3. Oven will automatically clean for 3 hours or, press ▲ or ▼ pad and select 2 to 4 hours.

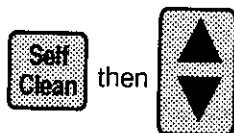

- Beeps will sound and "door" will appear in display if oven door is not properly locked.

See pages 19 and 20 for additional information.

12 HOUR ENERGY SAVER FEATURE

The 12 Hour Energy Saver feature automatically turns off the oven if it is accidentally left on for 12 hours.

To deactivate this feature so the oven will NOT turn off automatically at the end of 12 hours:

1. Press and hold CLOCK pad for 3 seconds.
2. Press ▲ or ▼ pad until 8888 appears in the display.

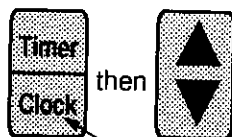

- Current time of day will reappear in the display after 4 seconds.
3. Repeat steps 1 and 2 to reactivate this feature.
 - 12 will appear in display to indicate the Energy Saver feature is reactivated.

HOW TO SET TIMED COOK OPERATION

1. Press COOK TIME pad and enter desired cooking time.

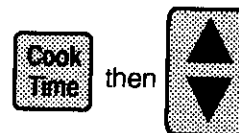

2. Press BAKE pad and enter oven temperature.

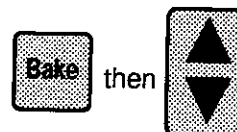

3. To delay the start of cooking:

Press STOP TIME pad and enter the time you wish the oven to turn off.

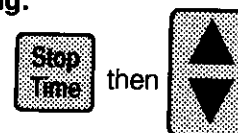

- Oven will automatically turn on and off at the preselected times. Beeps will signal the end of cooking.

See page 9 for additional information.

"END OF TIMED COOK" BEEPS

You have a choice of three "end of cooking" reminder beeps for the Automatic Oven Timer feature.

- **Option 1:** Four beeps then one beep every 30 seconds for the next 5 minutes or until CANCEL pad is pressed. (Default option.)
- **Option 2:** Four beeps then one beep every minute for the next 12 hours or until CANCEL pad is pressed.
- **Option 3:** Four beeps. There are no other beeps.

How to select the desired option:

1. Press and hold both COOK TIME and CANCEL pads for 3 seconds.



- A single beep will sound.
- Display will show current option.

2. Press ▲ or ▼ pad to select the option number you wish.



- The current time of day will reappear in the display after 4 seconds.

PILOTLESS IGNITION SYSTEM

Your range is equipped with pilotless ignition. Be sure all surface controls are set in the OFF position prior to supplying gas to the appliance.

IMPORTANT: When the appliance is first installed, the surface burners may be difficult to light due to air in the gas line. This may also occur if the appliance has been disconnected from the main gas supply or if it has not been used for several days or weeks.

To remove the air in the gas line, hold a lighted match next to the burner head and turn the knob on. When the burner lights, either adjust the knob to the desired flame size or turn the burner off.

Pilotless ignition uses a spark from the ignitor to light the burner. There are two ignitors for conventional surface burners. Each sealed burner has its own ignitor. Once the burner lights, turn the knob to the desired setting. The clicking sound will not stop until the knob is turned from the LITE position.

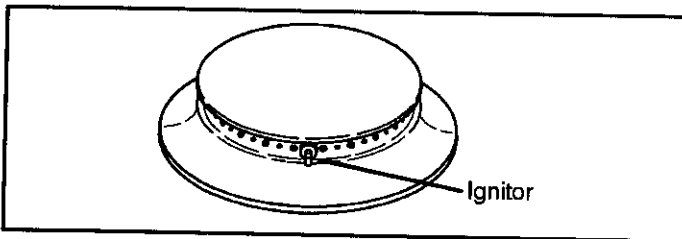

NOTE: The surface burner will not light if the ignitor is damaged, broken, soiled or wet. Also, the burner will not light if the small port beneath the ignitor is blocked. See page 23 for cleaning instructions.

LIGHTING SURFACE BURNERS

To prevent damage to the cooktop or pan, never operate surface burner without a pan in place, never allow a pan to boil dry and never operate a surface burner on HIGH for extended periods of time.

To light surface burner:

1. Place a pan on the burner grate.

NOTE: The burner flame may lift off the burner head and a "roaring" sound may be heard if a pan is not placed on the grate before lighting the burner.

2. Push in and turn knob to the LITE position.

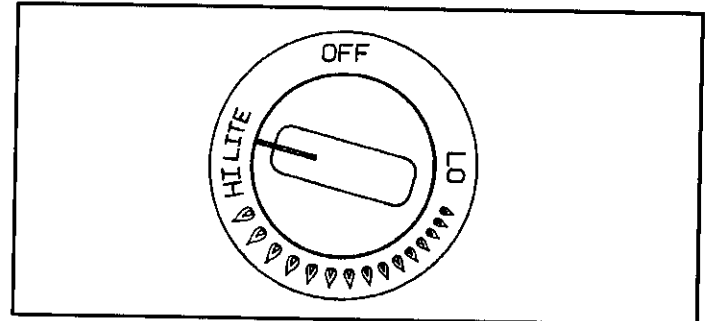

A clicking sound will be heard and the burner will light. When one burner is turned on, all ignitors will spark.

3. After the burner lights, turn the knob to the desired flame size. The ignitors will continue to spark until the knob is turned from the LITE position.

CAUTION: If the flame should go out during a cooking operation, turn the burner off. If gas has accumulated and a strong gas odor is detected, wait 5 minutes for the gas odor to disappear before relighting burner.

To light surface burner during a power failure:

1. Be sure all controls are in the OFF position.
2. Hold a lighted match to the desired surface burner head.
3. Push in and turn knob to the LITE position. The burner will then light.
4. Adjust the flame to the desired flame size.

CAUTION: When lighting the surface burner, be sure all of the controls are in the OFF position. Strike the match first and hold it in position before turning the knob to the LITE position.

SURFACE COOKING

8

SELECTING FLAME SIZE

Use a HIGH flame setting to quickly bring liquids to a boil or to begin a cooking operation. Then reduce to a lower setting to continue cooking. **Never leave food unattended when using a HIGH flame setting.**

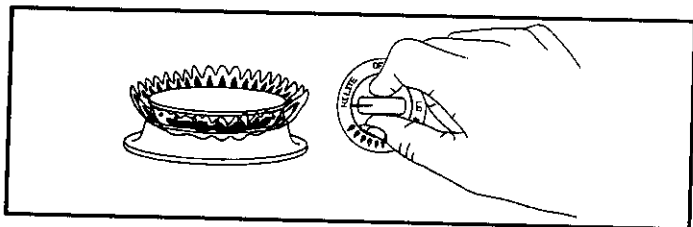

An intermediate flame size is used to continue a cooking operation. **Food will not cook any faster when a higher flame setting is used than needed to maintain a gentle boil.** Remember, water boils at the same temperature whether boiling gently or vigorously.

Use LO to simmer or keep foods at serving temperatures.

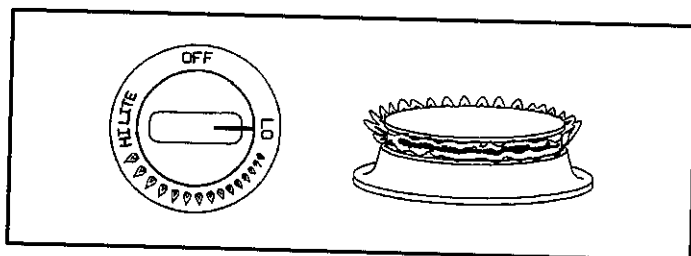

Some cooking may take place on the LO setting if the cooking utensil is covered. If food does boil on the LO setting, it is possible to reduce the heat by rotating the knob toward the OFF position.

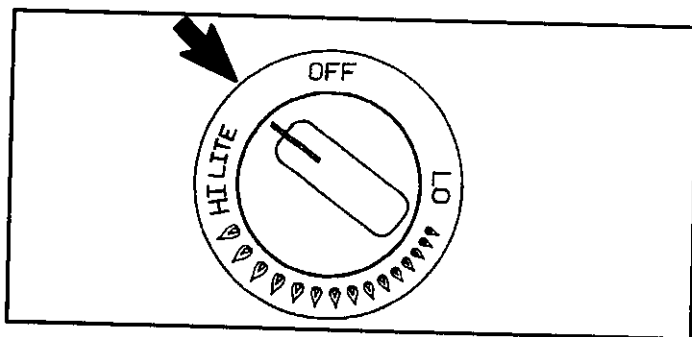

Be sure to adjust the knob so there is an adequate supply of gas to maintain a stable flame on the burner. Check to be sure burner is lit and the flame is stable.

ABOUT THE SURFACE BURNER FLAME

A properly adjusted burner with clean ports will light within a few seconds.

On natural gas, the flame will be blue with a deeper blue core; there should be no trace of yellow in the flame.

A yellow flame indicates an improper mixture of air/gas. This wastes fuel, so have a serviceman adjust the mixture if a yellow flame occurs.

On LP gas, some yellow tipping is acceptable. This is normal and adjustment is not necessary.

You may hear a "popping" sound on some types of gas when the surface burner is turned off. This is a normal operating sound of the burner.

ADJUSTING THE FLAME

Adjust the flame size so it does not extend beyond the edge of the cooking utensil. This is for personal safety and to prevent possible damage to the appliance, pan, or cabinets above the appliance. This also improves cooking efficiency.

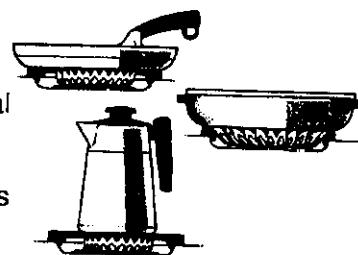

NOTE: If a knob is turned very quickly from the HI to the LO setting, the flame may go out, particularly if the burner is cold. If this occurs, turn the knob to the OFF position. Wait several seconds, then light the burner again.

CONVENTIONAL SURFACE BURNERS

Under no circumstances are the surface burner assemblies to be taken apart for cleaning. The surface burner assembly can be removed to clean the burner box area.

The two surface burner assemblies are secured in place during transportation with screws. Once the range is installed, these screws may be removed to allow quick and easy removal of the burner assemblies.

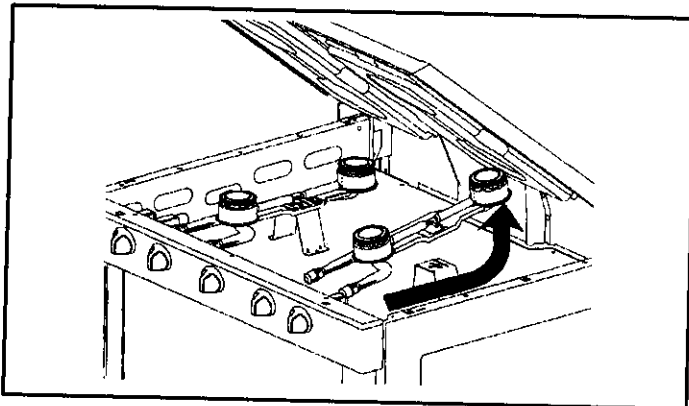

To remove: Allow the burner assembly to cool. Lift up cooktop. Grasp the burner assembly and rotate it slightly toward the left to release the two tabs on the assembly. Then lift the assembly and pull toward the back of the cooktop until the air shutter ends on the assembly release from the valves.

To replace: Insert the air shutter ends on the burner assembly over the valves and lower the assembly into place. Be sure to secure the two tabs on the burner assembly into the two slots on the burner support bracket which is mounted to the burner box bottom. (**NOTE:** If the tabs are not properly inserted into the slots, the assembly may rock and the burners may not light properly.)

SEALED SURFACE BURNERS

The porcelain on the burner is durable but over time and with use may gradually lose its shine.

The sealed surface burners are secured to the cooktop and are NOT designed to be removed by the consumer.

Select models feature one or two special SUPER HIGH SPEED sealed burners located at the right-front and left-rear. Use these burners to quickly bring water to a boil and when using larger pans. See information on rating plate, located on the lower range front frame behind the broiler door or lower panel, to determine if your appliance features these burners.

Clean burner cap after each use especially if a spillover occurs. A soiled burner may result in improper ignition or an uneven flame. When cleaning the sealed surface burner, use care to prevent damage to the ignitor. If a cleaning cloth should catch the ignitor, it could be damaged or broken.

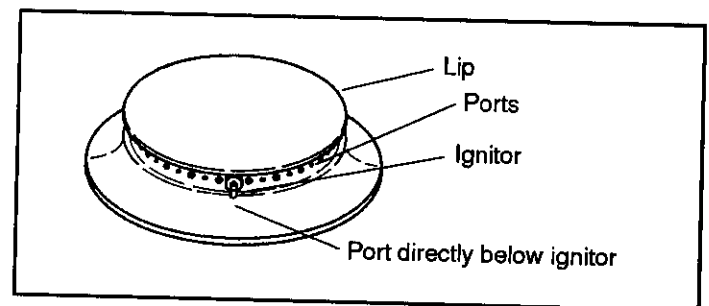

The surface burner will not light if the ignitor is damaged, broken, soiled or wet. The burner will also not light if the ports, especially the small port located directly below the ignitor, are blocked.

COOKWARE CONSIDERATIONS

Cookware which extends more than two inches beyond the grate, rests on two grates, or touches the cooktop may cause a build up of heat which may result in damage to the burner grate, burner or cooktop.

Cookware, such as a wok with a support ring, which restricts air circulation around the burner will cause heat to build up and may result in damage to the burner grate, burner or cooktop.

Foods cook faster when the cookware is covered because more heat is retained. Lower the flame size when cookware is covered.

The cooking performance is greatly affected by the type of cookware used. Proper cookware will reduce cooking times, use less energy and produce more even cooking results. For best results use a heavy gauge metal pan with a smooth flat bottom, straight sides and a tight fitting lid.

Cookware with uneven, warped, or grooved bottoms do not make good contact with the heating surface, will reduce heat conductivity and result in slower, less even heating.

To determine the flatness of the bottom of a pan, place the edge of a ruler across the bottom of the utensil. Hold it up to the light. Little or no light should be visible under the ruler.

COOKWARE MATERIAL

The pan material determines how evenly and quickly heat is conducted from the heat source to the food. Some widely used pan materials are:

Aluminum – excellent heat conductor. Some foods will cause it to darken or pit. Often used as a bottom coating to improve the heating of other pan materials.

Copper – excellent heat conductor. Discolors easily, requires constant polishing. Often used as a bottom coating to improve the heating of other pan materials.

Stainless Steel – slow conductor of heat. Develops hot spots and produces uneven cooking results. Durable, attractive, easy to clean and stain resistant. Will distribute heat better if other metals (aluminum or copper) are combined or sandwiched together as a bottom coating.

Cast Iron – slow heat conductor. Cooks evenly once temperature is reached. Heavy. Needs seasoning to make cleaning easier and to prevent sticking and rusting.

Glass – slow heat conductor. Easy to clean. Some types may only be used in the oven.

Porcelain Enamel – glass-like substance fused to metal. Heating characteristics depend on base material. Easy to clean.

CANNING

Acceptable water-bath or pressure canners should not be oversized and should not rest on two burner grates. They should also have flat bottoms.

When canning, use the HI setting just until the water comes to a boil or pressure is reached in a pressure canner, then reduce to a setting that maintains the pressure or a boil.

Prolonged use of the HI setting, the use of incorrect canning utensils, or the use of improper canning techniques may produce excessive heat and result in permanent damage to the appliance.

NOTE: For additional canning information contact your local County Extension Office. Or, contact Alltrista Consumer Products Company, marketer of Ball brand home canning products at 800-240-3340 or write: Alltrista Corp., Consumer Affairs Dept., P.O. Box 2729, Muncie, IN 47307-0729.

PILOTLESS IGNITION SYSTEM

Be sure oven control is set in the OFF position prior to supplying gas to the appliance.

Your appliance features pilotless ignition. A glo bar will light the oven burner. With this type of ignition system, the oven will not operate during a power failure or if the oven is disconnected from the wall outlet. **No attempt should be made to operate oven during a power failure.**

OVEN BURNER

The size and appearance of a properly adjusted oven burner flame should be as shown:

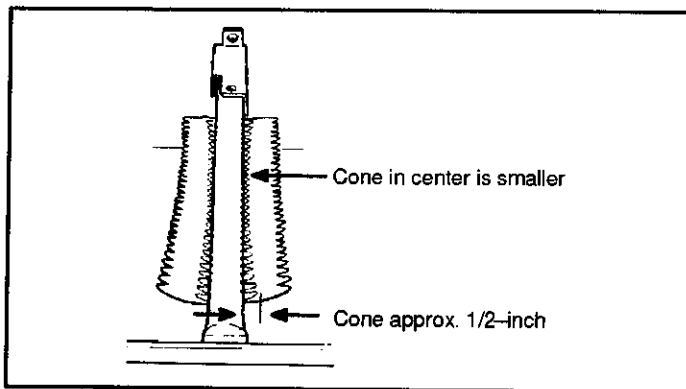

The oven temperature is maintained by cycling the burner on and off. After the oven temperature has been set, there will be about a 45 second delay before the burner ignites. This is normal and no gas escapes during this delay.

During the clean cycle, and some extended oven cooking operations, you may hear a "popping" sound when the burner cycles off. This is a normal operating sound of the burner.

OVEN VENT

The oven vent is located at the base of the backguard. When the oven is in use, this area may feel warm or hot to the touch. To prevent baking problems, do not block the vent opening in any way. Also, do not place plastics near the vent opening as heat from the vent could distort or melt the plastic.

GENERAL INFORMATION

- Do not lock oven door during a bake or broil operation.
 - If door is locked, beeps will sound and "door" will flash in display when the BAKE or BROIL pad is pressed.

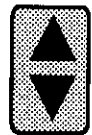

- If door is locked during a cooking operation, the operation will be canceled and, if oven temperature is above 400°F, the internal locking mechanism will engage. The door can not be unlocked and opened until the oven has cooled.
- The oven burner cycles on and off to maintain the oven temperature for baking. The broil burner turns on for broiling and cycles on and off to maintain the broil temperature.
- If you press BAKE or BROIL pad and do not set an oven temperature or broil setting within 30 seconds, the program will automatically cancel. The time of day will reappear in the display.
- To change oven temperature during cooking, press ▲ or ▼ pad to select new temperature.

**OVEN CONTROL LOCK-OUT FEATURE**

The Oven Control Lock-Out feature prevents the oven from being turned on. This is especially helpful when cleaning the control panel.

To activate:

1. Press and hold STOP TIME and CANCEL pads for 3 seconds.



2. Repeat step 1 to deactivate this feature.

When this feature is activated, OFF will appear in the temperature display for 15 seconds whenever any pad is pressed.



NOTE: The current time of day will remain in the display when this feature is activated.

HOW TO SET OVEN TO BAKE OR ROAST

1. Press BAKE pad.

- BAKE will flash in display.
- 000 will light in display.



2. Press or press and hold ▲ or ▼ pad to select oven temperature.

- 350° will light when either pad is pressed.
- Oven temperature can be set from 100° to 550°.



3. There will be a 4 second delay before the oven turns on. When the oven turns on:

- PREHEAT indicator will light in the display.
- The BAKE symbol will light in display.
- 100° or the actual oven temperature will appear in display.
- The temperature will increase by 5° until the oven reaches the preselected temperature.
- Press the BAKE pad to recall the preselected temperature during preheat.

PREHEAT
INDICATOR

BAKE
SYMBOL



4. Allow 8 to 15 minutes for the oven to preheat.

- A single beep will indicate that the oven has preheated.
- The PREHEAT indicator will turn off.



5. Place food in the oven.

6. Check cooking progress at the minimum cooking time. Cook longer if needed.

NOTE: See pages 13, 14, and 15 for additional information on baking and roasting.

7. Press CANCEL pad and remove food from the oven.

- Time of day will reappear in display.



NOTE: If you forget to turn off the oven, it will automatically turn off at the end of 12 hours. If you wish to deactivate this energy saving feature, see page 6.

GENERAL BAKING TIPS

Oven characteristics: Each oven has its own personal baking characteristics. Therefore, do not expect that your new oven will perform exactly like your previous oven. You may find that the cooking times, oven temperatures, and cooking results differ somewhat from your previous range. Allow a period of adjustment.

Use a reliable recipe and accurately measure fresh ingredients. **Carefully follow directions** for oven temperature and cooking time.

Use the correct rack position. Baking results may be affected if the wrong rack is used. For optimum results, bake foods on one rack. Select a rack position that locates the food in the center of the oven. If baking on two racks, select rack positions #2 and 4, #1 and 4 or #2 and 5.

- Top browning may be darker if food is located toward the top of the oven.
- Bottom browning may be darker if food is located toward the bottom of the oven.
- When using two racks for baking, allow enough space between the racks for proper air circulation. Browning and cooking results will be affected if air flow is blocked.

Cookware material plays an important part in baking results. Always use the type and size of pan called for in the recipe. Cooking times or cooking results may be affected if the wrong size is used.

- **A shiny metal pan** reflects heat away from the food. This type of pan produces lighter browning and a softer crust. Use shiny pans for baking cakes or cookies.
- **A dark metal, dull, anodized or satin-finish pan** absorbs heat and produces darker browning with a crisper crust. Use dark pans for pies, pie crusts or bread.
- For optimum baking results, bake cookies and biscuits on a **flat** cookie sheet. If the pan has sides, such as a jelly roll pan, browning may not be even.

- If using **heat-proof glassware**, or **dark pans such as Baker's Secret or Wilton** reduce the oven temperature by 25°F except when baking pies or bread. Use the same baking time as called for in the recipe.

Allow hot air to flow freely through the oven for optimum baking results. Improper placement of pans in the oven will block air flow and may result in uneven browning. For optimum browning and even cooking results:

- Do not crowd a rack with pans. Never place more than one cookie sheet, one 13x9x2-inch cake pan or two 9-inch round cake pans on one rack.
- Stagger pans when baking on two racks so one pan is not directly over another pan.
- Allow two inches between the pan and the oven walls.

Check the cooking progress at the minimum time recommended in the recipe. If necessary, continue checking at intervals until the food is done. If the oven door is opened too frequently, heat will escape the oven; this can affect baking results and wastes energy.

If you add additional ingredients or alter the recipe, expect cooking times to increase or decrease slightly.

PREHEATING

Preheating is necessary for baking. Allow about 8 to 15 minutes for the oven to preheat. A single beep will indicate that the oven is preheated. It is not necessary to preheat for roasting.

Selecting a temperature higher than desired will NOT preheat the oven any faster, and may have a negative effect on baking results.

USE OF ALUMINUM FOIL

Do not cover an entire rack with foil or place foil directly under cookware. To catch spillovers, place a piece of foil, a little larger than the pan, on the rack below the pan. Do not place foil on the oven bottom.

COMMON BAKING PROBLEMS AND WHY THEY HAPPEN

PROBLEM	POSSIBLE CAUSES
Cakes are uneven.	<ul style="list-style-type: none"> • Pans too close or touching each other or oven walls. • Batter uneven in pans. • Temperature set too low or baking time too short. • Oven not level. • Undermixing. • Too much liquid.
Cake high in middle.	<ul style="list-style-type: none"> • Temperature set too high. • Baking time too long. • Overmixing. • Too much flour. • Pans touching each other or oven walls. • Incorrect rack position.
Cake falls.	<ul style="list-style-type: none"> • Too much shortening or sugar. • Too much or too little liquid. • Temperature set too low. • Old or too little baking powder. • Pan too small. • Oven door opened frequently. • Added incorrect type of oil to cake mix. • Added additional ingredients to cake mix or recipe.
Cakes, cookies, biscuits don't brown evenly.	<ul style="list-style-type: none"> • Incorrect rack position. • Oven door not closed properly. • Door gasket not sealing properly or properly attached to door. • Incorrect use of aluminum foil. • Oven not preheated. • Pans darkened, dented or warped. <p>For optimum results, bake on one rack. If baking cakes on two racks, place pans toward the front of the oven on the upper rack and toward the back of the oven on the lower rack.</p>
Cakes, cookies, biscuits too brown on bottom.	<ul style="list-style-type: none"> • Oven not preheated. • Pans touching each other or oven walls. • Incorrect rack position. • Incorrect use of aluminum foil. • Placed 2 cookie sheets on one rack. • Used glass, dark, stained warped or dull finish metal pans. (Use a shiny cookie sheet.) <p>Follow cookware manufacturer's instructions for oven temperature. Glassware and dark cookware such as Ecko's Baker's Secret may require lowering the oven temperature by 25°F.</p>
Cakes don't brown on top.	<ul style="list-style-type: none"> • Incorrect rack position. • Temperature set too low. • Overmixing. • Too much liquid. • Pan size too large or too little batter in pan. • Oven door opened too often.
Excessive shrinkage.	<ul style="list-style-type: none"> • Too little leavening. • Overmixing. • Pan too large. • Temperature set too high. • Baking time too long. • Pans too close to each other or oven walls.
Uneven texture.	<ul style="list-style-type: none"> • Too much liquid. • Undermixing. • Temperature set too low. • Baking time too short.
Cakes have tunnels.	<ul style="list-style-type: none"> • Not enough shortening. • Too much baking powder. • Overmixing or at too high a speed. • Temperature set too high.
Cake not done in middle.	<ul style="list-style-type: none"> • Temperature set too high. • Pan too small. • Baking time too short. <p>If additional ingredients were added to mix or recipe, expect cooking time to increase.</p>
Pie crust edges too brown.	<ul style="list-style-type: none"> • Temperature set too high. • Pans touching each other or oven walls. • Edges of crust too thin; shield with foil.
Pies don't brown on bottom.	<ul style="list-style-type: none"> • Used shiny metal pans. • Temperature set too low. • Incorrect rack position. • Some frozen pies should be placed on a cookie sheet, check package directions.
Pies have soaked crust.	<ul style="list-style-type: none"> • Temperature too low at start of baking. • Filling too juicy. • Used shiny metal pans.

ROASTING

Roasting is the method for cooking large, tender cuts of meat uncovered, without adding moisture. Most meats are roasted at 325°F. It is not necessary to preheat the oven. Place the roasting pan on either of the two lowest rack positions.

Use tender cuts of meat weighing three pounds or more. Some good choices are: Beef rib, ribeye, top round, high quality tip and rump roast, pork loin roast, leg of lamb, veal shoulder roast and cured or smoked hams.

Season meat, if desired, either before or after roasting. Rub into the surface of the roast if added before cooking.

Place the meat fat-side-up on a rack in a shallow roasting pan. Placing the meat on a rack holds it out of the drippings, thus allowing better heat circulation for even cooking. As the fat on top of the roast melts, the meat is

basted naturally, eliminating the need for additional basting.

The cooking time is determined by the weight of the meat and the desired doneness. For more accurate results, use a meat thermometer. Insert it so the tip is in the center of the thickest part of the meat. It should not touch fat or bone.

Remove the roast from the oven when the thermometer registers the desired internal temperature.

NOTE: For more information about food safety, call USDA's Meat & Poultry Hotline at 1-800-535-4555. For cooking information call or write to the National Cattle-men's Beef Association, 444 North Michigan Avenue, Chicago, Illinois 60611, or call 1-800-368-3138.

ROASTING CHART (Thawed meats only)

Cut of Meat	Approximate Weight (pounds)	Oven Temperature in °F	Internal Temperature	Approximate* Roasting Time (min. per lb.)
Beef				
Rib Roast (cut-side-down)	4 to 8	325°F	145°F (medium/rare) 160°F (medium)	25 - 35 30 - 35
Rib Eye Roast	4 to 6	350°F	145°F (medium/rare) 160°F (medium)	25 - 35 30 - 35
Loin Tenderloin Roast	2 to 3	400°F	145°F (medium/rare)	20 - 30
Pork, Fresh				
Shoulder Blade Roast, (boneless)	4 to 6	325°F	160°F	35 - 45
Shoulder Blade Roast	4 to 6	325°F	160°F	30 - 40
Loin Blade or Sirloin Roast	3 to 4	325°F	160°F	35 - 40
Boneless Pork Loin	6 to 8	325°F	160°F	25 - 35
Pork, Smoked				
Ham, Half (fully cooked)**	5 to 7	325°F	140°F	25 - 35
Ham, Half (cook-before-eating)	5 to 7	325°F	140°F	35 - 45
Poultry				
Turkey, unstuffed***	12 to 16 16 to 20 20 to 24	325°F 325°F 325°F	180°-185°F 180°-185°F 180°-185°F	18 - 20 16 - 18 14 - 16
Turkey, Breast	3 to 8	325°F	180°F	30 - 40
Chicken, Fryer	2 1/2 to 3 1/2	350-375°	180°F	20 - 25
Chicken, Roaster	4 to 6	350-375°F	180°F	20 - 25
Lamb				
Leg (boneless)	2 to 3	325°F	160°F 170°F	35 - 40 40 - 45
Whole Leg	5 to 7	325°F	160°F	30 - 35

* Cooking times are approximate and may vary depending on the shape of the roast. A meat thermometer is the most accurate way to determine doneness.

** Add water and follow package directions.

*** Stuffed turkey requires additional roasting time. Shield legs and breast with foil to prevent overbrowning and drying of skin.

AUTOMATIC OVEN TIMER CONTROL



CAUTION

- Highly perishable foods such as dairy products, pork, poultry, seafood or stuffing are not recommended for a delayed cooking operation.
- Baking is not recommended because preheating is required.

The clock must be functioning and set at the correct time of day for this feature to operate properly.

The Automatic Oven Timer Control is used to turn the oven on and off at a preset time of day. This feature can be used for either oven cooking or self-cleaning.

- **Immediate start:** Oven turns on immediately and automatically turn off at a preset time.
- **Delayed start:** Delays the start of cooking or cleaning and automatically turns off at a preset time.

Cook time can only be set for up to 11 hours and 59 minutes (11:59).

HOW TO SET TIMED COOK OPERATION

1. Press COOK TIME pad.

- 0:00 will light in display.
- COOK TIME will flash in display.



2. Press or press and hold ▲ or ▼ pad to enter cooking time.

3. Press BAKE pad.

- 000 will light in display.
- BAKE will flash in display.



4. Press or press and hold ▲ or ▼ pad to enter oven temperature. **NOTE:** Beeps will sound if temperature is not set within 4 seconds.

5. IF YOU WISH TO DELAY THE START OF COOKING (if not, skip to #6):

a. Press STOP TIME pad.

- STOP TIME will flash in display.

b. Press or press and hold ▲ or ▼ pad to enter time of day you wish oven to turn off.



c. Press CLOCK pad.

- Time of day will reappear in display.

d. DELAY BAKE will remain in display to show the oven is set for a delayed cook operation.



6. When the oven turns on, the oven temperature and the BAKE symbol will light in display.

NOTE: It is not necessary to set a start time. Control will determine when to turn the oven on based on the cook time you set.

7. Oven will automatically turn off. Four beeps will sound and END will light in display. A beep will sound every 30 seconds for the next 5 minutes.

NOTE: See page 6 if you wish to change the end of cooking reminder beeps.

8. Press CANCEL pad. Beeps will stop and time of day will reappear in display. Remove food from oven.



HOW TO SET OVEN TO BROIL

1. Press BROIL pad.

- BROIL will flash in display.
- 000 will light in display.



2. Press the ▲ pad to select HI (high) broil or the ▼ pad to select LO (low) broil.

- Select HI broil for normal broiling.
- Select LO broil for low temperature broiling of longer cooking foods such as poultry.

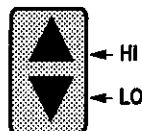

3. There will be a 4 second delay before the oven turns on. When the oven turns on:

- The BROIL symbol will light in display.

BROIL SYMBOL



4. Place food in the oven. Oven door is closed for broiling.

5. Turn meat once about half way through cooking.

6. Press CANCEL pad. Remove food and broiler pan from the oven.

- Time of day will reappear in display.

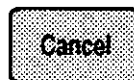

BROILING TIPS

Broiling is a method of cooking tender meats by direct heat. The cooking time is determined by the distance between the meat and the broil burner, the desired degree of doneness and the thickness of the meat.

Broiling requires the use of the broiler pan and insert. The broiler insert must be in place to allow fat and liquid to drain to the pan below to prevent spatters, smoke and flare-ups. Improper use may cause grease fires.

For easier clean up, line the broiler pan with foil and spray the insert with a non-stick vegetable spray. Do not cover

the broiler insert with aluminum foil as this prevents fat from draining into pan below.

Trim excess fat and slash remaining fat to help keep meat from curling and to reduce smoking and spattering. Season meat after cooking.

Place oven rack in the correct rack position when oven is cool. For darker browning, place meat closer to the broil burner. Place meat further down if you wish meat to be well done or if excessive smoking or flaring occurs.

See Care and Cleaning Chart on page 21 for instructions on cleaning the broiler pan and insert.

BROILING CHART

TYPE OF MEAT	RACK POSITION*	DONENESS	TOTAL TIME (MINUTES)**
BACON	#4	Well Done	6 to 10
BEEF STEAKS 1-inch thick	#4 #4	Medium Well Done	15 to 20 20 to 25
CHICKEN Pieces	#3 or #4	Well Done	LO BROIL 30 to 45
FISH Fillets	#4	Flaky	8 to 12
Steaks, 1-inch thick	#4	Flaky	12 to 15
GROUND BEEF PATTIES 3/4-inch thick	#4	Well Done	15 to 20
HAM SLICE , precooked 1/2-inch thick	#4	Warm	8 to 12
PORK CHOPS 1-inch thick	#4	Well Done	20 to 25

* The top rack position is position #5.

** Broiling times are approximate and may vary depending on the meat.

HOW TO SET OVEN FOR A CLEAN CYCLE

1. Move door lock lever to locked position.



2. Press SELF-CLEAN pad.

- 3:00 will light in display.
- CLEAN will flash in display.
- If door is not locked, beeps will sound and "door" will flash in display. Lock door.



3. Press ▲ or ▼ pad to select clean time.

- You can select from 2 up to 4 hours.
- Oven will automatically clean for 3 hours. Or,
 - Select 2 hours for light soil.
 - Select 4 hours for heavy soil.



4. IF YOU WISH TO DELAY THE START OF CLEANING (if not, skip to #5):

- Press STOP TIME pad.
- Press ▲ or ▼ pad to select the time of day you wish the oven to turn off.
- Press CLOCK pad and time of day will reappear in display.
- DELAY CLEAN will remain in display to show the oven is set for delayed clean operation.



then



5. When the oven turns on, CLEAN and the CLEAN symbol will light in display.

- LOCK will light in display when oven heats to 400°.
- Internal lock will engage. Door cannot be unlocked and opened when LOCK is displayed.

CLEAN SYMBOL



6. About one hour after the clean cycle ends, the LOCK indicator will turn off. The oven door can be unlocked and opened.



TO CANCEL CLEAN CYCLE:

- Press CANCEL pad.
- If LOCK is NOT displayed, unlock and open oven door.
If LOCK is displayed, allow oven to cool about one hour then unlock and open oven door.



INTERNAL LOCK IS STILL ENGAGED.
DOOR CANNOT BE UNLOCKED
UNTIL LOCK IS NO LONGER
DISPLAYED.

CAUTION

- It is normal for parts of the range to become hot during a clean cycle.
- Avoid touching cooktop, door, window, or oven vent area during a clean cycle.
- To prevent damage to oven door, do not attempt to unlock the door when the LOCK indicator is displayed.
- It is normal for excessive flare-ups and smoking to occur during cleaning if the oven is heavily soiled.

BEFORE CLEAN CYCLE

- Remove pans, broiler pan, and oven racks. Racks may discolor and not slide easily after cleaning.
- Clean oven frame and door frame. These areas are not exposed to cleaning temperatures; soil may bake on during clean cycle.
- To prevent damage, do not clean gasket located on oven door. Gasket seals in heat during the clean cycle.
- To prevent excessive smoke or flare-ups, wipe up excess grease or spillovers from oven bottom.
- Porcelain is acid resistant, not acid proof and may discolor during the clean cycle. To prevent or reduce discoloration, wipe up sugar or acid spills (lemon, milk, barbecue sauce, cheese).

DURING CLEAN CYCLE

- As oven heats, the LOCK indicator will light in the display. At this point, the door can not be unlocked and opened.
- To prevent damage to door or lock lever, do not force door open when the LOCK indicator is displayed.
- Some smoke and odor may be detected the first few times the oven is cleaned. This is normal and will lessen in time.
- Smoke may occur if oven is heavily soiled or if broiler pan was left in oven.
- As oven heats, you may hear sounds of metal parts expanding and contracting. This is normal and will not damage oven.

AFTER CLEAN CYCLE

- The LOCK indicator will turn off about one hour after clean cycle ends. The door can be unlocked and opened. Use care as oven may still be hot.
- A gray powdery ash may remain on the oven bottom or walls. This is normal. Use a damp cloth to remove ash.
- If soil remains, the clean cycle may not have been long enough.
- Wipe oven racks with a small amount of vegetable oil if racks do not slide easily after clean cycle.
- Clean around oven vent opening if there is a deposit from the fumes vented during cleaning.
- Fine lines may appear in the porcelain. This is normal and results from the heating and cooling of the finish. This will not affect oven performance.
- A white discoloration may appear after cleaning if acid soils (milk, tomato, lemon, etc.) or sugary soils were not wiped up before the clean cycle. This discoloration is normal and will not affect the performance of the clean cycle.

CLEANING TIPS

- Turn off oven light before cleaning as the light may burn out during a clean cycle.
- Clean oven regularly rather than allowing soil to build-up.
- Do not use oven cleaners in, on, or around any part of the range as they will damage the finish or parts.



- Be sure appliance is off and all parts are cool before handling or cleaning. This is to avoid damage and possible burns.
- If a part is removed, be sure it is correctly replaced.
- To prevent staining or discoloration, clean appliance after each use.

CLEANING CHART

PARTS	CLEANING AGENTS	CLEANING PROCEDURES
Broiler pan and insert (select models)	<ul style="list-style-type: none"> • Soap and water • Plastic or soap filled scouring pad • Dishwasher 	<p>Never cover insert with aluminum foil as this prevents the fat from draining to pan below.</p> <ol style="list-style-type: none"> 1. Remove from oven after use. Cool then pour off grease. 2. Place soapy cloth over insert and pan; let soak to loosen soil. 3. Wash in warm soapy water. Use soap filled scouring pad to remove stubborn soil. 4. Broiler pan and insert can be cleaned in the dishwasher.
Burner box (conventional surface burners only)	<ul style="list-style-type: none"> • Soap and water • Paste of baking soda and water • Non-abrasive plastic pad or sponge • Liquid cleaner • Glass cleaner 	<p>NOTE: Sealed burner cooktop does not lift up.</p> <ol style="list-style-type: none"> 1. Burner box, for cooktops with conventional burners, is located under lift-up cooktop. 2. Clean frequently to remove spillovers. If soil is not removed and is allowed to accumulate, it may damage the finish. 3. To clean remove grates and surface burners and clean with soap and water, rinse and dry.
Control knobs	<ul style="list-style-type: none"> • Soap and water • Mild liquid sprays • Glass cleaners 	<p>For ease of cleaning, turn off knob and remove by pulling forward.</p> <ol style="list-style-type: none"> 1. Wash, rinse, and dry. Do not use abrasive cleaning agents as they may scratch the finish and remove the markings. 2. Turn on each element to be sure knobs have been correctly replaced.
Drip bowls, chrome (select models)	<ul style="list-style-type: none"> • Soap and water • Plastic scouring pads • Mild abrasive cleaners • Flitz Metal Polish 	<p>Do not cover drip bowls with aluminum foil.</p> <p>NOTE: Bowls can permanently discolor over time, if exposed to excessive heat, or if soil is allowed to bake on. The discoloration will not affect the cooking performance.</p> <ol style="list-style-type: none"> 1. After each use, wash, rinse and dry. 2. If heavily soiled, gently scrub with plastic scouring pad. If soil is allowed to burn on, it may be impossible to remove. 3. A non-abrasive metal polish such as Flitz may be used to help remove blue/gold heat stains. Flitz is available in many automotive supply and hardware stores. These stains are caused by overheating, and normally occur over a period of time. They are usually permanent. Follow package directions.

CARE AND CLEANING CHART

22

PARTS	CLEANING AGENTS	CLEANING PROCEDURES
Enamel, painted <ul style="list-style-type: none"> • Oven door • Side panels • Storage drawer or lower panel 	<ul style="list-style-type: none"> • Soap and water • Mild liquid cleaner • Glass cleaner 	<p>NOTE: Use dry towel or cloth to wipe up spills, especially acid (milk, lemon juice, fruit, mustard, tomato sauce) or sugary spills. Surface may discolor or dull if soil is not immediately removed. This is especially important for white surfaces.</p> <ol style="list-style-type: none"> 1. When cool, wash with warm soapy water, rinse and dry. Never wipe a warm or hot surface with a damp cloth as this may damage the surface and may cause a steam burn. 2. For stubborn soil, use mildly abrasive cleaning agents such as baking soda paste or Bon Ami. 3. Do not use abrasive, caustic or harsh cleaning agents such as steel wool pads or oven cleaners. These products will scratch or permanently damage the surface.
Glass <ul style="list-style-type: none"> • Oven window 	<ul style="list-style-type: none"> • Soap and water • Glass cleaner • Paste of baking soda and water 	<p>To prevent staining of the oven window, avoid using excessive amounts of water which may seep under or behind glass.</p> <ol style="list-style-type: none"> 1. Wash with soap and water. Remove stubborn soil with paste of baking soda and water. Rinse with clear water and dry. 2. Do not use abrasive materials such as scouring pads, steel wool or powdered cleaning agents. They will damage glass.
Grates	<ul style="list-style-type: none"> • Soap and water • Non-abrasive plastic pad 	<p>NOTE: Never operate burner without a grate in place. To protect the porcelain finish on the grate from excessive heat, never operate surface burner without a cooking utensil on the grate. It is normal for grates to lose their shine over a period of time.</p> <ol style="list-style-type: none"> 1. Grates are made of porcelain-coated steel. They can be cleaned at the sink with soap and water or in the dishwasher. 2. To clean baked on soil, place a damp soapy paper towel over the grate and let stand for 30 minutes. Use a non-abrasive plastic pad to scour stubborn soil.
Metal finishes such as brushed aluminum, or chrome <ul style="list-style-type: none"> • Backguard • Cooktop • Manifold panel • Oven door • Storage door • Trim parts 	<ul style="list-style-type: none"> • Soap and water • Glass cleaner • Plastic or non-abrasive pad or sponge 	<ol style="list-style-type: none"> 1. Wash with soap and water or a glass cleaner and a soft cloth. 2. To prevent scratching or dulling of the finish, do not use mildly abrasive, abrasive, or harsh cleaners, or caustic cleaners such as oven cleaners. 3. To clean brushed aluminum: Use only soap and water or a soft cloth and glass cleaner to prevent scratching or dulling of the finish. 4. To clean brushed chrome cooktop or door: <ul style="list-style-type: none"> • Use a paste of baking soda and water and a soft cloth. • Rub with the grain to prevent scratching, dulling or streaking of the finish. • Use a soft cloth and mineral oil to restore luster or to remove fingerprints or smudges. • Clean with an automotive chrome cleaner or polisher.
Oven interior		<p>Porcelain enamel is acid resistant, not acid proof. Therefore, when cool, wipe up sugary or acid spills (milk, fruit, tomato, etc.) as they occur. See pages 19-20 for self-clean oven.</p>
Oven racks	<ul style="list-style-type: none"> • Soap and water • Plastic scouring pad • Cleansing powders • Soap-filled scouring pad 	<ol style="list-style-type: none"> 1. Clean with soapy water. 2. Remove stubborn soil with cleansing powder or soap-filled scouring pad. Rinse and dry. <p>Racks will permanently discolor and may not slide smoothly if left in the oven during a self-clean operation. If this occurs, wipe the rack and embossed rack supports with a small amount of vegetable oil to restore ease of movement, then wipe off excess oil.</p>

PARTS	CLEANING AGENTS	CLEANING PROCEDURES
Plastic finishes <ul style="list-style-type: none"> • Door handles • Backguard trim • Knobs • End caps 	<ul style="list-style-type: none"> • Soap and water • Non-abrasive plastic pad or sponge • Glass cleaner 	<p>NOTE: To prevent staining or discoloration, wipe up fat, grease or acid (tomato, lemon, vinegar, milk, fruit juice, marinade) immediately with a dry paper towel or cloth.</p> <ol style="list-style-type: none"> 1. When cool, clean with soap and water, rinse, and dry. 2. Use a glass cleaner and a soft cloth. <p>NOTE: Never use oven cleaners, abrasive or caustic liquid or powdered cleansers on plastic finishes. These cleaning agents will scratch or mar finish.</p>
Porcelain enamel <ul style="list-style-type: none"> • Cooktop • Backguard 	<ul style="list-style-type: none"> • Soap and water • Paste of baking soda and water • Non-abrasive plastic pad or sponge 	<p>Porcelain enamel is glass fused on metal and may crack or chip with misuse. It is acid resistant, not acid proof. All spillovers, especially acid or sugar spillovers, should be wiped up immediately with a dry cloth. This is especially important around the vent opening for smoothtop cooktop. Surface may discolor or dull if soil is not removed.</p> <ol style="list-style-type: none"> 1. When cool, wash with soapy water, rinse and dry. 2. Never wipe off a warm or hot surface with a damp cloth. This may cause cracking and chipping. 3. Never use oven cleaners, abrasive or caustic cleaning agents on exterior finish of range.
Surface burners <ul style="list-style-type: none"> • Conventional • Sealed 	<ul style="list-style-type: none"> • Soap and water • Paste of baking soda and water • Plastic scouring sponge or pad • Mildly abrasive cleanser 	<p>All burners: For ease of cleaning, clean burners each time the cooktop is used with warm soapy water. If a boilover occurs, remove pan to another burner; cool burner and clean. To remove stubborn soil, use a dry cloth and mildly abrasive cleanser. Use care to prevent cleaner from clogging ports. Burner must be dry before use. NOTE: Yellow tipping or distortion of the flame may occur until the burner is completely dry.</p> <p>Clean burner ports with a straight pin or small metal paper clip. Do not enlarge or distort ports. Do not use a wooden toothpick as it may break off and clog port. If ports are clogged or soiled, the burner may not light properly or the flame may not be even.</p> <p>Conventional burners: Dry burners in the oven set at 170°F.</p> <p>Sealed burners: Sealed burner can not be removed by the consumer. When cleaning burner, use care to prevent damage to the ignitor. Surface burner will not light properly if ignitor is damaged, broken, soiled, or wet. When cleaning the ports, be sure to clean the port directly below the ignitor.</p>

ABOUT CLEANING PRODUCTS

READ THE MANUFACTURER'S INSTRUCTIONS to be sure the cleaner can be safely used on this appliance. Carefully follow manufacturer's directions.

Test a small inconspicuous area using a very light pressure to see if the surface may scratch or discolor. This is particularly important for porcelain enamel, highly polished or shiny metal or plastic surfaces, and painted surfaces.

Glass Cleaners – Bon Ami, Cinch, Glass Plus, Windex.

Dishwashing Liquid Detergents – Dawn, Dove, Ivory, Joy.

Mild Liquid Spray Cleaners – Fantastik, Formula 409.

Non-Abrasive Cleaners – Bon Ami, paste of baking soda and water.

Mildly Abrasive Powder or Liquid All Purpose Cleansers – Ajax, Barkeepers Friend, Cameo, Comet, Soft Scrub.

Non-Abrasive or Scratchless Plastic or Nylon Scouring Pads or Sponges – Chore Boy Plastic Cleaning Puff, Scrunge Scrub Sponges, or Scotch-Brite No Scratch, Cookware or Kitchen Sponge.

Abrasive Scouring Pads – S.O.S., Brillo Steel Wool Soap, Scotch-Brite Pads.

(Brand names for the above cleaning products are registered trademarks of the respective manufacturers.)

COOKTOP – CONVENTIONAL BURNERS

The cooktop featuring conventional surface burners lifts up for easy cleaning of the burner box area.

To raise the “lift-up” cooktop: When cool, grasp the front edge of the cooktop and gently lift up until the two support rods at the front of the cooktop snap into place.

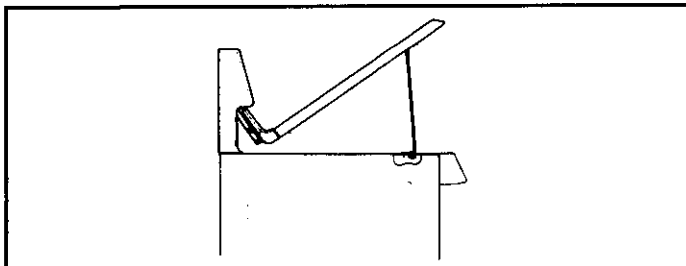

To lower the top: Hold the front edge of the cooktop and carefully push back on each support rod to release the notched support. Then gently lower the top into place. The support rods will slide into the cooktop frame.

COOKTOP – SEALED BURNERS

The sealed burner cooktop is designed with two contour wells to catch and contain spills. Because of this design it is not necessary to lift up the cooktop to clean underneath. To prevent damage to the gas tubing or top, do not attempt to lift or remove the cooktop.

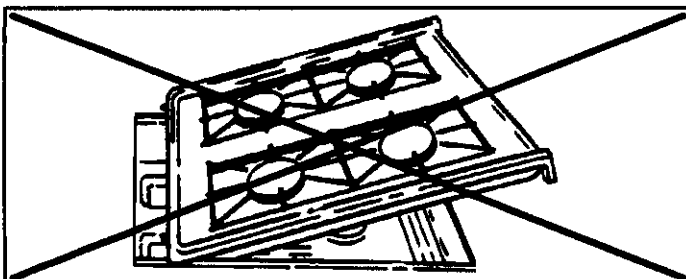

BURNER GRATES

Burner grates must be properly positioned before cooking. Burner grates are durable but may gradually lose their shine due to usage and high temperatures.

Grates for the porcelain cooktop are square. When installing square grates, place indented sides together so straight sides are at front and rear.

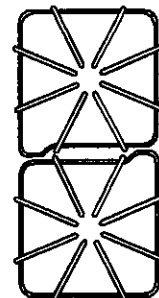

CAUTION: Do not operate a surface burner without a pan on the grate. The porcelain finish on the grate may chip without a pan to absorb the intense heat from the burner flame.

OVEN LIGHT

CAUTION: Before replacing the light bulb, **DISCONNECT POWER TO RANGE.** Be sure the bulb is cool. Do not touch a hot bulb with a damp cloth as the bulb may break.

To turn on oven light: Push the rocker switch located on the backguard.

To replace oven light bulb:

1. Disconnect power to range.
2. Hold bulb cover in place then slide wire retainer off cover. **NOTE:** Bulb cover will fall if not held in place while removing wire retainer.
3. Remove bulb cover.
4. Remove light bulb and replace with a 40 watt appliance bulb.
5. Replace bulb cover and secure with wire retainer.
6. Reconnect power to range. Reset clock.

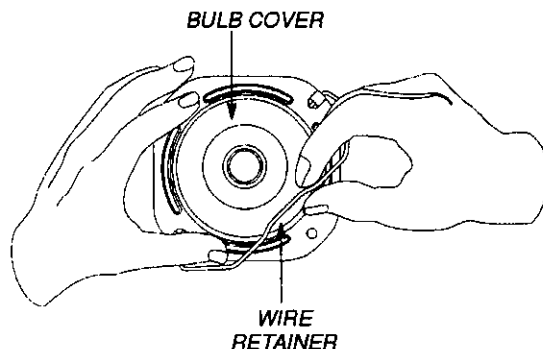

OVEN DOOR

Do not place excessive weight on an open oven door or stand on an open oven door as, in some cases, it could cause the range to tip over, break the door or cause serious injury to the user.

When opening the oven door, allow steam and hot air to escape before reaching in oven to check, add or remove food.

Do not attempt to open or close door until the door is completely seated on the hinge arms. Never turn on the oven unless door is properly in place. When baking, be sure the door is completely closed. Baking results will be affected if the door is not securely closed.

When the range is new the door may feel "spongy" when you close the door. This is normal and will become less "spongy" with use.

To remove lift-off door: Open the door to the "stop" position (opened about 6 inches) and grasp the door with both hands at each side. Do not use the door handle to lift the door. Lift up evenly until the door clears the hinge arms.

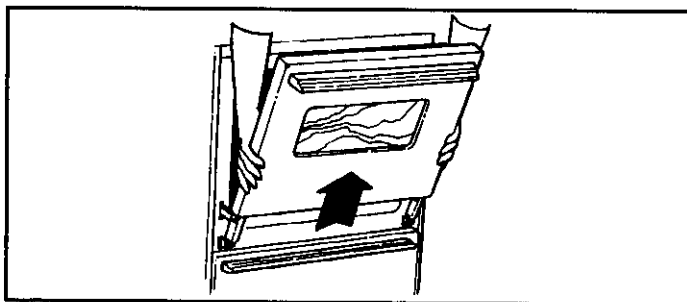

To replace door: Grasp the door at each side, align slots in the door with the hinge arms and slide the door down onto the hinge arms until door is seated on hinges. Push down on top corners of door to completely seat door on hinges. The door is not completely seated on the hinges if one side is higher or if the door appears to be crooked.

CAUTION: Hinge arms are spring mounted and will slam shut against the range if accidentally hit. **Never place hand or fingers between the hinges and the front oven frame.** You could be injured if hinge snaps back.

DOOR LOCK LEVER

The oven door is locked for a self-clean operation only. Do not move the door lock lever to the right or locked position during a cooking operation. If the door is locked, the operation will automatically be cancelled and "door" will appear in the display. If the oven is hot enough to engage the internal lock, the oven door will not open. Allow the oven to cool for up to an hour, then unlock and open the door.

OVEN BOTTOM

Protect oven bottom against excessive spillovers especially acid or sugary spillovers as they may discolor the porcelain.

To protect oven bottom:

- Use the correct size cooking utensil to avoid boilovers.
- Never place cookware or aluminum foil directly on the oven bottom.
- *To prevent boilovers from searing the oven bottom*
Place a piece of aluminum foil that is slightly larger than the pan on the oven rack directly below the pan.

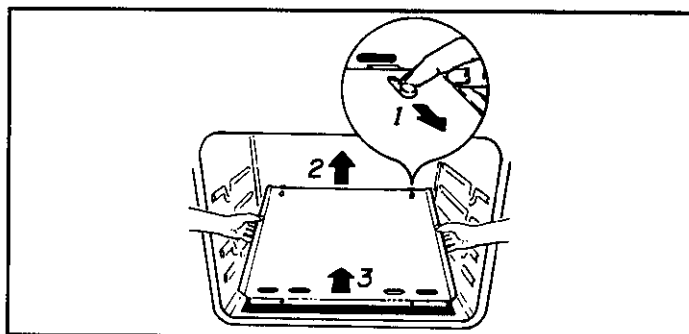

To remove: When cool, remove the oven racks. Slide the two catches, located at each rear corner of the oven bottom, toward the front of the oven.

Lift the rear edge of the oven bottom slightly, then slide it back until the front edge of the oven bottom clears the oven front frame. Remove oven bottom from oven.

To replace: Fit the front edge of the oven bottom into the oven front frame. Lower the rear of the oven bottom and slide the two catches back to lock the oven bottom into place.

MAINTENANCE

OVEN RACKS

The two oven racks are designed with a safety lock-stop position to keep the racks from accidentally coming completely out of the oven when pulling the rack out to add or remove food.

CAUTION: Do not attempt to change the rack positions when the oven is hot.

To remove: Be sure the rack is cool. Pull the rack straight out until it stops at the lock-stop position. Tilt the front end of the rack up and continue pulling the rack out of the oven.

To replace: Place the rack on the rack supports and tilt the front end of the rack up slightly. Slide it back until it clears the lock-stop position. Lower the front and slide the rack straight in. Pull the rack out to the lock-stop position to be sure it is positioned correctly and then return it to its normal position.

It is important that air can circulate freely within the oven and around the food. To help ensure this, place food on the center of the oven rack. Allow two inches between the edge of the utensil(s) and the oven walls.

For optimum baking results of cakes, cookies or biscuits use one rack. Position the rack so the food is in the center of the oven. Use either rack position 3 or 2.

If cooking on more than one rack, stagger the food to ensure proper air flow.

If cooking on two racks, use rack positions 4 and 2 for cakes and rack positions 4 and 1 when using cookie sheets. Never place two cookie sheets on one rack.

If roasting a large turkey, place the turkey on rack 1 or the roasting position and the side dishes on rack 5.

RACK POSITIONS

RACK 5 (highest position)	Used for toasting bread, or for two-rack baking.
RACK 4	Used for most broiling and two-rack baking.
RACK 3	Used for most baked goods on a cookie sheet or jelly roll pan, or frozen convenience foods.
RACK 2	Used for roasting small cuts of meat, large casseroles, baking loaves of bread, cakes (in either tube, bundt, or layer pans) or two-rack baking.
RACK 1	Used for roasting large cuts of meat and large poultry, pies, souffles, or angel food cake, or for two-rack baking.
ROASTING POSITION	Used for roasting taller cuts of meat or turkey. Place both oven racks, one above the other, on the raised sides of the oven bottom.

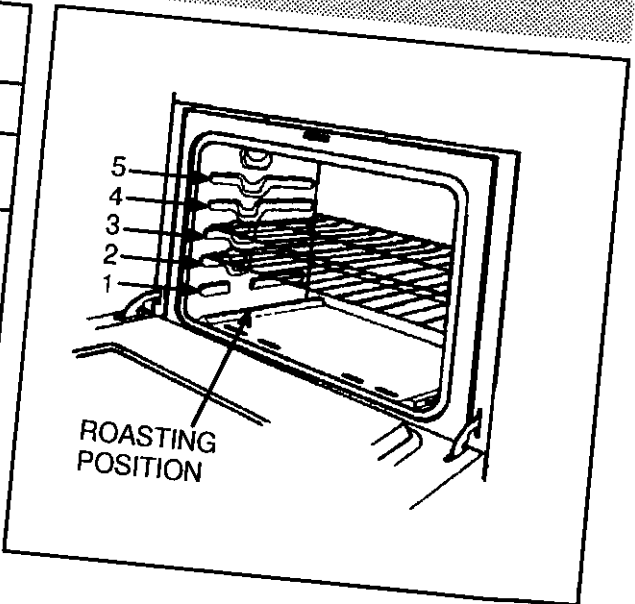

STORAGE DRAWER

The storage drawer at the bottom of the range is safe and convenient for storing metal and glass cookware. DO NOT store plastic, paperware, food or flammable material in this drawer. Remove drawer to clean under range.

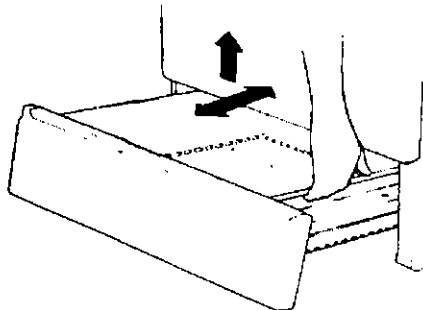

To remove: Pull drawer out to the first stop position. Lift up front of drawer and pull to the second stop position. Grasp sides and lift up and out.

To replace: Fit the rollers located at the ends of the drawer glides into the rails on the range. Lift up drawer front and gently push in to first stop position. Lift up drawer again and continue to slide drawer to the closed position.

LEVELING LEGS

Some floors are not level. For proper baking, your range must be level. Leveling legs are located on each corner at the base of the range. Level by turning the legs. To prevent range from accidentally tipping, range should be secured to the floor by sliding a rear leveling leg into the anti-tip bracket supplied with the range.

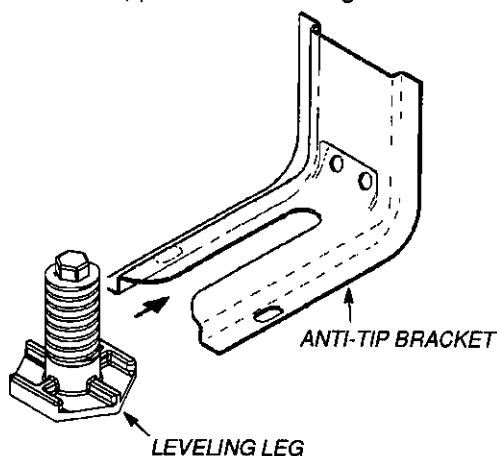
**HOW TO REMOVE RANGE FOR CLEANING AND SERVICING**

Follow these procedures to remove appliance for cleaning or servicing:

1. Shut-off gas supply to appliance.
2. Disconnect electrical supply to appliance, if equipped.
3. Disconnect gas supply tubing to appliance.
4. Slide range forward to disengage range from the anti-tip bracket. (See Installation Instructions for location of bracket.)
5. Reverse procedure to reinstall. If gas line has been disconnected, check for gas leaks after reconnection. A qualified servicer should disconnect and reconnect the gas supply. (See Installation Instructions for gas leak test method.)

NOTE: A qualified servicer should disconnect and reconnect the gas supply.

To prevent range from accidentally tipping, range must be secured to the floor by sliding rear leveling leg into an anti-tip bracket supplied with the range.

WARNING: Possible risks may result from abnormal usage, including excessive loading of the oven door and of the risk of tip over, should the appliance not be reinstalled according to the installation instructions.

ELECTRICAL CONNECTION

Appliances which require electrical power are equipped with a three-prong grounding plug which must be plugged directly into a properly grounded three-hole 120 volt electrical outlet.

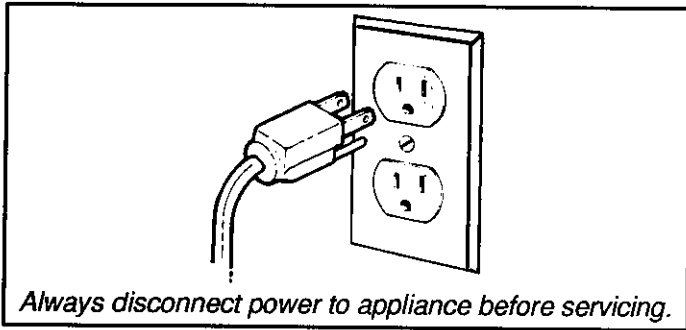

The three-prong grounding plug offers protection against shock hazards. **DO NOT CUT OR REMOVE THE THIRD GROUNDING PRONG FROM THE POWER CORD PLUG.**

If an ungrounded, two-hole or other type electrical outlet is encountered, it is the personal responsibility of the appliance owner to have the outlet replaced with a properly grounded three-hole electrical outlet.

PROPORTIONAL VALVE ADJUSTMENT

The LOW setting should produce a stable flame when turning the knob from HI to LO. The flame should be 1/8 inch or lower and must be stable on all ports on LOW setting.

To adjust: Operate burner on HI for about 5 minutes to preheat burner cap. Turn knob back to LO; remove knob, and insert a small screwdriver into the center of the valve stem. Adjust flame size by turning adjustment screw in either direction.

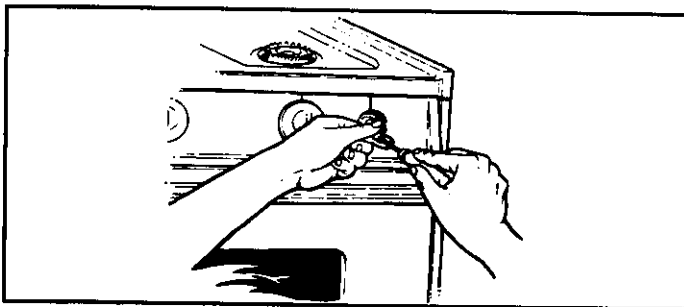

Flame must be of sufficient size to be stable on all burner ports. If flame adjustment is needed, adjust **ONLY** on the LO setting. Never adjust flame size on a higher setting.

NOTE: All gas adjustments should be done by a qualified servicer only.

OVEN TEMPERATURE ADJUSTMENT

You can adjust the oven temperature if you feel the temperature is too hot or too cool.

To adjust the oven temperature:

1. Press BAKE pad.
2. Press ▲ pad until 550° is displayed.
3. Press and hold BAKE pad until 0° appears in display.
4. Press and hold the ▲ or ▼ pad to select the temperature change you wish.

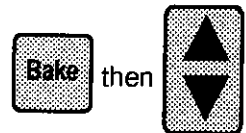
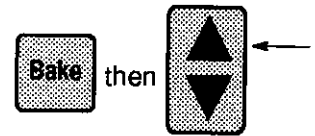

- The oven temperature can be increased or decreased by 5° to 35°.
- If the oven temperature was previously adjusted, the change will be displayed.

For example: If the oven temperature was reduced by 15°, the display will show - 15°.

It is not necessary to readjust the oven temperature if there is a power failure or interruption. Broiling and cleaning temperatures cannot be adjusted.

EXPLANATION OF FAULT CODES

If a fault code appears in the display and continuous beeps sound, press the CANCEL pad. Then, reprogram the cooking operation. If the fault code reappears in the display, call an authorized servicer. Do not use the oven until the appliance has been serviced.

NOTE: If the oven is heavily soiled, excessive smoke and flaring may result in a fault code during a self-clean cycle. If this occurs, press the CANCEL pad and allow the oven to cool for an hour.

TROUBLESHOOTING CHART

PROBLEM	POSSIBLE CAUSES	SUGGESTED CORRECTIONS
Surface burner fails to light	<ul style="list-style-type: none"> a. power supply not connected b. air in the gas line c. clogged burner port(s) d. surface control not completely turned to the LITE position or turned too quickly from the LITE position e. power failure f. sealed burner models: Burner will not light if the ignitor is damaged, soiled, wet or if the port directly below the ignitor is blocked. 	<ul style="list-style-type: none"> a. connect power, check circuit breaker or fuse box b. see page 7 for instructions on bleeding air from the gas line c. clean ports with straight pin d. turn control to the LITE position until the burner ignites, then turn control to desired flame size e. see page 7 to light burner during a power failure f. clean and dry burner head. If broken or damaged, call a serviceman.
Burner flame uneven	<ul style="list-style-type: none"> a. clogged burner port(s) 	<ul style="list-style-type: none"> a. clean ports with straight pin
Surface burner flame <ul style="list-style-type: none"> • lifts off port • yellow in color 	<ul style="list-style-type: none"> a. air/gas mixture not proper b. no pan in place <p>NOTE: Lifting of flame is normal for sealed burners. Some yellow tipping with LP gas is normal and acceptable.</p>	<ul style="list-style-type: none"> a. call serviceman to adjust burner b. always place pan on grate before lighting burner. <p>NOTE: Be sure installer properly adjusted range at time of installation.</p>
Surface burner ignitor producing clicking sound	<ul style="list-style-type: none"> a. control knob is in the LITE position. NOTE: The life of the ignition system may be shortened if the knob is left in the LITE position. b. surface control switch is moist as a result of cleaning the range. c. malfunctioning switch 	<ul style="list-style-type: none"> a. be sure ALL surface burner control knobs are in the OFF position or are adjusted to the desired flame setting b. allow switch to dry then relight burner c. call serviceman to check
Oven burner fails to light	<ul style="list-style-type: none"> a. power supply not connected b. power failure c. oven incorrectly set d. Automatic Oven Cooking feature incorrectly set 	<ul style="list-style-type: none"> a. connect power, check circuit breaker or fuse box b. oven will not operate during a power failure c. See pages 5 or 12 d. See page 16
Popping sound heard when burner extinguishes	This is a normal sound that occurs with some types of gas when a hot burner is turned off. The popping sound is not a safety hazard and will not damage the appliance.	
Clock and/or oven light does not work	<ul style="list-style-type: none"> a. power supply not connected b. bulb may be loose or burned out c. malfunctioning switch, starter or ballast d. malfunctioning clock or loose wiring 	<ul style="list-style-type: none"> a. connect power supply, check circuit breaker or fuse box b. tighten or replace light bulb c. call serviceman to check d. call serviceman to check

TROUBLESHOOTING CHART

PROBLEM	POSSIBLE CAUSES	SUGGESTED CORRECTIONS
Moisture condensation on oven window	a. it is normal for the window to fog during the first few minutes the oven is on b. cloth saturated with water is used to clean the window	a. leave door ajar for one or two minutes to allow moisture to escape b. Use a damp cloth to clean window to prevent excess water from seeping between the panels of glass
Baking results not satisfactory <ul style="list-style-type: none"> • food takes too long or cooks too fast • pale browning • food over-done on outside and under-done in center • over browning 	a. oven not preheated b. incorrect rack position c. incorrect use of aluminum foil d. oven bottom incorrectly replaced e. door incorrectly replaced	a. preheat oven 8 to 15 minutes b. see page 26 c. see page 13 d. replace oven bottom correctly e. see page 25 See Problem Chart on page 14 See baking tips on page 13
Oven smokes excessively during a broil operation	a. food too close to burner b. meat has too much fat c. sauce applied too early or marinade not completely drained d. soiled broiler pan e. broiler insert covered with aluminum foil	a. move broiler pan down one rack position b. trim fat c. apply sauce during last few minutes of cooking. If meat has been marinated, drain thoroughly before cooking d. always clean broiler pan and insert after each use e. never cover insert with foil as this prevents fat from draining to pan below
"F" plus a number appears in display. <div style="background-color: black; color: white; padding: 5px; display: inline-block; margin-top: 5px;">F9</div>	This is called a FAULT CODE . If a fault code appears in the display and beeps sound, press CANCEL pad. If the fault code and beeps continue, disconnect power to the appliance and call an authorized servicer. If the oven is heavily soiled, excessive flare-ups may result in a fault code during a clean cycle. Press CANCEL pad and allow oven to cool for one hour then reset the clean cycle.	

COOKING APPLIANCE WARRANTY

FULL WARRANTY – Parts and Labor

For **one (1) year** from the date of original purchase date, any part which fails in normal home use will be repaired or replaced free of charge.

LIMITED WARRANTY – Parts only

For an additional **four (4) years** beyond the first year of the full warranty period – Parts listed below will be repaired or replaced free of charge for the part itself, with the owner paying all other costs, including labor, mileage, and transportation.

Gas sealed surface burner which fails in normal home use

Canadian Residents: The above warranties only cover an appliance installed in Canada that has been certified or listed by appropriate test agencies for compliance to a National Standard of Canada unless the appliance was brought into Canada due to transfer of residence from the United States to Canada.

The specific warranties expressed above are the **only** warranties provided by the manufacturer. These warranties give you specific legal rights, and you may also have other rights which vary from state to state.

WHAT IS NOT COVERED BY THESE WARRANTIES:

1. Conditions and damages resulting from any of the following:
 - a. Improper installation, delivery, or maintenance.
 - b. Any repair, modification, alteration or adjustment not authorized by the manufacturer or an authorized servicer.
 - c. Misuse, abuse, accidents or unreasonable use.
 - d. Incorrect electrical current, voltage or supply.
 - e. Improper setting of any control.
2. Warranties are void if the original serial numbers have been removed, altered, or cannot be readily determined.
3. Light bulbs.
4. Products purchased for commercial or industrial use.
5. The cost of service or service call to:
 - a. Correct installation errors.
 - b. Instruct the user on the proper use of the product.
 - c. Transport the appliance to a servicer.
6. Consequential or incidental damages sustained by any person as a result of any breach of these warranties.

Some states do not allow the exclusion or limitation of consequential or incidental damages, so the above exclusion may not apply to you.

HOW TO RECEIVE WARRANTY SERVICE:

1. For authorized service, contact the dealer from whom you purchased the appliance, or call Maytag Appliances Sales Company at: **1-800-688-1120**.
2. If you are not able to satisfactorily resolve the complaint with local response, call or write to:

Maytag Appliances Sales Company
Attn. CAIR Center
P.O. Box 2370
Cleveland, TN 37320-2370
1-800-688-1120
3. When requesting service, the following information will be needed:
 - a. Your name, address and telephone number.
 - b. Model and serial numbers (found on the data plate).
 - c. Name and address of dealer or servicer.
 - d. Proof of purchase date (sales receipt).
 - e. A clear description of the problem and service history.