

Use

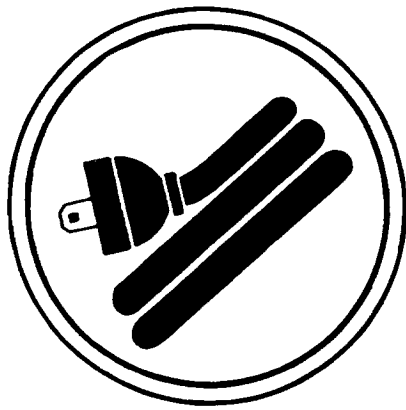

And

Care

Instructions for your Electric Range

CONTENTS

SAFETY INSTRUCTIONS	1-3	Oven racks	8
FEATURES	4-5	Preheating	8
Digital clock/timer	4	How to bake or roast	9
Continuous cleaning oven	5	Common baking problem chart	9
USING YOUR COOKTOP	6-7	How to broil	10
Surface elements	6	MAINTENANCE	11
Drip bowls	6	Oven light	11
Control knobs	6	Storage drawer	11
Signal lights	6	Oven door	11
Cooking tips	6	Leveling legs	11
Cookware	6	Fuses (Canada only)	11
Heat settings	7	CARE AND CLEANING CHART	12
USING YOUR OVEN	8-10	SERVICE	13
Oven characteristics	8	Troubleshooting	13
Oven controls	8	WARRANTY	14
Oven indicator light	8		

INSTALLER Please leave this manual with this appliance.

CONSUMER To save you time, energy and money, read and keep this manual for future reference.

The model and serial numbers of your appliance are found on the rating plate which is located behind the storage drawer on the front frame.

Model number: _____

Serial number: _____

Date of purchase: _____

SAFETY INSTRUCTIONS

Information in the Safety Instruction section covers all electric cooking appliances. You may find some information that does not pertain to your particular appliance. Please review this section before using your cooking appliance.

The following instructions are based on safety considerations and must be strictly followed to eliminate the potential risks of fire, electric shock, or personal injury.

PROPER INSTALLATION – Be sure your appliance is properly installed and grounded by a qualified technician.

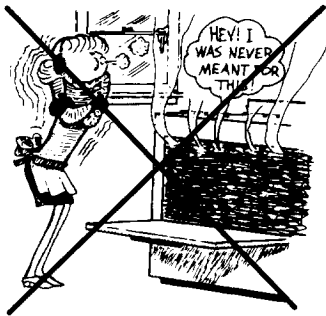

NEVER USE YOUR APPLIANCE FOR WARMING OR HEATING THE ROOM.

STORAGE ABOVE RANGE – To eliminate the hazard of reaching over hot surface elements, cabinet storage should not be provided directly above a unit. If provided, storage should be limited to infrequently used items that can be safely stored in an area subjected to heat. Temperatures may be unsafe for some items such as volatile liquids, cleaners, or aerosol sprays. If cabinet storage is provided, installation of a range hood that projects at least 5-inches beyond the bottom of the cabinet will reduce the hazards associated with such storage.

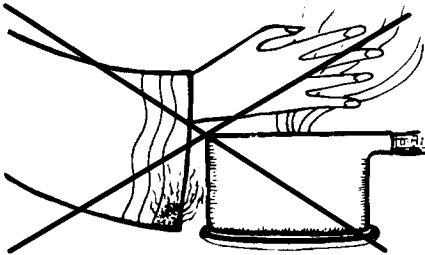

WEAR PROPER APPAREL – Loose-fitting or hanging garments should never be worn while using the appliance.

USER SERVICING – Do not repair or replace any part of the appliance unless specifically recommended in the Use and Care Book. All other servicing should be referred to a qualified technician. Always disconnect unit or cut-off power to unit before any servicing.

STORAGE IN, ON OR NEAR APPLIANCE – Do not store or use gasoline or other flammable materials, vapors and liquids in the oven, near surface units or in the vicinity of this or any other appliance. The fumes can create a fire hazard or explosion. Do not use cooktop or oven as a storage area for food or cooking utensils.

DO NOT USE WATER ON GREASE FIRES

– Smother fire or flame or use dry chemical or foam-type extinguisher, if available or sprinkle heavily with baking soda.

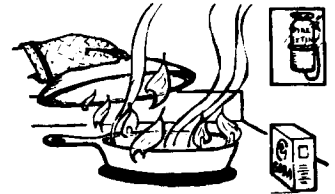

USE ONLY DRY POTHOLDERS – Moist or damp potholders on hot surfaces may result in burns from steam. Do not let potholder touch hot heating elements. Do not use a towel or other bulky cloths.

SURFACE COOKING UNITS:

USE PROPER PAN SIZE – This appliance is equipped with one or more surface elements of different sizes. Select utensils having flat bottoms large enough to cover the surface element. The use of undersized utensils will expose a portion of the heating element to direct contact and may result in ignition of clothing. Proper relationship of utensil to element will also improve efficiency.

NEVER LEAVE SURFACE UNITS UNATTENDED AT HIGH HEAT SETTINGS – Boilover causes smoking and greasy spillovers that may ignite.

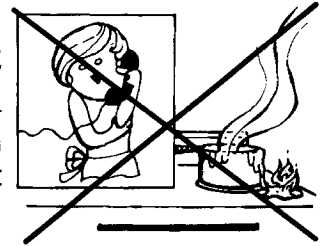

MAKE SURE DRIP BOWLS ARE IN PLACE – Absence of these bowls during cooking may subject wiring or components underneath to damage.

PROTECTIVE LINERS – Do not use aluminum foil to line surface unit drip bowls or oven bottoms, except as suggested in the Use and Care Book. Improper installation of these liners may result in a risk of electric shock, or fire.

SAFETY INSTRUCTIONS

GLAZED COOKING UTENSILS – Only certain types of glass, glass/ceramic, ceramic, earthenware, or other glazed utensils are suitable for range-top service without breaking due to the sudden change in temperature.



UTENSIL HANDLES SHOULD BE TURNED INWARD AND NOT EXTEND OVER ADJACENT SURFACE UNITS – To reduce the risk of burns, ignition of flammable materials, and spillage due to unin-

tentional contact with the utensil, the handle of a utensil should be positioned so that it is turned inward, and does not extend over adjacent surface elements.

DO NOT SOAK REMOVABLE HEATING ELEMENTS – Heating elements should never be immersed in water. Immersing element in water would damage insulating material inside element.

OVENS:

USE CARE WHEN OPENING DOOR – Let hot air or steam escape before removing or replacing food.

DO NOT HEAT UNOPENED FOOD CONTAINERS – Build-up of pressure may cause container to burst and result in injury.

KEEP OVEN VENT DUCTS (located under rear element; rear corner of cooktop; between oven door and control panel of wall oven or on backguard) **UNOBSTRUCTED**. Blockage of vent prevents proper oven air circulation and will affect oven performance. Avoid touching oven vent area while oven is on and for several minutes after oven is turned off. Some parts of the vent and surrounding area become hot enough to cause burns.

PLACEMENT OF OVEN RACKS – Always place oven racks in desired location while oven is cool. If rack must be moved while hot, use care to avoid contact of potholder with oven element.

VENTILATING HOODS:

CLEAN VENTILATING HOODS FREQUENTLY – Grease should not be allowed to accumulate on hood or filter. When flaming foods under the hood, turn the fan off. The fan, if operating, may spread the flame.

IMPORTANT SAFETY NOTICE AND WARNING

The California Safe Drinking Water and Toxic Enforcement Act of 1986 (Proposition 65) requires the Governor of California to publish a list of substances known to the State of California to cause cancer or reproductive harm, and requires businesses to warn customers of potential exposures to such substances.

Users of this appliance are hereby warned that when the appliance is engaged in the self-clean cycle there may be some low-level exposure to some of the listed substances, including carbon monoxide. Exposure to these substances can be minimized by properly venting the appliance to the outdoors during the self-clean cycle.

DEEP FAT FRYERS:

Use extreme caution when moving the grease kettle or disposing of hot grease.

DO NOT TOUCH SURFACE ELEMENTS OR OVEN ELEMENTS, AREAS NEAR ELEMENTS OR INTERIOR SURFACES OF OVEN

– Elements may be hot even though they are dark in color. Areas near surface elements and interior surfaces of oven may become hot enough to cause burns. During and after use, do not touch or let clothing or other flammable materials contact heating elements, areas near elements or interior surfaces of oven until they have had sufficient time to cool. Among these areas are the cooktop, surfaces facing the cooktop, oven vent opening and surfaces near this opening, oven door, and oven window. Also, do not allow aluminum foil, meat probes or any other metal object, other than a utensil on a surface element, to contact heating elements.

ANTI-TIP BRACKET:

WARNING: To reduce the risk of tipping of the appliance from unusual usage or by excessive loading of the oven door, the appliance must be secured by a properly installed anti-tip device. To check if device is installed properly: Use a flashlight and look underneath range to see that one of the rear leveling legs is engaged in the bracket slot. When removing appliance for cleaning, be sure anti-tip device is engaged when range is replaced. The anti-tip device secures the rear leveling leg to the floor, when properly engaged.

SAFETY INSTRUCTIONS

ADDITIONAL INFORMATION:

After appliance is installed, be certain all packing materials are removed from the appliance before operating the unit. If appliance is installed near a window, take steps to prevent curtains from blowing over surface elements creating a fire hazard.

Care should be given to location of appliance. Be sure floor covering under appliance, walls adjacent to appliance, cabinetry adjacent to appliance, and other materials adjacent to appliance can withstand prolonged heat. This is a heavy appliance and can settle into soft floor coverings such as cushioned vinyl. Use care when moving range on this type of floor covering.

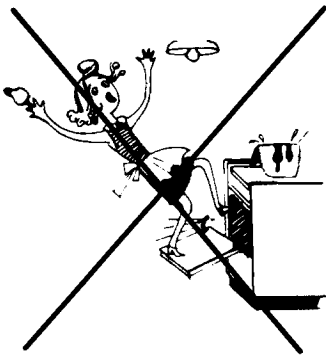

OVEN DOOR

Do not place excessive weight on an open oven door or stand on an open oven door as, in some cases, it could cause the range to tip over, breakage of the door or serious injury.

CIRCUIT BREAKER OR FUSE – Locate and mark breaker or fuse. Never replace a blown fuse or reset a breaker until you know what has caused the problem. Always replace a blown fuse with one of the correct amperage, do not use a substitute.

CONTROL KNOBS – Turn off control at the completion of a cooking operation.

SELF CLEANING OVEN:

Do not clean door gasket. The door gasket is essential for a good seal. Care should be taken not to rub, damage, or move the gasket. Do not use oven cleaners or oven liner protective coating of any kind in or around any part of the self clean oven. Clean only parts listed in this booklet. Before self cleaning the oven, remove broiler pan, oven racks, and other utensils.

CAUTION: DO NOT LEAVE FOOD OR COOKING UTENSILS, ETC., IN OVEN DURING THE SELF CLEANING MODE OF OPERATION.

ATTENTION: NE LAISSER AUCUN ALIMENT, USTENSILE DE CUISINE, ETC., DANS LE FOUR DURANT LE CYCLE D'AUTONETTOYAGE.

On some models, a fan should be heard during the self clean cycle. If not, cancel clean cycle and call a serviceman before self cleaning again. (Refer to CONTENTS on front cover for location of self clean instructions and fan information.)

SMOOTHTOP COOKTOP:

Do not cook on broken cooktop. If cooktop should break, cleaning solutions and spillovers may penetrate the broken cooktop and create a risk of electric shock. Contact a qualified technician immediately. Clean cooktop with caution. If a wet sponge or cloth is used to wipe spills on a hot cooking area, be careful to avoid steam burn. Some cleaners can produce noxious fumes if applied to a hot surface.

DO NOT LEAVE CHILDREN ALONE – Children should not be left alone or unattended in area where appliance is in use. They should never be allowed to sit or stand on any part of the appliance. **CAUTION:** Do not store items of interest to children in cabinets above an appliance or on the backguard of a range.

Children climbing on the appliance to reach items could be seriously injured. Children must be taught that the appliance and utensils in or on it can be hot. Children should be taught that an appliance is not a toy. They should not be allowed to play with controls or other parts of the unit.

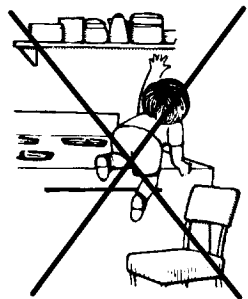

IN CASE OF FIRE:

1. Turn off appliance and ventilating hood.
2. Use dry or foam-type extinguisher or baking soda to smother flame. Never use water on a grease fire.
3. If fire is in oven, smother by closing oven door.
4. If fire is in a pan on the surface unit, cover pan.

– SAVE THESE INSTRUCTIONS –

FEATURES

DIGITAL CLOCK AND TIMER

If your range is equipped with a digital clock and timer, it will either be design 1 or design 2. Follow the instructions for the illustration that matches the clock on your range.

DESIGN 1

When range is first connected to power or if power is interrupted, 12:00 will flash in the display.

TO SET CLOCK: Slide switch up to CLOCK position.

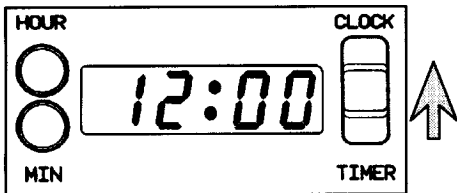

Press and hold HOUR button until correct hour appears in the display.

Press and hold MIN button until the correct minutes appear in the display.

TO SET MINUTE TIMER: Slide switch down to TIMER position. The timer will automatically begin counting down from 1 hour in increments of one minute.

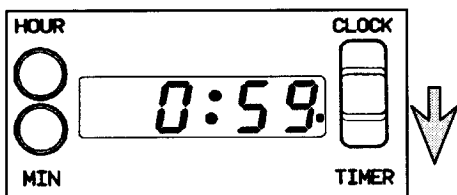

(0:59) will be displayed as soon as the switch is moved to the TIMER position.)

The timing operation will be cancelled if the switch is moved to the CLOCK position.

TO SET A TIMING OPERATION FOR LESS THAN ONE HOUR: Press and hold MIN button until desired time appears in the display. Timer will immediately begin counting down as soon as the MIN button is released.

TO SET A TIMING OPERATION FOR ONE TO TWO HOURS: Press the HOUR button. (1:59 will appear in the display.) Select desired minutes by pressing and holding MIN button. Timing will begin when button is released. Two hours is the maximum timing that can be set.

TO CANCEL MINUTE TIMER OPERATION OR STOP "END-OF-TIME" BEEPS: Slide switch up to the clock position. Time-of-day will reappear in the display.

DESIGN 2



88:88 will flash in the display when range is first connected to power or if power is interrupted.

TO SET CLOCK: Press and hold CLOCK SET button while turning MINUTE TIMER knob to the correct time-of-day. MINUTE TIMER knob can be turned in either direction.

TO SET MINUTE TIMER: Turn MINUTE TIMER knob to the right, to the desired time, up to 60:00 (1 hour). Timer will begin counting down after a few seconds delay. When time has lapsed, a continual beep will sound for up to 2 minutes.

Press CLOCK SET button to stop beep sounds. The correct time-of-day will reappear in the display.

TO CANCEL A TIMING OPERATION: Turn MINUTE TIMER knob to the left, until 00:00 appears in the display. The correct time-of-day will reappear in the display after a few seconds delay.

To check time-of-day during a timing operation, press and hold CLOCK SET button. Time will reappear in the display.

FEATURES

DIGITAL CLOCK AND TIMER

If your range is equipped with a digital clock and timer, it will either be design 1 or design 2. Follow the instructions for the illustration that matches the clock on your range.

DESIGN 1

When range is first connected to power or if power is interrupted, 12:00 will flash in the display.

TO SET CLOCK: Slide switch up to CLOCK position.

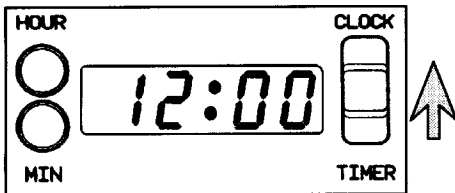

Press and hold HOUR button until correct hour appears in the display.

Press and hold MIN button until the correct minutes appear in the display.

TO SET MINUTE TIMER: Slide switch down to TIMER position. The timer will automatically begin counting down from 1 hour in increments of one minute.

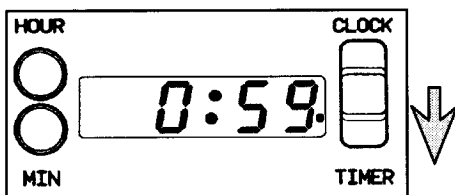

(0:59) will be displayed as soon as the switch is moved to the TIMER position.)

The timing operation will be cancelled if the switch is moved to the CLOCK position.

TO SET A TIMING OPERATION FOR LESS THAN ONE HOUR: Press and hold MIN button until desired time appears in the display. Timer will immediately begin counting down as soon as the MIN button is released.

TO SET A TIMING OPERATION FOR ONE TO TWO HOURS: Press the HOUR button. (1:59 will appear in the display.) Select desired minutes by pressing and holding MIN button. Timing will begin when button is released. Two hours is the maximum timing that can be set.

TO CANCEL MINUTE TIMER OPERATION OR STOP "END-OF-TIME" BEEPS: Slide switch up to the clock position. Time-of-day will reappear in the display.

DESIGN 2



88:88 will flash in the display when range is first connected to power or if power is interrupted.

TO SET CLOCK: Press and hold CLOCK SET button while turning MINUTE TIMER knob to the correct time-of-day. MINUTE TIMER knob can be turned in either direction.

TO SET MINUTE TIMER: Turn MINUTE TIMER knob to the right, to the desired time, up to 60:00 (1 hour). Timer will begin counting down after a few seconds delay. When time has lapsed, a continual beep will sound for up to 2 minutes.

Press CLOCK SET button to stop beep sounds. The correct time-of-day will reappear in the display.

TO CANCEL A TIMING OPERATION: Turn MINUTE TIMER knob to the left, until 00:00 appears in the display. The correct time-of-day will reappear in the display after a few seconds delay.

To check time-of-day during a timing operation, press and hold CLOCK SET button. Time will reappear in the display.

USING YOUR COOKTOP

SURFACE ELEMENTS

See separate booklet if your range features the solid disc elements.

Surface elements are self cleaning. Do not immerse elements in water. When an element is turned on, it will cycle on and off to maintain the heat setting.

To remove: Raise element WHEN COOL and carefully pull out and away from the receptacle.

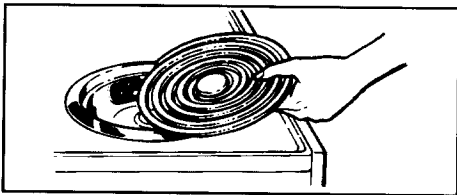

To replace: Insert the terminals on the element into the receptacle. Gently lift up on outer edge of element (opposite terminal—side of element) while inserting terminals into receptacle. Gently press down on outer edge of element until element sits level on drip bowl.

Be sure drip bowl and chrome trim ring are properly installed. Notch on trim ring should be centered over the screw securing the receptacle to the maintop. If trim ring is not installed properly and rests on this screw, the trim ring and drip bowl will "rock".

DRIP BOWLS

The drip bowls, located under each surface element, are designed to catch spills or boilovers.

Be sure drip bowls are in place. Absence of these bowls during cooking may subject wiring or component parts underneath the cooktop to damage.

Clean after each use with soap and water. Remove stubborn stains with baking soda paste and plastic scouring pad. To prevent scratching the finish, do not use abrasive cleaning agents. Rinse, dry and replace.

To prevent risk of electric shock or fire, do not line drip bowls with aluminum foil.

Drip bowls will turn blue or gold over time or if overheated. This type of discoloration is permanent and will not affect cooking performance. To protect finish, avoid using high settings for long periods of time. Reduce to a lower setting once food begins cooking. Also, do not use oversized utensils. Utensil should not extend more than 2 inches from the element.

CONTROL KNOBS

Your cooktop is equipped with control knobs that provide an infinite choice of settings from LOW to HIGH. The knob can be set on any of the numbered settings or between the numbered settings. To operate push in and turn knob to the desired setting.

SIGNAL LIGHTS

Ranges are equipped with one to four signal lights to indicate when a surface element is on. The light will remain on until the element is turned off. After a cooking operation, be sure element and signal light are off.

TIPS FOR SUCCESSFUL COOKING

Food will not cook any faster when a higher heat setting is used than needed to maintain a gentle boil. Water boils at the same temperature whether boiling gently or vigorously. If a high setting is used, excessive spattering will occur and food may stick or burn onto the bottom of the pan.

Use a higher heat setting to bring liquid to a boil or to begin cooking, then **reduce** to a lower setting. **Never leave food unattended during a cooking operation.**

Always place pan on the surface element before turning element on.

Never let a pan boil dry as this could damage the utensil and the appliance.

COOKWARE

Cooking performance is greatly affected by the type of cookware used. Cookware **SHOULD HAVE A FLAT BOTTOM**. The flat bottom allows good conductivity between the cookware and the element to provide uniform cooking results, faster heating and more efficient use of energy.

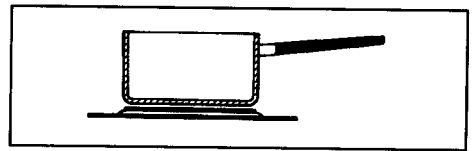

Cookware with uneven, warped, or grooved bottoms do not make good contact, will reduce heat conductivity and result in slower, less even heating. A pan with a badly curved bottom will not make good contact with the element and may not get enough heat to bring water to a boil.

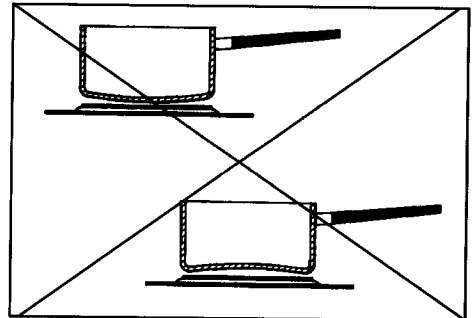

Fit the size of the cookware to the size of the element. This conserves energy. Oversized cookware or cookware that rest across two elements may trap enough heat to cause damage to the cooktop or elements.

Do not use woks equipped with round metal rings. The ring, which is designed to support the wok above the element, will trap heat and may damage the element and the cooktop.

USING YOUR COOKTOP

CANNING

Acceptable water-bath or pressure canners should not be oversized and must have a flat bottom. The following are **not recommended**: Canners with ridged bottoms, oversized canners (2-inches larger than the surface element) or a very large canner that rests on two surface elements.

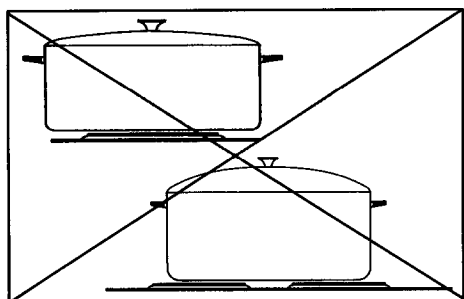

When canning, use the HIGH setting just until water comes to a boil or pressure is reached in the pressure canner. Then, **reduce** to the lowest heat setting that maintains the boil or pressure.

Prolonged use of the HIGH setting, or the use of incorrect canning utensils produce excessive heat. Excessive heat can cause permanent damage to the porcelain cooktop, surface element and the drip bowl.

Characteristics of Cookware

Materials:

Aluminum cookware heats quickly and evenly. Best suited for simmering, braising, boiling and frying. Do not use when cooking acid based foods such as spaghetti sauce.

Stainless Steel is a poor heat conductor and develops hot spots. If combined with other metals such as aluminum and copper, however, they will evenly distribute heat. Use for cooking functions similar to aluminum.

Cast Iron cookware is slow to heat and cooks more evenly once temperature is reached. Use for long term, low heat cooking or for browning and frying.

Glass ceramic, earthenware, heatproof glass or glazed cookware can be used if recommended by the manufacturer for range top cooking. Best used on low to medium heat settings. Follow manufacturer's directions for use on surface elements.

SUGGESTED HEAT SETTINGS

Use the following chart as a GUIDELINE until you become more familiar with your cooktop. Keep in mind that different types of cookware materials require different heat settings for the same cooking operation. We suggest that you experiment to find the heat setting that best suits your particular cooking needs. Information in the chart is based on heavy gauge aluminum cookware. Lower the heat setting if using stainless steel, cast iron utensils or glassware designed for surface cooking.

HEAT SETTINGS	USES
HI	To bring liquid to a boil, blanch, preheat skillet, or bring pressure up in pressure cooker. (Note: Always follow instructions in pressure cooker use and care book.) Always reduce to a lower heat setting when liquids just begin to boil or food begins to cook.
Medium-High 9 8 7	To brown or sear meat, heat oil for deep fat frying, scald. To fast saute or fry. Maintain fast boil for large amounts of liquids. For slower frying or sauteing operation.
Medium 6-5	To maintain moderate to slow boil for large amounts of liquids.
Medium-Low 4 3 2	To continue cooking uncovered foods and for most frying operations. To continue cooking covered foods and to maintain boil pressure in most pressure cookers. Stew, braise or steam operations. To maintain boil for small amounts of liquid, poach, steam or simmer.
LO	To keep foods warm before serving.

NOTE: Refer to cookware manufacturer's recommendations for suggested heat settings. Some manufacturers do not recommend the use of HIGH or the use of HIGH for extended cooking operations.

USING YOUR OVEN

OVEN CHARACTERISTICS

Every oven has its own characteristics. You may find that the cooking times and temperatures you were accustomed to with your previous range may need to be altered slightly with your new range. Please expect some differences with this new range.

OVEN CONTROLS

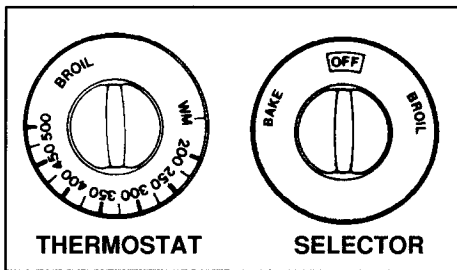

The THERMOSTAT knob is used to select and maintain the oven temperature. Always turn this knob just TO the desired temperature. Do not turn to a higher temperature and then back. On some models, there is an indent at the 350°F setting.

The SELECTOR knob determines the type of oven operation. Turn this knob to desired setting. Each setting is identified by an indent (stop) and a "click" sound.

To turn the oven on, **both** the Thermostat and Selector knobs must be set. The oven will not operate if the Selector knob is left in the OFF position. To turn the oven off, turn the selector knob to the OFF position.

OVEN INDICATOR LIGHT

The OVEN indicator light, located on the backguard, turns on whenever the selector knob is turned to BAKE or BROIL. When the oven reaches the preset temperature, the indicator light turns off and on as the oven elements cycle off and on.

OVEN RACKS

The two oven racks are designed with a "lock-stop" position to keep racks from accidentally coming completely out of the oven.

To remove: Be sure rack is cool. Pull rack out to the "lock-stop" position. Tilt up and continue pulling until rack releases.

To replace: Place rack on rack supports, tilt up and push toward rear of oven. Pull rack out to "lock-stop" position to be sure rack is correctly replaced.

RACK POSITIONS:

RACK 1 (top of oven) used for broiling thin non-fatty foods such as fish.

RACK 2 used for two-rack baking or broiling thicker cuts of meat.

RACK 3 used for most one-rack baking and for roasting some meats.

RACK 4 used for one or two rack baking and roasting large meats, cooking larger foods and for baking angel food cake or pie shells.

RACK 5 used for roasting turkey or baking angel food cake or pie shells.

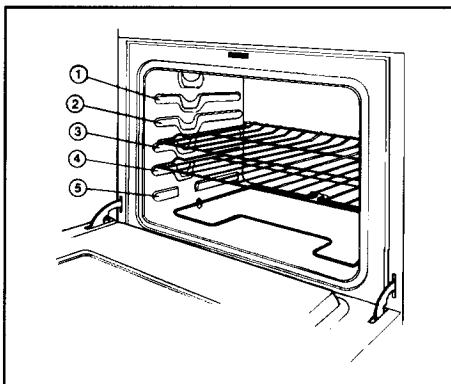

HINTS:

If cooking on two racks, stagger pans so one is not directly over the other. Use rack positions 2 and 4 or 2 and 5, when cooking on two racks.

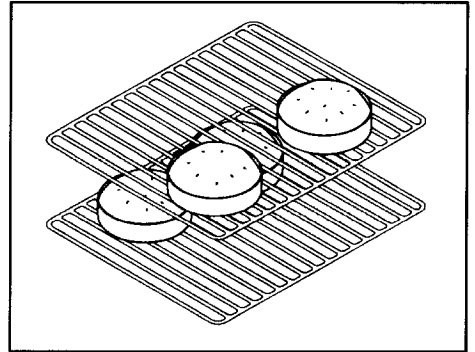

For optimum baking results of cakes, cookies or biscuits, use one rack. Position rack so food is in the center of the oven. Allow 2 inches between edge of utensil and the oven sides or adjacent utensils.

NEVER place pans directly on the oven bottom.

Do not cover entire rack with aluminum foil or place foil directly under cookware. To catch spillovers, cut a piece of foil a little larger than the pan and place it on the rack below the rack containing the pan.

PREHEATING

Preheating is necessary for baking. Allow oven to heat for 10 to 15 minutes before adding food. It is not necessary to preheat oven for roasting.

It is not necessary to preheat for broiling unless darker browning is desired or if cooking thin (3/4-inch) steaks. Allow broil element to preheat 3 to 5 minutes.

Selecting temperature higher than desired will **NOT** preheat the oven any faster. Preheating at a higher temperature may have a negative effect on baking results.

USING YOUR OVEN

HOW TO BAKE OR ROAST

1. When cool, position rack in oven depending on what you are baking.
2. **To set oven:** Turn thermostat knob to desired temperature and the selector knob to BAKE.
3. Place food in center of oven, allowing a minimum of 2 inches between utensil and oven walls.
4. Check food for doneness at minimum

time in recipe. Cook longer if necessary. Remove food from the oven and turn the selector knob to OFF. If you have carefully followed the basic instructions and still experience poor results, these suggestions may be helpful:

COMMON BAKING PROBLEMS AND WHY THEY HAPPEN

PROBLEM	CAUSE	PROBLEM	CAUSE
<i>Cakes are uneven.</i>	Pans touching each other or oven walls. Batter uneven in pans. Temperature set too low or baking time too short. Oven not level. Undermixing. Too much liquid.	<i>Cakes don't brown on top.</i>	Incorrect rack position. Temperature set too low. Overmixing. Too much liquid. Pan size too large or too little batter in pan. Oven door opened too often.
<i>Cake high in middle.</i>	Temperature set too high. Baking time too long. Overmixing. Too much flour. Pans touching each other or oven walls. Incorrect rack position.	<i>Excessive shrinkage.</i>	Too little leavening. Overmixing. Pan too large. Temperature set too high. Baking time too long. Pans too close to each other or oven walls.
<i>Cake falls.</i>	Too much shortening or sugar. Too much or too little liquid. Temperature set too low. Old or too little baking powder. Pan too small. Oven door opened frequently. Added incorrect type of oil to cake mix. Added additional ingredients to cake mix or recipe.	<i>Uneven texture.</i>	Too much liquid. Undermixing. Temperature set too low. Baking time too short.
<i>Cakes, cookies, biscuits don't brown evenly.</i>	Incorrect rack position. Oven door not closed properly. Door gasket not sealing properly. Incorrect use of aluminum foil. Oven not preheated. Pans darkened, dented or warped.	<i>Cakes have tunnels.</i>	Not enough shortening. Too much baking powder. Overmixing or at too high a speed. Temperature set too high.
		<i>Cakes crack on top.</i>	Batter overmixed. Temperature set too high. Too much leavening. Incorrect rack position.
		<i>Cake not done in middle.</i>	Temperature set too high. Pan too small. Baking time too short.
If additional ingredients were added to mix or recipe, expect cooking time to increase.			
<i>Cakes, cookies, biscuits too brown on bottom.</i>	Oven not preheated. Pans touching each other or oven walls. Incorrect rack position. Incorrect use of aluminum foil. Placed 2 cookie sheets on one rack. Used glass, darkened, stained, warped or dull finish metal pans. (Use a shiny cookie sheet.)	<i>Pie crust edges too brown.</i>	Temperature set too high. Pans touching each other or oven walls. Edges of crust too thin.
Follow cookware manufacturer's instructions for oven temperature. Glassware and dark cookware such as Ecco's Baker's Secret require lowering the oven temperature by 25° F.			
		<i>Pies don't brown on bottom.</i>	Used shiny metal pans. Temperature set too low.
		<i>Pies have soaked crust.</i>	Temperature too low at start of baking. Filling too juicy. Used shiny metal pans.

USING YOUR OVEN

HOW TO BROIL

Broiling is a method of cooking tender meats by direct heat under the element. The cooking time is determined by the distance between the meat and the element, the desired degree of doneness and the thickness of the meat.

Broiling requires the use of the broiler pan and insert. The correct position of the insert in the pan is very important. The broiler insert should be placed in the pan so grease will drain freely. Improper use may cause grease fires.

The broiler insert CANNOT be covered with aluminum foil as this prevents fat from draining into pan below. However, for easier cleaning, the broiler pan can be lined with foil.

Do not use disposable broiler pans. They do not provide a separate tray.

Preheat broil element 5 to 10 minutes if darker browning is desired.

TO BROIL:

1. Prepare meat by removing excess fat and slashing remaining fat, being careful not to cut into meat. This will help keep meat from curling.
2. Place broiler pan on the recommended rack position. For brown exterior and rare interior, the meat should be close to the element. Place further down if you wish meat well done. Excessive smoking may occur if meat is placed too close to the broil element.
3. To set oven: Turn both the thermostat and selector knobs to BROIL.

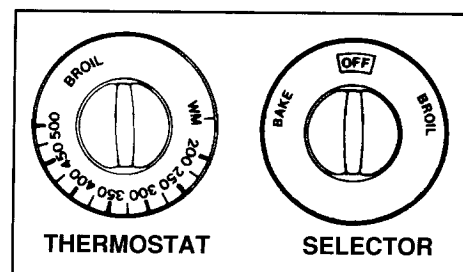

4. Broiling should be done with oven door opened to the broil "STOP" position (opened about 4 inches.).
5. Follow suggested times on broiling chart. Meat should be turned once about half way through cooking.
6. Check doneness by cutting a slit in meat near center for desired color.
7. Turn the selector knob to OFF after cooking. Broil times may need to be increased if range is installed on a 208-volt circuit.

BROILING CHART

TYPE OF FOOD	RACK POSITION	DONENESS	TOTAL TIME
BACON	#2	Well Done	6 to 10 minutes
BEEF STEAKS 1-inch thick	#2	Rare Medium Well Done	10 to 14 minutes 15 to 18 minutes 19 to 22 minutes
1 1/2-inch thick	#2 #2 #3	Rare Medium Well Done	18 to 20 minutes 22 to 24 minutes 25 to 30 minutes
CHICKEN Whole, split Pieces	#3 #3	Well Done Well Done	BROIL AT 450°F 45 to 60 minutes 30 to 45 minutes
FISH STEAK OR FILLET 1/2-inch thick	#2	Flaky	10 to 12 minutes
GROUND BEEF PATTIES 3/4 to 1-inch thick	#2	Rare Medium Well Done	10 to 13 minutes 12 to 15 minutes 15 to 18 minutes
HAM SLICE, precooked 1-inch thick 1 1/2-inch thick	#2 #2		12 to 16 minutes 21 to 26 minutes
LAMB CHOPS 1-inch thick	#2	Medium Well Done	12 to 15 minutes 16 to 20 minutes
1 1/2-inch thick	#3	Medium Well Done	15 to 19 minutes 25 to 30 minutes
PORK CHOPS 3/4-inch thick 1-inch thick	#2 #2	Well Done Well Done	15 to 20 minutes 20 to 25 minutes
WIENERS, precooked Hot dogs, smoked or Polish sausage, Bratwurst, etc.	#2		8 to 12 minutes
BREADS Toast Toaster Pastries English Muffins, buttered	#2 #2 #2		TIME PER SIDE 5 to 8 minutes/side 5 to 8 minutes/side 5 minutes

MAINTENANCE

LIGHT REPLACEMENT

Before replacing oven light bulb, DISCONNECT POWER TO RANGE. Be sure bulb is cool. Do not touch a hot bulb with a damp cloth as the bulb may break.

Very carefully remove bulb with a dry potholder to prevent possible harm to hands. Replace with a 40 watt appliance bulb. Reconnect power to range and reset clock, if equipped.

STORAGE DRAWER

The storage drawer at the bottom of the range is safe and convenient for storing metal and glass cookware. DO NOT store plastic, paperware, food or flammable material in this drawer. Remove drawer to clean under range.

To remove: Empty drawer then pull drawer out to the first stop position. Lift up front of drawer and pull to the second stop position. Grasp sides and lift up and out to remove drawer.

To replace: Fit ends of drawer glides onto rails. Lift up drawer front and gently push in to first stop position. Lift up drawer again and continue to slide drawer to the closed position.

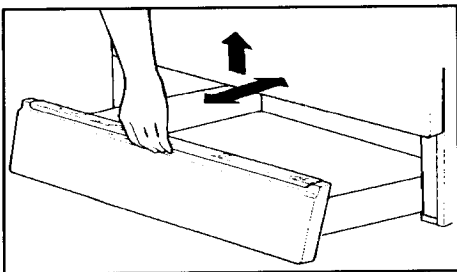

OVEN DOOR

Do not place excessive weight on an open oven door or stand on an open oven door as, in some cases, it could cause the range to tip over, breakage of the door or serious injury.

When opening oven door, allow steam and hot air to escape before reaching in oven to check, add or remove food.

To remove lift-off door: Open door to the "stop" position (opened about 4 inches) and grasp door with both hands at each side. Do not use door handle to lift door. Lift up evenly until door clears the hinge arms.

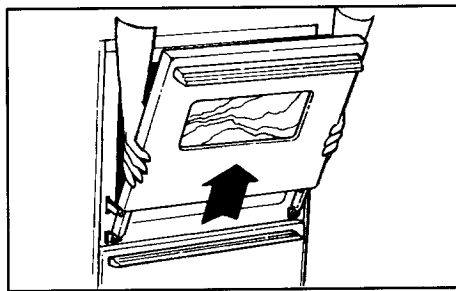

CAUTION:

Hinge arms are spring mounted and will slam shut against the range if accidentally hit. **Never place hand or fingers between the hinges and the front oven frame.** You could be injured if hinge snaps back.

To replace door: Grasp door at each side, align slots in the door with the hinge arms and slide door down onto the hinge arms until completely seated on hinges.

Do not attempt to open or close door until door is completely seated on hinge arms. Never turn on oven unless door is properly in place. When baking, be sure door is completely closed. Baking results will be affected if door is not securely closed.

LEVELING LEGS

Some floors are not level. For proper baking, your range must be level. Leveling legs are located on each corner of the base of the range. Level by turning the legs.

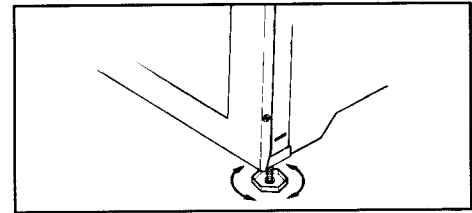

To prevent range from accidentally tipping, range should be secured to the floor by sliding rear leveling leg into the anti-tip bracket supplied with the range.

FUSES

(CANADIAN RANGES ONLY)

Your range is equipped with seven (7) type "P" fuses. The fuses are located on the back wall of the range. Remove the storage drawer for access to the fuses.

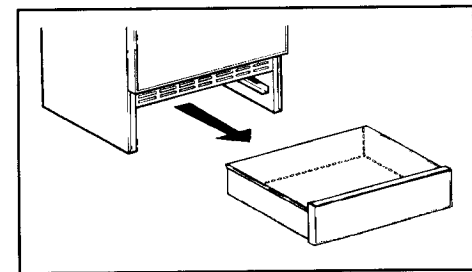

If part of your range does not operate, check to see if a fuse has blown. A gap in the fuse strip or a darkened window indicates a blown fuse. Replace with the same type and amperage type "P" fuse.

CARE AND CLEANING

PARTS	CLEANING AGENTS	DIRECTIONS Be sure all parts are cool before cleaning. Be sure all parts are properly replaced after cleaning.
Broiler pan & insert	Soap & water. Plastic scouring pad. Soap filled scouring pad.	Remove from oven after use. Cool then pour off grease. Place soapy cloth over insert and pan; let soak to loosen soil. Wash in warm soapy water. Use soap filled scouring pad to remove stubborn soil. Clean in dishwasher if desired.
Baked Enamel: Side panels Backguard Oven door Storage drawer	Soap & water. Paste of baking soda & water.	Use a dry paper towel or cloth to wipe up spills, especially acid spills, as soon as they occur. (This is especially important for white surfaces.) When surface is cool, wash with soap and water. Do not use abrasive or harsh cleaning liquids and powders or oven cleaners. These will scratch and permanently damage the finish. Dry with a soft cloth.
Control knobs	Mild detergent & water.	To remove knobs, gently pull forward. Wash in mild detergent and water. Do not use abrasive cleaning agents. They will scratch finish and remove markings. Rinse, dry and replace. Turn each element ON to see if knobs have been replaced correctly.
Glass: Backguard Oven window	Soap & water. Paste of baking soda & water. Window cleaning fluid.	Wash with soap and water. Remove stubborn soil with paste of baking soda and water. Do not use abrasive materials such as scouring pads, steel wool or powdered cleaning agents. They will damage glass. Rinse with clear water and dry. To prevent staining of oven window, never use excessive amounts of water which may seep under or behind glass.
Metal finishes: Aluminum – backguard base. Chrome & stainless steel – trim parts	Soap & water. Paste of baking soda & water.	Wash with soap and water. Remove stubborn soil with paste of baking soda and water. Do not use oven cleaners, abrasive or caustic agents. They will damage the finish.
Oven racks	Soap & water. Cleansing powders & plastic pads. Soap filled scouring pad.	Clean with soapy water. Remove stubborn soil with cleansing powder or soap filled scouring pad. Rinse and dry.
Plastic finishes: Door handle, Trim, Backguard trim, Overlay, Knobs, or End caps	Soap & water. Paste of baking soda and water. Non-abrasive plastic pad or sponge.	Do not use oven cleaner, powder or liquid cleansers, abrasive or caustic cleaning agents on plastic finishes. These cleaning agents will scratch or mar finish. To prevent staining or discoloration, wipe up fat, grease or acid (tomato, lemon, vinegar milk, fruit juice, marinade) immediately with a dry paper towel or cloth. When surface is cool, clean with soap and water; rinse, and dry.
Porcelain enamel: Cooktop Oven interior See page 5 for continuous clean oven.	Mild liquid cleaners, detergent or soap & water. Cleansing powders and non abrasive nylon or plastic pads. Do not use oven cleaner on continuous clean oven.	Porcelain enamel is glass fused on metal. It may crack or chip with misuse. Clean with soap and water when parts are cool. All spillovers, especially acid or sugar spillovers, should be wiped up immediately with a dry cloth. Surface may discolor or dull if soil is not removed. When surface is cool, clean with warm soapy water. NEVER WIPE OFF A WARM OR HOT ENAMEL SURFACE WITH A DAMP CLOTH. THIS MAY CAUSE CRACKING AND CHIPPING. Never use abrasive or caustic cleaning agents on exterior finish of range. Use commercial oven cleaner on porcelain – lined oven ONLY . Carefully read and follow manufacturer's instructions. NOTE: The cooktop on coil models lifts up for access to area under the cooktop.
Silicone rubber door gasket	Soap & water.	Door gasket is located on the door plug. DO NOT REMOVE GASKET. Wash with soap. Rinse thoroughly.
Surface & Oven Elements		Elements are self cleaning. Soil will burn off as elements are used. Do not spray oven cleaner on elements, electrical hook up or connection.

SERVICE

PART OR ALL OF YOUR RANGE DOES NOT OPERATE	Is the range plug disconnected from the electrical outlet? • Are house fuses blown or circuit breakers tripped? • Is the range plug loose or improperly plugged in? Has power supply to your home been interrupted? • Was oven properly set?
SURFACE ELEMENTS FAIL TO TURN ON OR HEAT FOOD PROPERLY	Is range plug disconnected from the electrical outlet? Check circuit breaker or fuse box for tripped circuit breakers or blown fuses. • Is element properly plugged into receptacle? • Was incorrect pan used? For optimum results, pan SHOULD HAVE A FLAT bottom. See pages 6 and 7 for additional information. (NOTE: Expect cooking times to increase if range is connected to 208 volts). • Have serviceman check element.
FOOD NOT BAKING SATISFACTORILY	Are racks properly in place and in correct position for what you are baking? • Is range level? • Are you using the proper pan? Is it bright, not soiled or dark colored? • Have you used foil incorrectly? • Are you using standard measuring utensils? • Did you preheat if recommended? • Oven temperature is incorrectly set – too low or too high. See Common Baking Problem chart on page 9.
OVEN DOES NOT OPERATE	Is the range disconnected from the electrical power? • Was the Selector knob turned to bake or broil? • Was oven properly set?
OVEN LIGHT DOES NOT WORK	Is bulb loose or burned out?

SERVICE

Do not attempt to service the appliance yourself unless directed to do so in this book. Contact the dealer who sold you the appliance for service.

HOW TO OBTAIN SERVICE

When your appliance requires service or replacement parts, contact your Dealer or Authorized Servicer. Use only genuine factory or Maycor parts if replacement parts are necessary. Consult the Yellow Pages in your telephone directory under appliance for the service center nearest you. Be sure to include your name, address, and phone number, along with the model and serial numbers of the appliance. (See front

cover for location of your model and serial numbers.)

If you are unable to obtain service, write to us. Our address is found on the rating plate. See front cover for location of rating plate.

If you are not satisfied with the local response to your service requirements, call or write MAYCOR Appliance Parts and Service Company, 240 Edwards Street, S.E., Cleveland, TN 37311, (615) 472-3500. Include or have available the complete model and serial numbers of the appliance, the name and address of the dealer from whom you purchased the appliance, the date of purchase and details concerning your problem.

If you did not receive satisfactory service through your servicer or Maycor you may contact the Major Appliance Consumer Action Panel by letter including your name, address, and telephone number, as well as the model and serial numbers of the appliance.

Major Appliance Consumer Action Panel
20 North Wacker Drive
Chicago, IL 60606

MACAP (Major Appliance Consumer Action Panel) is an independent agency sponsored by three trade associations as a court of appeals on consumer complaints which have not been resolved satisfactorily within a reasonable period of time.

FULL ONE-YEAR WARRANTY

DOMESTIC GAS OR ELECTRIC RANGE

Maycor Appliance Parts & Service Company will repair or replace, without charge, any part of your product which has a defect in material or workmanship during the first year after the date of the original installation. This warranty extends to any owner during the one-year warranty period.

LIMITED 5 YEAR WARRANTY

On electric ranges equipped with solid disc or smoothtop heating elements, and on gas ranges with sealed burners, for an additional 4 year period beyond the first year of the general coverage of this warranty, Maycor will replace any of the solid disc or smoothtop heating elements, or sealed burners which fail to heat as a result of defective workmanship or material. Additionally, Maycor will replace any smoothtop cooking surface which cracks or breaks during normal household cooking. These parts must be installed by a qualified person. Any labor charge required for replacement is not covered by this warranty.

HOW TO OBTAIN SERVICE

To obtain the repair or replacement of a defective part under these warranties, you should contact the dealer from whom you purchased the appliance or a servicer he designates.

WHAT IS NOT COVERED BY THESE WARRANTIES

1. Conditions and damage resulting from improper installation, delivery, unauthorized repair, modification, or damage not attributable to a defect in material or workmanship.
2. Conditions resulting from damage, such as: (1) improper maintenance, (b) misuse, abuse, accident, or (c) incorrect electrical current or voltage.
3. Warranties are void if the original serial number has been removed, altered, or cannot be readily determined.
4. Light bulbs.
5. Any product used for other than normal household use. It does not extend to products purchased for commercial or industrial use.
6. Any expense incurred for service calls to correct installation errors or to instruct you on how to use the products.
7. CONSEQUENTIAL OR INCIDENTAL DAMAGES SUSTAINED BY ANY PERSON AS A RESULT OF ANY BREACH OF THESE WARRANTIES OR ANY IMPLIED WARRANTY. Some states do not allow the exclusion or limitation of consequential or incidental damages, so the above exclusion may not apply to you.

ADDITIONAL HELP

If you are not satisfied with the local response to your service requirements and wish to contact Maycor, please address your letter to the Customer Relations Department, Maycor Parts & Service Company, 240 Edwards Street, S.E., Cleveland, TN 37311 or call (615) 472-3500. To save time, your letter should include the complete model and serial numbers of the warranted appliance, the name and address of the dealer from whom you purchased the appliance, the date of purchase and details concerning your problem.

These warranties are the only written or expressed warranties given by Maycor. No one is authorized to increase, alter, or enlarge Maycor's responsibilities or obligations under these warranties. These warranties give you specific legal rights, and you may also have other rights which vary from state to state.

8109P059-60
(6/91)