

Use

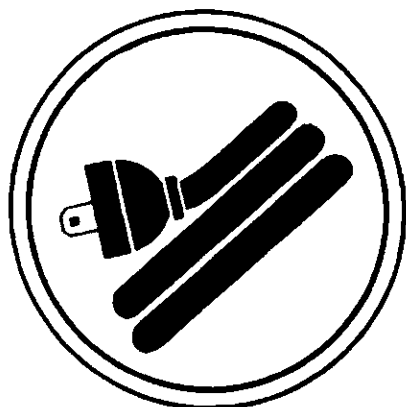

And

Care

Instructions for your Electric Smoothtop Range with "T" Clock

CONTENTS

SAFETY INSTRUCTIONS	1-3	USING YOUR OVEN	10-12
ELECTRONIC CONTROLLER	4	Oven characteristics	10
FEATURES	5-6	Fan	10
Self-clean oven	5	Preheating	10
Automatic oven cooking	6	How to bake or roast	11
USING YOUR SMOOTHTOP	7-9	Common baking problem chart	11
Cooking areas	7	How to broil	12
Surface controls	7	MAINTENANCE	13
Signal lights	7	Light replacement	13
Hot surface light	7	Storage drawer	13
Retained heat	7	Oven door	13
Hints	7	Leveling legs	13
Cookware	8	Fuses (Canada only)	13
Heat setting chart	8	CARE AND CLEANING CHART	14
Care information	9	SERVICE	15
		Troubleshooting	15
		WARRANTY	18

INSTALLER Please leave this manual with this appliance.

CONSUMER To save you time, energy and money, read and keep this manual for future reference.

The model and serial numbers of your appliance are found on the rating plate which is located behind the storage drawer on the front frame.

Model number: _____

Serial number: _____

Date of purchase: _____

SAFETY INSTRUCTIONS

Information in the Safety Instruction section covers all electric cooking appliances. You may find some information that does not pertain to your particular appliance. Please review this section before using your cooking appliance.

The following instructions are based on safety considerations and must be strictly followed to eliminate the potential risks of fire, electric shock, or personal injury.

PROPER INSTALLATION – Be sure your appliance is properly installed and grounded by a qualified technician.

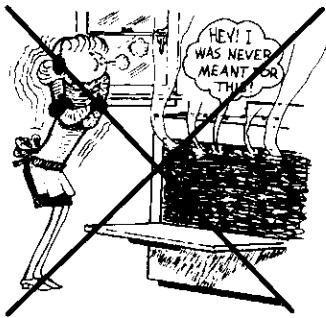

NEVER USE YOUR APPLIANCE FOR WARMING OR HEATING THE ROOM.

STORAGE ABOVE RANGE – To eliminate the hazard of reaching over hot surface elements, cabinet storage should not be provided directly above a unit. If provided, storage should be limited to infrequently used items that can be safely stored in an area subjected to heat. Temperatures may be unsafe for some items such as volatile liquids, cleaners, or aerosol sprays. If cabinet storage is provided, installation of a range hood that projects at least 5-inches beyond the bottom of the cabinet will reduce the hazards associated with such storage.

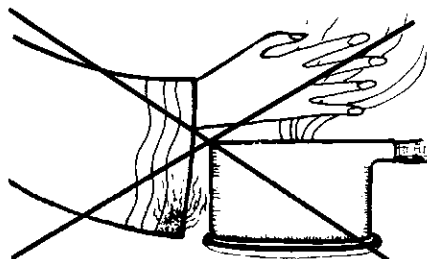

WEAR PROPER APPAREL – Loose-fitting or hanging garments should never be worn while using the appliance.

USER SERVICING – Do not repair or replace any part of the appliance unless specifically recommended in the Use and Care Book. All other servicing should be referred to a qualified technician. Always disconnect unit or cut-off power to unit before any servicing.

STORAGE IN, ON OR NEAR APPLIANCE – Do not store or use gasoline or other flammable materials, vapors and liquids in the oven, near surface units or in the vicinity of this or any other appliance. The fumes can create a fire hazard or explosion. Do not use cooktop or oven as a storage area for food or cooking utensils.

DO NOT USE WATER ON GREASE FIRES – Smother fire or flame or use dry chemical or foam-type extinguisher, if available or sprinkle heavily with baking soda.

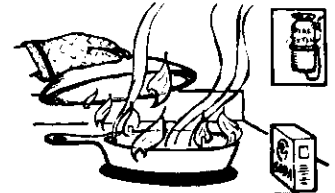

USE ONLY DRY POTHOLDERS – Moist or damp potholders on hot surfaces may result in burns from steam. Do not let potholder touch hot heating elements. Do not use a towel or other bulky cloths.

SURFACE COOKING UNITS:

USE PROPER PAN SIZE – This appliance is equipped with one or more surface elements of different sizes. Select utensils having flat bottoms large enough to cover the surface element. The use of undersized utensils will expose a portion of the heating element to direct contact and may result in ignition of clothing. Proper relationship of utensil to element will also improve efficiency.

NEVER LEAVE SURFACE UNITS UNATTENDED AT HIGH HEAT SETTINGS – Boilover causes smoking and greasy spillovers that may ignite.

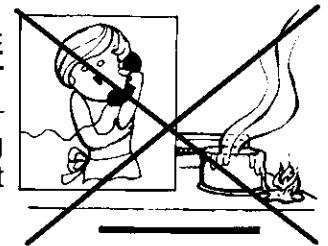

MAKE SURE DRIP BOWLS ARE IN PLACE – Absence of these bowls during cooking may subject wiring or components underneath to damage.

PROTECTIVE LINERS – Do not use aluminum foil to line surface unit drip bowls or oven bottoms, except as suggested in the Use and Care Book. Improper installation of these liners may result in a risk of electric shock, or fire.

SAFETY INSTRUCTIONS

GLAZED COOKING UTENSILS – Only certain types of glass, glass/ceramic, ceramic, earthenware, or other glazed utensils are suitable for range-top service without breaking due to the sudden change in temperature.



UTENSIL HANDLES SHOULD BE TURNED INWARD AND NOT EXTEND OVER ADJACENT SURFACE UNITS –

To reduce the risk of burns, ignition of flammable materials, and spillage due to unin-

tentional contact with the utensil, the handle of a utensil should be positioned so that it is turned inward, and does not extend over adjacent surface elements.

DO NOT SOAK REMOVABLE HEATING ELEMENTS – Heating elements should never be immersed in water. Immersing element in water would damage insulating material inside element.

OVENS:

USE CARE WHEN OPENING DOOR – Let hot air or steam escape before removing or replacing food.

DO NOT HEAT UNOPENED FOOD CONTAINERS – Build-up of pressure may cause container to burst and result in injury.

KEEP OVEN VENT DUCTS (located under rear element; rear corner of cooktop; between oven door and control panel of wall oven or on backguard) **UNOBSTRUCTED**. Blockage of vent prevents proper oven air circulation and will affect oven performance. Avoid touching oven vent area while oven is on and for several minutes after oven is turned off. Some parts of the vent and surrounding area become hot enough to cause burns.

PLACEMENT OF OVEN RACKS – Always place oven racks in desired location while oven is cool. If rack must be moved while hot, use care to avoid contact of potholder with oven element.

VENTILATING HOODS:

CLEAN VENTILATING HOODS FREQUENTLY – Grease should not be allowed to accumulate on hood or filter. When flaming foods under the hood, turn the fan off. The fan, if operating, may spread the flame.

IMPORTANT SAFETY NOTICE AND WARNING

The California Safe Drinking Water and Toxic Enforcement Act of 1986 (Proposition 65) requires the Governor of California to publish a list of substances known to the State of California to cause cancer or reproductive harm, and requires businesses to warn customers of potential exposures to such substances.

Users of this appliance are hereby warned that when the appliance is engaged in the self-clean cycle there may be some low-level exposure to some of the listed substances, including carbon monoxide. Exposure to these substances can be minimized by properly venting the appliance to the outdoors during the self-clean cycle.

DEEP FAT FRYERS:

Use extreme caution when moving the grease kettle or disposing of hot grease.

DO NOT TOUCH SURFACE ELEMENTS OR OVEN ELEMENTS, AREAS NEAR ELEMENTS OR INTERIOR SURFACES OF OVEN – Elements may be hot even though they are dark in color. Areas near surface elements and interior surfaces of oven may become hot enough to cause burns. During and after use, do not touch or let clothing or other flammable materials contact heating elements, areas near elements or interior surfaces of oven until they have had sufficient time to cool. Among these areas are the cooktop, surfaces facing the cooktop, oven vent opening and surfaces near this opening, oven door, and oven window. Also, do not allow aluminum foil, meat probes or any other metal object, other than a utensil on a surface element, to contact heating elements.

ANTI-TIP BRACKET:

WARNING: To reduce the risk of tipping of the appliance from unusual usage or by excessive loading of the oven door, the appliance must be secured by a properly installed anti-tip device. To check if device is installed properly: Use a flashlight and look underneath range to see that one of the rear leveling legs is engaged in the bracket slot. When removing appliance for cleaning, be sure anti-tip device is engaged when range is replaced. The anti-tip device secures the rear leveling leg to the floor, when properly engaged.

SAFETY INSTRUCTIONS

ADDITIONAL INFORMATION:

After appliance is installed, be certain all packing materials are removed from the appliance before operating the unit. If appliance is installed near a window, take steps to prevent curtains from blowing over surface elements creating a fire hazard.

Care should be given to location of appliance. Be sure floor covering under appliance, walls adjacent to appliance, cabinetry adjacent to appliance, and other materials adjacent to appliance can withstand prolonged heat. This is a heavy appliance and can settle into soft floor coverings such as cushioned vinyl. Use care when moving range on this type of floor covering.

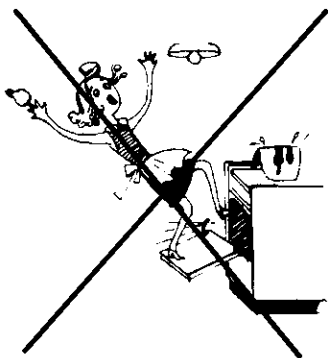

OVEN DOOR

Do not place excessive weight on an open oven door or stand on an open oven door as, in some cases, it could cause the range to tip over, breakage of the door or serious injury.

CIRCUIT BREAKER OR FUSE – Locate and mark circuit breaker or fuse. Never replace a blown fuse or reset a breaker until you know what has caused the problem. Always replace a blown fuse with one of the correct amperage, do not use a substitute.

CONTROL KNOBS – Turn off control at the completion of a cooking operation.

SELF-CLEANING OVEN:

Do not clean door gasket. The door gasket is essential for a good seal. Care should be taken not to rub, damage, or move the gasket. Do not use oven cleaners or oven liner protective coating of any kind in or around any part of the self-clean oven. Clean only parts listed in this booklet. Before self-cleaning the oven, remove broiler pan, oven racks, and other utensils.

CAUTION: DO NOT LEAVE FOOD OR COOKING UTENSILS, ETC., IN OVEN DURING THE SELF-CLEANING MODE OF OPERATION.

ATTENTION: NE LAISSER AUCUN ALIMENT, US-TENSILE DE CUISINE, ETC., DANS LE FOUR DURANT LE CYCLE D'AUTONETTOYAGE.

On some models, a fan should be heard during the self-clean cycle. If not, cancel clean cycle and call a serviceman before self-cleaning again. (Refer to CONTENTS on front cover for location of self-clean instructions and fan information.)

SMOOTHTOP COOKTOP:

Do not cook on broken cooktop. If cooktop should break, cleaning solutions and spillovers may penetrate the broken cooktop and create a risk of electric shock. Contact a qualified technician immediately. Clean cooktop with caution. If a wet sponge or cloth is used to wipe spills on a hot cooking area, be careful to avoid steam burn. Some cleaners can produce noxious fumes if applied to a hot surface.

DO NOT LEAVE CHILDREN ALONE – Children should not be left alone or unattended in area where appliance is in use. They should never be allowed to sit or stand on any part of the appliance. **CAUTION:** Do not store items of interest to children in cabinets above an appliance or on the backguard of a range.

Children climbing on the appliance to reach items could be seriously injured. Children must be taught that the appliance and utensils in or on it can be hot. Children should be taught that an appliance is not a toy. They should not be allowed to play with controls or other parts of the unit.

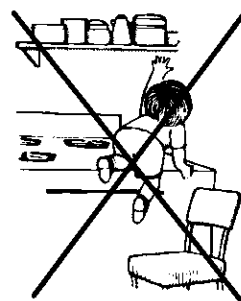

IN CASE OF FIRE:

1. Turn off appliance and ventilating hood.
2. Use dry or foam-type extinguisher or baking soda to smother flame. Never use water on a grease fire.
3. If fire is in oven, smother by closing oven door.
4. If fire is in a pan on the surface unit, cover pan.

– SAVE THESE INSTRUCTIONS –

ELECTRONIC CONTROLLER

CLOCK (time-of-day)

1. Press CLOCK pad.
2. Turn SET knob until display shows correct time-of-day.
3. Press STOP/CLEAR pad to lock in time.

When power is first supplied to oven or if there has been a power failure, the display will flash. Follow above instructions to set clock.

CLEAN

1. Close door.
2. Move door lock lever to locked position.
3. Press CLEAN pad. ("door" will flash in display and beeps will sound if door is not locked.)
4. Oven will automatically clean for 3 hours. Select 2 or 4 hours by turning the SET knob.

See page 5 for additional information.

BROIL

1. Press BROIL pad.
2. Turn SET knob clockwise to select HI broil or counter clockwise to select LO broil.
3. Press STOP/CLEAR pad to cancel broil operation.

See page 12 for additional information.

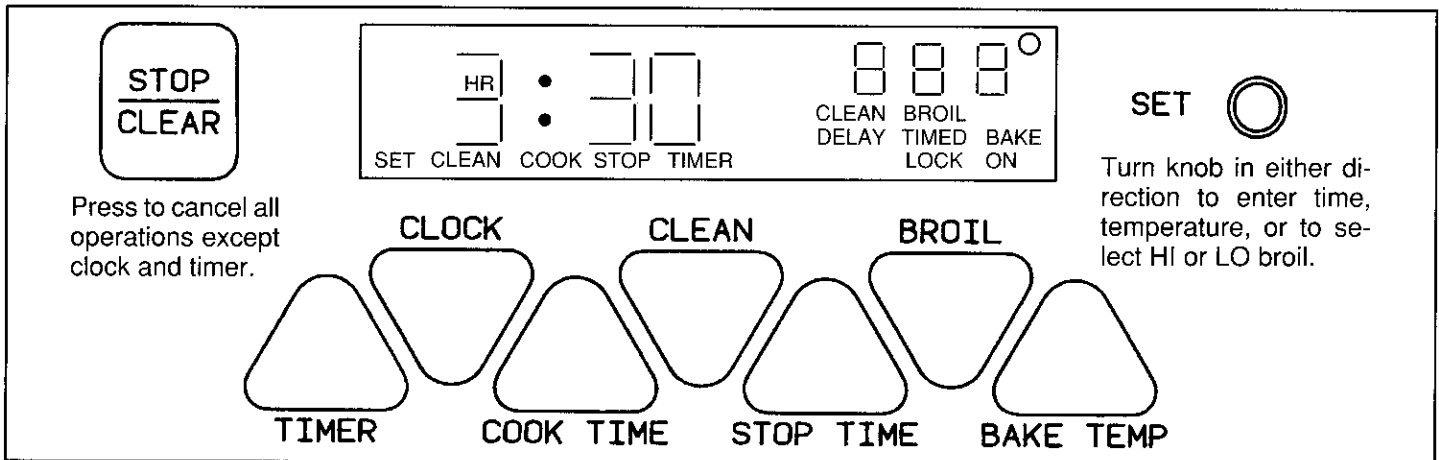

(NOTE: All indicator words are displayed to show their location. When oven or timer is not in use, indicator words are not displayed. Indicators are only displayed when oven is set for a cook, delayed cook, clean or timer operation.)

TIMER (minute timer)

1. Press TIMER pad.
2. Turn SET knob to desired time.
3. TIMER starts automatically. 3 beeps signal the end of the timing operation and the time-of-day reappears in the display.
4. **To cancel:** Press TIMER pad and hold for 3 seconds or turn SET knob until :00 appears in the display. Time-of-day will reappear after a slight delay.

ADDITIONAL INFORMATION

A beep sounds each time a pad is pressed. Three beeps signal the end of an operation.

If a fault code (ex: F 2) is displayed and beeps sound, press STOP/CLEAR if fault code continues, see page 15.

Function pads on some models are round – they operate as described in this booklet.

COOK TIME/STOP TIME

To begin cooking immediately:

1. Press BAKE TEMP pad and enter oven temperature with SET knob.
2. Press COOK TIME pad and enter desired cooking time by turning the SET knob.

To delay the start of cooking:

1. Press BAKE TEMP pad and enter oven temperature with SET knob.
2. Press COOK TIME pad and enter cooking time with SET knob.
3. Press STOP TIME pad and enter time you wish food to stop cooking with SET knob.

The oven will automatically turn on and off at the preset times.

Press STOP/CLEAR pad to cancel end-of-cooking beeps. See page 6 for additional information.

BAKE TEMP

1. Press BAKE TEMP pad.
2. Turn SET knob until desired oven temperature appears in the display.
3. Press STOP/CLEAR pad to cancel the baking operation.

See pages 10 to 11 for additional information on baking and roasting.

TO CANCEL AN OPERATION:

Press STOP/CLEAR pad to cancel a cook or clean operation.

FEATURES

SELF-CLEAN OVEN

The self-clean oven uses temperatures above normal cooking temperatures to automatically clean the entire oven.

TO OPERATE:

1. Close door and move door lock lever to the right (locked position).

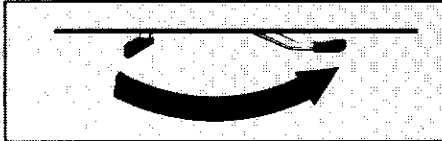

2. Press CLEAN pad.

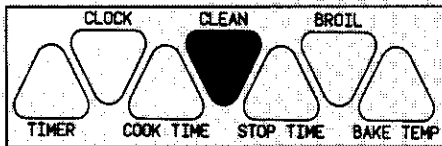

If door is not locked as described, "door" will flash in the display.

3. When the CLEAN pad is pressed, the oven will automatically clean for 3 hours.

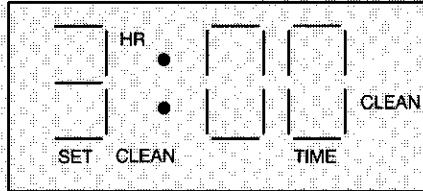

A shorter (2 hour) or longer (4 hour) clean cycle can be selected by turning the SET knob.

TO CANCEL CLEAN CYCLE:

1. Push STOP/CLEAR pad.
2. If the LOCK indicator is not displayed, the oven door can be unlocked.

If the LOCK indicator is displayed, allow oven to cool (up to one hour). Once LOCK indicator turns off, the door can be unlocked.

Door and lock lever may be damaged if the lock lever is forced to the left before the LOCK indicator turns off.

BEFORE SELF-CLEANING

Remove all pans from the oven. The racks may be left in, but will discolor and may not slide easily after cleaning.

Clean oven frame, door frame and around the oven vent with a non-abrasive cleaning agent such as Bon Ami. These areas are not exposed to cleaning temperatures and should be cleaned to prevent soil from baking on during the clean cycle.

Wipe up excess grease or spillovers from the oven bottom to prevent excessive smoking during the clean cycle.

DO NOT USE OVEN CLEANERS OR OVEN LINER PROTECTIVE COATINGS OF ANY KIND ON THE SELF-CLEAN OVEN FINISH OR AROUND ANY PART OF THE OVEN.

To prevent damage, do not clean or rub the gasket around the oven door. The gasket is designed to seal in heat during the clean cycle.

DURING SELF-CLEANING

When the door is locked and the CLEAN pad is pressed, the oven automatically begins to heat to cleaning temperatures.

As the oven reaches cleaning temperatures, the LOCK indicator will turn on to show that an internal lock mechanism has engaged. At this point, the oven door can not be unlocked and opened.

To prevent damage to the door and lock lever, do not force the lock lever to the left when the LOCK indicator is displayed.

About one hour after the completion of the clean cycle, the internal lock will disengage and the LOCK indicator will turn off. At this point, the lock lever can be moved to the left (unlocked position) and the door opened.

The first few times the oven is cleaned, some smoke and odor may be detected. This is normal and will reduce or disappear with use. If the oven is heavily soiled, or if the broiler pan is left in the oven, smoke and odor may occur.

It is normal for the cooktop of the range to become hot during a clean cycle. Therefore touching the cooktop during a self-clean cycle should be avoided.

As the oven heats and cools, you may hear sounds of metal parts expanding and contracting. This is normal and will not damage your appliance.

AFTER SELF-CLEANING

Some soil may leave a light gray, powdery ash which can be removed with a damp cloth. If soil remains, it indicates that the clean cycle was not long enough. The soil will be removed during the next clean cycle.

If the oven racks do not slide smoothly after a clean cycle, wipe racks and embossed rack supports with a small amount of vegetable oil to restore ease of movement.

Fine, hair-like lines may appear in the oven interior or oven door. This is a normal condition resulting from heating and cooling of the porcelain finish. These lines do not affect the performance of the oven.

FEATURES

AUTOMATIC OVEN COOKING

Automatic cooking feature is used to turn the oven on and off at the preset time-of-day. This feature can be used to delay the start of a cooking operation.

The automatic cooking feature will not operate unless the clock is functioning and is set at the correct time-of-day.

TO BAKE BY TIME with immediate START:

1. Press BAKE TEMP pad. "BAKE" lights in the display.
2. Enter oven temperature with the SET knob.
3. Press COOK TIME pad. "SET COOK TIME" flashes in the display.
4. Enter cooking time (how long you wish food to cook) with the SET knob.
"TIMED BAKE ON" lights in the display. The oven automatically turns on and the display begins to count down.
5. At the end of the preset cooking time, the oven automatically turns off.
6. Press STOP/CLEAR pad to cancel end-of-cooking beeps.

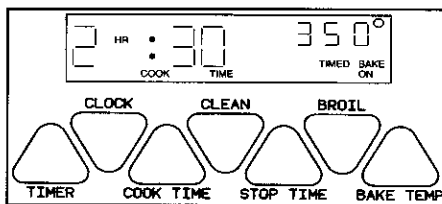
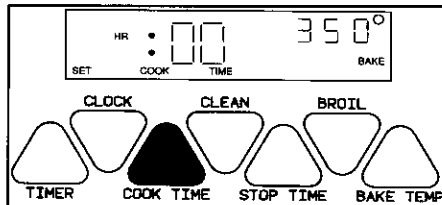
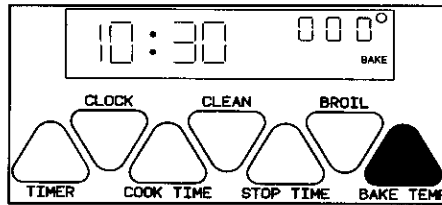

GENERAL INFORMATION

IMPORTANT: Highly perishable foods such as dairy products, pork, poultry, seafoods or stuffing are not recommended for delayed cooking. If cooking more than one food, select foods that cook for the same length of time and at the same oven temperature.

If you delay in entering a complete program, the oven may turn on. Just continue entering the program as described.

To reset or cancel the program: Press the STOP/CLEAR pad.

After setting the Automatic Cooking feature, press the CLOCK pad and the time-of-day will reappear in the display. "TIMED BAKE ON" or "DELAY BAKE" and the oven temperature will remain in the display as a reminder that the oven is set for a cooking operation.

At end of cooking, continuous beeps will sound. Press STOP/CLEAR pad to cancel beeps.

TO BAKE BY TIME with delayed START:

1. Follow steps 1, 2, 3 and 4 above.
2. Press STOP TIME pad. "SET STOP TIME" flashes in the display.
3. Enter the time you wish the oven to turn off by turning the SET knob. "DELAY TIMED BAKE" lights in the display. Time-of-day reappears in the display.
The oven will automatically turn on in time to have the food cooked by the preselected STOP TIME. The oven will automatically turn off at the preset stop time.
4. Press STOP/CLEAR pad to cancel end-of-cooking beeps.

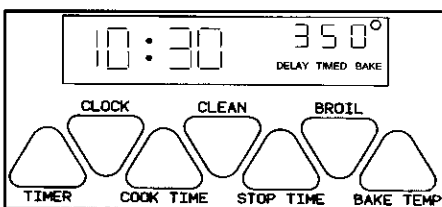
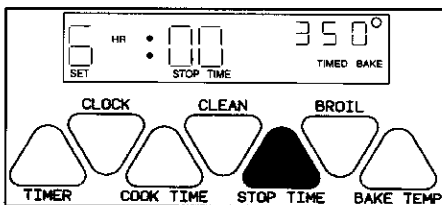

EXAMPLE

Food is to cook for 2 hours and 30 minutes at 350°F. You wish the food to be cooked by 6:00.

1. Press BAKE TEMP pad.
2. Turn SET knob until 350° appears in the display.
3. Press COOK TIME pad.
4. Turn SET knob until 2:30 (2 hours, 30 minutes) appears in the display.
5. Press STOP TIME pad.
6. Turn SET knob until 6:00 appears in the display.

The oven will turn on at 3:30; cook the food for 2 1/2 hours, and will automatically turn off at 6:00.

USING YOUR SMOOTHTOP

COOKING AREAS

The four surface cooking areas on your range are identified by permanent patterns in the cooktop. There are two large and two small areas. Use the smaller areas for small cooking utensils and the larger areas for large utensils. This conserves energy.

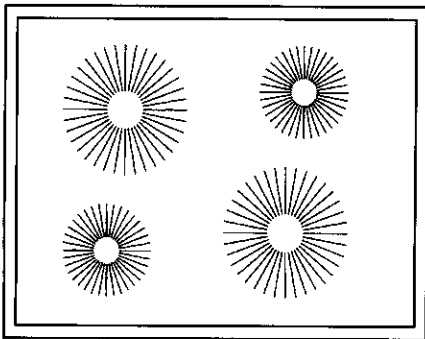

When a cooking area is turned ON, the coil element under the cooktop will heat up and glow red. The element will cycle on and off to maintain the heat setting. When the element cycles on, it is normal to see a red glow through the smoothtop.

SURFACE CONTROLS

The cooking area controls are called INFINITE controls. This type of control provides an infinite choice of heat settings from LOW to HIGH. The control can be set either on any of the numbered settings or between the numbered settings.

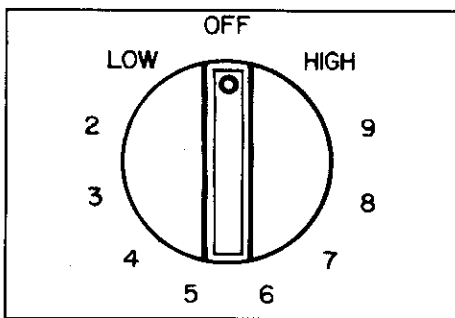

Knobs on your range may not look like this knob but they operate as described in this booklet.

To operate: Push in and turn knob, in either direction, to the desired heat setting.

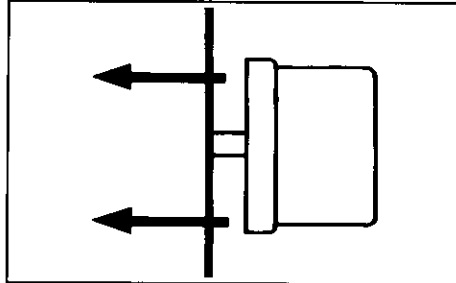

SIGNAL LIGHTS

Ranges are equipped with one to four signal lights to indicate when a surface element is on. The light will remain on until the element is turned off. After a cooking operation, be sure element and signal light are off.

HOT SURFACE LIGHT

The range is equipped with a HOT SURFACE light. This red light will turn on to indicate that the cooking area is hot and will remain on until the area has cooled.

RETAINED HEAT

We suggest that you start with a lower heat setting then gradually increase the setting until you find the optimum setting. Boilovers are more likely to occur if you start out on HIGH then reduce to the lower setting.

The smoothtop cooking area retains heat for a period of time after the element has been turned off. Put this residual heat to good use. Turn the element off a few minutes before food is completely cooked and use the retained heat to complete the cooking operation. After 30 minutes, the cooktop may be too cool to keep foods warm; however, the TOP MAY STILL BE TOO WARM TO TOUCH. When the HOT SURFACE indicator light turns off, the top will be cool enough to touch.

HINTS

If food is cooking too fast or if boilovers occur, remove lid and reduce to a lower setting. Allow enough time for the cooking area to adjust to the new setting.

To help keep cooktop clean be sure cooking area and utensil bottom are clean and dry before use.

Do not allow plastic objects, aluminum foil, sugar, or foods with high sugar content to melt onto the hot cooktop. Melted materials can cause permanent damage to the cooktop.

IMPORTANT: Watch sugary solutions carefully to avoid boilover. If sugar solution (such as jam, jelly, candy) is allowed to boilover, it may pit the glass. Turn element to LOW and clean sugary boilovers **immediately**. Use a wooden-handled metal spatula to scrape boilover to a cooler area of the cooktop or use several layers of dry paper towels to wipe up spillover. If a paper towel is used, be careful to avoid steam burns. Turn element off. When cool, use a single-edge razor blade such as Widget by Gillette to scrape off soil. Clean with Elco Cooktop Cleaning Creme, rinse and dry.

To protect the top, it is not recommended to use the top as a work surface or as a cutting board or to cook food directly on the cooktop without a utensil.

Do not use a trivet or metal stand (such as a wok ring) between the utensil and the cooktop. These items can mark or etch the surface and affect cooking efficiency.

Thin gauge aluminum cookware, aluminum foil or foil containers such as popcorn poppers are NOT recommended for use on the cooktop. They will leave metal marks.

Do not slide glass items across the cooktop. They may scratch or damage the top.

Do NOT slide aluminum cookware across the cooktop. This may result in aluminum marks which then must be immediately removed with a recommended cooktop cleaner.

USING YOUR SMOOTHTOP

COOKWARE

Cooking performance is greatly affected by the type of cookware used. Pans should have a flat bottom. The flat bottom allows good conductivity between the utensil and the cooking area to provide uniform cooking results, faster heating and more efficient use of energy.

Pans with uneven, warped, or grooved bottoms do not make good contact, reduce heat conductivity and result in slower, less even heating.

Be sure utensil is large enough to properly contain food and avoid boilovers.

Pan size is particularly important in deep frying. Be sure pan will accommodate the volume of food that is to be added as well as the bubble action of fat. **Never leave a deep fat frying operation unattended.**

Acceptable water-bath or pressure canners should not be oversized and must have a flat bottom.

Do not use specialty items that are oversized, have an uneven bottom or do not meet proper utensil specifications.

SPECIAL PRECAUTIONS FOR COOKING UTENSILS:

- **Aluminum foil** will damage the smoothtop if it melts onto the glass. Do not use aluminum foil or foil-type containers under any circumstances.
- **Aluminum utensils** will cause metal marks on the glass if you slide them across the ceramic cooktop. Remove any metal marks immediately.
- **Glass ceramic, earthenware, heat-proof glass or glazed utensils** may scratch the smoothtop cooktop if you slide them across the top.

SUGGESTED HEAT SETTINGS

Use the following chart as a GUIDELINE until you become more familiar with your cooktop. Keep in mind that different types of cookware materials require different heat settings for the same cooking operation. We suggest that you experiment to find the heat setting that best suits your particular cooking needs. Information in the chart is based on heavy gauge aluminum cookware. Lower the heat setting if using stainless steel, cast iron utensils or glassware designed for surface cooking.

HEAT SETTINGS	USES
HI	To bring liquid to a boil, blanch, preheat skillet, or bring pressure up in pressure cooker. (Note: Always follow instructions in pressure cooker use and care book.) Always reduce to a lower heat setting when liquids just begin to boil or food begins to cook.
Medium-High 9 8 7	To brown or sear meat, heat oil for deep fat frying, scald. To fast saute or fry. Maintain fast boil for large amounts of liquids. For slower frying or sauteing operation.
Medium 6-5	To maintain moderate to slow boil for large amounts of liquids.
Medium-Low 4 3 2	To continue cooking uncovered foods and for most frying operations. To continue cooking covered foods and to maintain boil pressure in most pressure cookers. Stew, braise or steam operations. To maintain boil for small amounts of liquid, poach, steam or simmer.
LO	To keep foods warm before serving.

NOTE: Refer to cookware manufacturer's recommendations for suggested heat settings. Some manufacturers do not recommend the use of HIGH or the use of HIGH for extended cooking operations.

USING YOUR SMOOTHTOP

CARE INFORMATION

Clean smoothtop after each use. Use only cleaning agents recommended in the cleaning chart. Other materials may damage the finish of the smoothtop.

Carefully blot up spillovers around the outside of the cooking area as they occur with dry paper towels. **BE CAREFUL NOT TO BURN HANDS WHEN WIPING UP SPILLS. DO NOT USE A DAMP CLOTH WHICH MAY CAUSE STEAM BURNS.**

When surface is cool, clean as directed in the chart. **DO NOT USE** the following cleaning agents.

- Abrasives (metal scouring pads, cleansing powders, scouring cleaners or pads) will scratch the smoothtop.
- Chemicals (oven cleaners, chlorine bleaches, rust removers or ammonia) may damage the finish of the smoothtop.
- Cleaning agents designed for glassware which contain ammonia may harm the smoothtop.
- Soiled cloth or sponge will leave an invisible film on the cooktop which may cause discoloration the next time the cooktop is used.

CAUTION:

If metal melts onto the smoothtop, **DO NOT USE TOP. CALL AN AUTHORIZED SERVICER.** Do not attempt to repair cooktop yourself.

To prevent permanent damage to the cooktop, do not allow cookware to boil dry.

Do not place plastics on a warm or hot cooking area. They will melt and adhere to the smoothtop. The smoothtop may chip or pit in attempting to remove melted plastic from the top.

To prevent scratching or damage to the smoothtop: Do not leave sugar, salt, sand, soil, shortening or other fats on the cooking area. Be sure area is free from these before turning on cooking area.

CLEANING CHART

WARNING: BEFORE CLEANING, BE CERTAIN ALL ELEMENTS ARE TURNED OFF AND THE COOKTOP IS COOL.

Daily cleaning, light to moderate stains.	Elco Cooktop Cleaning Creme. Liquid dishwashing detergent. Paste of baking soda and water.	Gently apply with a non abrasive plastic brush, nylon or plastic pad, or paper toweling, rinse completely and dry.
Heavy stains, burned on food.	Elco Cooktop Cleaning Creme. Paste of baking soda or and water.	Gently scour with paste and paper towel to remove as much as possible. Then re-apply paste and let stand for 30 to 45 minutes. Cover with damp paper toweling to keep paste moist. Scour to remove remaining stain. Rinse completely and dry.
Burned on or crusty soil.	Single-edge razor blade such as Widget by Gillette.	When cooktop is cool: Place edge of single edge razor on ceramic cooktop at a 30° angle. Very CAREFULLY scrap off soil. Clean remaining soil with Elco Cooktop Cleaning Creme.
Brown or gray stains from HARD WATER or metal marks.	Elco Cooktop Cleaning Creme.	Gently scour with paste to remove as much as possible. Reapply paste and let stand for 30 minutes. Scour with additional paste to remove remaining stain. Rinse completely and dry.

PROBLEM SOLVING CHART

PROBLEM	CAUSE	TO PREVENT
Tiny scratches or abrasions	Coarse particles (dust salt and sand) between cookware bottom and cooktop. Incorrect cleaning materials. Sliding glassware or metal across top or using cookware with rough bottoms.	Tiny scratches are not removable and do not affect cooking. In time, the scratches will become smoother and less visible. Be sure cookware bottoms and cooktop are clean before use. Use cookware with a smooth, non-scratching bottom. Do not slide cookware across cooktop.
Metal-marking	Sliding or scraping metal utensils or oven racks across cooktop.	Do not slide any glass or metal object across cooktop. Clean immediately with Elco Cooktop Cleaning Creme.
Brown streaks and specks	Boilovers, incorrect cleaning materials, used soiled cloth or sponge, soiled cookware.	Remove boilovers before reusing the cooktop. Use a clean cloth or sponge. Be sure cookware, especially bottoms, are clean and dry.
Areas of discoloration with a metallic sheen	Mineral deposits from water and foods.	Use cookware with bottoms that are clean and dry. Use correct heat setting to prevent boilovers.
Pitting or flaking.	Sugary boilovers from sugar syrups, candy, jams, jellies, dessert sauces, etc.	Use correct heat setting and large enough utensil. Watch cooking operation to prevent boilovers or spattering. See "HINTS" on page 7 for cleaning instructions.

USING YOUR OVEN

OVEN CHARACTERISTICS

Every oven has its own characteristics. You may find that the cooking times and temperatures you were accustomed to with your previous range may need to be altered slightly with your new range. Please expect some differences with this new range.

IMPORTANT

DO NOT MOVE DOOR LOCK LEVER TO THE RIGHT DURING A COOKING OPERATION. If the door lock lever is moved to the lock position, the cooking operation will automatically be cancelled and "door" will appear in the display.

FAN

Slide in and drop in models are equipped with a fan which automatically turns on whenever the oven is set for cooking or cleaning. The fan will automatically turn off when the unit has cooled.

OVEN RACKS

The two oven racks are designed with a "lock-stop" position to keep racks from accidentally coming completely out of the oven.

To remove: Be sure rack is cool. Pull rack out to the "lock-stop" position. Tilt up and continue pulling until rack releases.

To replace: Place rack on rack supports, tilt up and push toward rear of oven. Pull rack out to "lock-stop" position to be sure rack is correctly replaced.

RACK POSITIONS:

RACK 1 (top of oven) used for broiling thin non-fatty foods such as fish.

RACK 2 used for two-rack baking or broiling thicker cuts of meat.

RACK 3 used for most one-rack baking and for roasting some meats.

RACK 4 used for one or two rack baking and roasting large meats, cooking larger foods and for baking angel food cake or pie shells.

RACK 5 used for roasting turkey or baking angel food cake or pie shells.

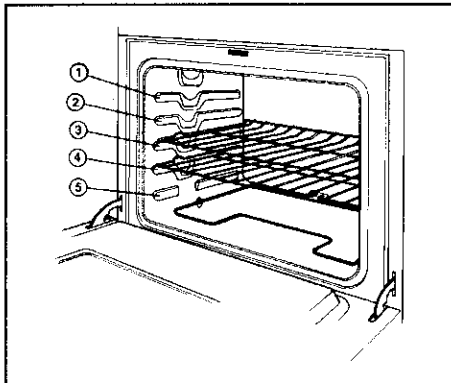

HINTS:

If cooking on two racks, stagger pans so one is not directly over the other. Use rack positions 2 and 4 or 2 and 5, when cooking on two racks.

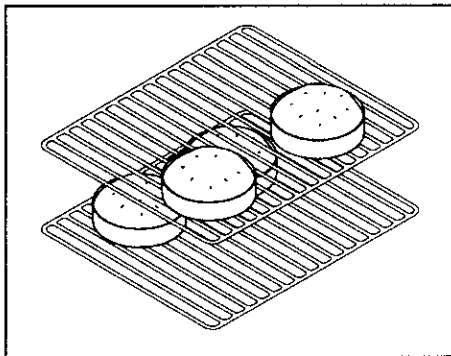

For optimum baking results of cakes, cookies or biscuits, use one rack. Position rack so food is in the center of the oven. Allow 2 inches between edge of utensil and the oven sides or adjacent utensils.

NEVER place pans directly on the oven bottom.

Do not cover entire rack with aluminum foil or place foil directly under cookware. To catch spillovers, cut a piece of foil a little larger than the pan and place it on the rack below the rack containing the pan.

PREHEATING

Preheating is necessary for baking. Allow oven to heat for 10 to 15 minutes before adding food.

It is not necessary to preheat oven for roasting. It is not necessary to preheat for broiling unless darker browning is desired or if cooking thin (3/4-inch) steaks. Allow broil element to preheat 3 to 5 minutes.

Selecting temperature higher than desired will NOT preheat the oven any faster. Preheating at a higher temperature may have a negative effect on baking results.

To preheat: Set oven for baking and allow the oven to heat until display shows the preset temperature. 100 will appear in the display until the oven reaches 100°F. The display will then show the oven temperature in 5° increments until the oven reaches the preset temperature.

Once the preset temperature is reached, and the oven temperature has stabilized, a single beep will sound.

If the oven temperature is changed after preheating, a beep will signal that the oven has reached the new temperature setting.

USING YOUR OVEN

TO SET OVEN:

1. Press **BAKE TEMP** pad. **BAKE** indicator turns on.
2. Turn **SET** knob until desired temperature is displayed.
3. **BAKE ON** indicator and oven immediately turn on.
4. Place food in oven when oven has preheated to set temperature.
5. Check food at minimum time. Cook longer if necessary.
6. Press **STOP/CLEAR** pad to cancel the operation.

Preheat oven for all baking operations.

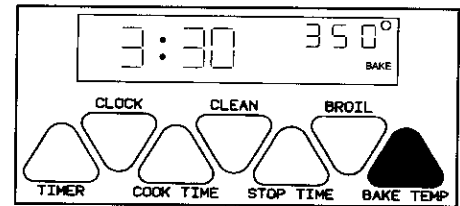

COMMON BAKING PROBLEMS AND WHY THEY HAPPEN

PROBLEM	CAUSE	PROBLEM	CAUSE
<i>Cakes are uneven.</i>	Pans touching each other or oven walls. Batter uneven in pans. Temperature set too low or baking time too short. Oven not level. Undermixing. Too much liquid.	<i>Cakes don't brown on top.</i>	Incorrect rack position. Temperature set too low. Overmixing. Too much liquid. Pan size too large or too little batter in pan. Oven door opened too often.
<i>Cake high in middle.</i>	Temperature set too high. Baking time too long. Overmixing. Too much flour. Pans touching each other or oven walls. Incorrect rack position.	<i>Excessive shrinkage.</i>	Too little leavening. Overmixing. Pan too large. Temperature set too high. Baking time too long. Pans too close to each other or oven walls.
<i>Cake falls.</i>	Too much shortening or sugar. Too much or too little liquid. Temperature set too low. Old or too little baking powder. Pan too small. Oven door opened frequently. Added incorrect type of oil to cake mix. Added additional ingredients to cake mix or recipe.	<i>Uneven texture.</i>	Too much liquid. Undermixing. Temperature set too low. Baking time too short.
<i>Cakes, cookies, biscuits don't brown evenly.</i>	Incorrect rack position. Oven door not closed properly. Door gasket not sealing properly. Incorrect use of aluminum foil. Oven not preheated. Pans darkened, dented or warped.	<i>Cakes have tunnels.</i>	Not enough shortening. Too much baking powder. Overmixing or at too high a speed. Temperature set too high.
		<i>Cakes crack on top.</i>	Batter overmixed. Temperature set too high. Too much leavening. Incorrect rack position.
		<i>Cake not done in middle.</i>	Temperature set too high. Pan too small. Baking time too short.
<div style="border: 1px solid black; padding: 5px;"> For optimum results, bake on one rack. If baking cakes on two racks, place pans toward front of oven on upper rack and pans toward back of oven on lower rack. </div>		<div style="border: 1px solid black; padding: 5px;"> If additional ingredients were added to mix or recipe, expect cooking time to increase. </div>	
<i>Cakes, cookies, biscuits too brown on bottom.</i>	Oven not preheated. Pans touching each other or oven walls. Incorrect rack position. Incorrect use of aluminum foil. Placed 2 cookie sheets on one rack. Used glass, darkened, stained, warped or dull finish metal pans. (Use a shiny cookie sheet.)	<i>Pie crust edges too brown.</i>	Temperature set too high. Pans touching each other or oven walls. Edges of crust too thin.
<div style="border: 1px solid black; padding: 5px;"> Follow utensil manufacturer's instructions for oven temperature. Glassware and dark utensils such as Ecko's Baker's Secret require lowering the oven temperature by 25° F. </div>		<i>Pies don't brown on bottom.</i>	Used shiny metal pans. Temperature set too low.
		<i>Pies have soaked crust.</i>	Temperature too low at start of baking. Filling too juicy. Used shiny metal pans.

USING YOUR OVEN

HOW TO BROIL

Broiling is a method of cooking tender meats by direct heat under the element. The cooking time is determined by the distance between the meat and the element, the desired degree of doneness and the thickness of the meat.

Broiling requires the use of the broiler pan and insert. The correct position of the insert in the pan is very important. The broiler insert should be placed in the pan so grease will drain freely. Improper use may cause grease fires.

The broiler insert CANNOT be covered with aluminum foil as this prevents fat from draining into pan below. However, for easier cleaning, the broiler pan can be lined with foil.

Do not use disposable broiler pans. They do not provide a separate tray. Preheat broil element 5 to 10 minutes if

darker browning is desired.

TO BROIL:

1. Prepare meat by removing excess fat and slashing remaining fat, being careful not to cut into meat. This will help keep meat from curling.
2. Place broiler pan on any of the recommended rack positions. Generally, for brown exterior and rare interior, the meat should be close to the element. Place further down if you want meat well done.
3. Broiling should be done with oven door opened to the broil stop position (opened about 4-inches).
4. Follow suggested times on broiling chart. Meat should be turned once about half way through cooking.
5. Check doneness by cutting a slit in meat near center for desired color.
6. Press STOP/CLEAR pad to cancel a broil operation.

To set oven:

- Press BROIL pad. "Broil" lights in the display.
- Turn SET knob clockwise to select HI for normal broiling. Turn SET knob counter clockwise to select LO for special low temperature broiling.
- "ON" lights in the display. The oven immediately turns on and begins to heat.

Use HI BROIL for most broil operations. When broiling longer cooking foods such as pork chops, poultry or thick steaks, select LO BROIL. Low temperature broiling allows food to cook to the well done stage without excessive browning. Cooking time may increase if LO BROIL is selected. Broil times may need to be increased if range is installed on a 208-volt circuit.

BROILING CHART

TYPE OF FOOD	RACK POSITION	DONENESS	TOTAL TIME
BACON	#2	Well Done	6 to 10 minutes
BEEF STEAKS 1-inch thick	#2	Rare	10 to 14 minutes
	#2	Medium	15 to 18 minutes
	#2	Well Done	19 to 22 minutes
1 1/2-inch thick	#2	Rare	18 to 20 minutes
	#2	Medium	22 to 24 minutes
	#3	Well Done	25 to 30 minutes
CHICKEN Whole, split Pieces	#3 #3	Well Done Well Done	LO BROIL 45 to 60 minutes 30 to 45 minutes
FISH STEAK OR FILLET 1/2-inch thick	#2	Flaky	10 to 12 minutes
GROUND BEEF PATTIES 3/4 to 1-inch thick	#2	Rare Medium Well Done	10 to 13 minutes 12 to 15 minutes 15 to 18 minutes
HAM SLICE , precooked 1-inch thick 1 1/2-inch thick	#2 #2		12 to 16 minutes 21 to 26 minutes
LAMB CHOPS 1-inch thick	#2	Medium Well Done	12 to 15 minutes 16 to 20 minutes
1 1/2-inch thick	#3	Medium Well Done	15 to 19 minutes 25 to 30 minutes
PORK CHOPS 3/4-inch thick 1-inch thick	#2 #2	Well Done Well Done	15 to 20 minutes 20 to 25 minutes
WIENERS , precooked Hot dogs, smoked or Polish sausage, Bratwurst, etc.	#2		8 to 12 minutes
BREADS Toast Toaster Pastries English Muffins, buttered	#2 #2 #2		TIME PER SIDE 5 to 8 minutes/side 5 to 8 minutes/side 5 minutes

MAINTENANCE

LIGHT REPLACEMENT

Before replacing light bulb, DISCONNECT POWER TO RANGE.

To replace fluorescent surface light: Grasp the top trim of backguard with thumbs under front edge and pull outward while lifting to release trim from catches at each end.

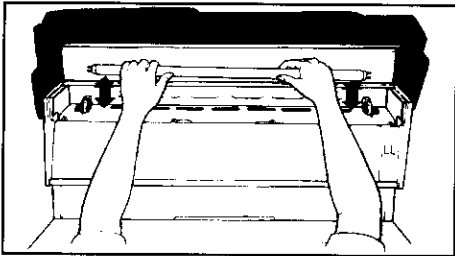

Remove bulb and replace with an 18 watt fluorescent tube. Snap top trim back into place, restore power and reset clock.

To replace oven light: Be sure bulb is cool. Do not touch a hot bulb with a damp cloth as the bulb may break. Use a dry potholder, to prevent possible harm to hands, and very carefully unscrew bulb cover and bulb.

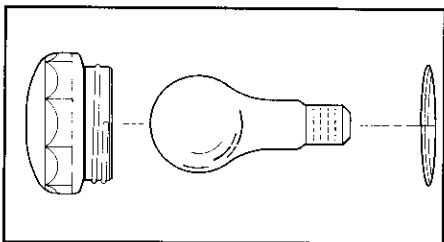

Replace with a 40 watt appliance bulb. Replace bulb cover and reconnect power to range. Reset clock.

STORAGE DRAWER

The storage drawer at the bottom of the range is safe and convenient for storing metal and glass cookware. DO NOT store plastic, paperware, food or flammable material in this drawer. Remove drawer to clean under range.

To remove: Empty drawer then pull drawer out to the first stop position. Lift up front of drawer and pull to the second stop position. Grasp sides and lift up and out to remove drawer.

To replace: Fit ends of drawer slides onto rails. Lift up drawer front and gently push in to first stop position. Lift up drawer again and continue to slide drawer to the closed position.

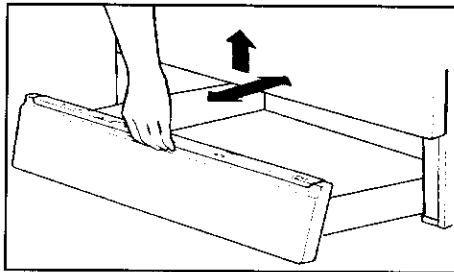

OVEN DOOR

Do not place excessive weight on an open oven door or stand on an open oven door as, in some cases, it could cause the range to tip over, breakage of the door or serious injury.

When opening oven door, allow steam and hot air to escape before reaching in oven to check, add or remove food.

To remove lift-off door: Open door to the "stop" position (opened about 4 inches) and grasp door with both hands at each side. Do not use door handle to lift door. Lift up evenly until door clears the hinge arms.

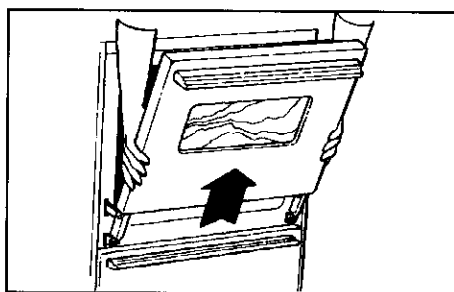

CAUTION:

Hinge arms are spring mounted and will slam shut against the range if accidentally hit. **Never place hand or fingers between the hinges and the front oven frame.** You could be injured if hinge snaps back.

To replace door: Grasp door at each side, align slots in the door with the hinge arms and slide door down onto the hinge arms until completely seated on hinges.

Do not attempt to open or close door until door is completely seated on hinge arms. Never turn on oven unless door is properly in place. When baking, be sure door is completely closed. Baking results will be affected if door is not securely closed.

LEVELING LEGS

Some floors are not level. For proper baking, your range must be level. Leveling legs are located on each corner of the base of the range. Level by turning the legs.

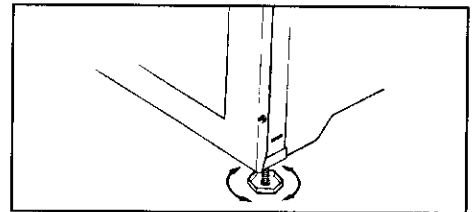

To prevent range from accidentally tipping, range should be secured to the floor by sliding rear leveling leg into the anti-tip bracket supplied with the range.

FUSES

(CANADIAN RANGES ONLY)

Your range is equipped with seven (7) type "P" fuses. The fuses are located on the back wall. Remove the storage drawer for access to the fuses.

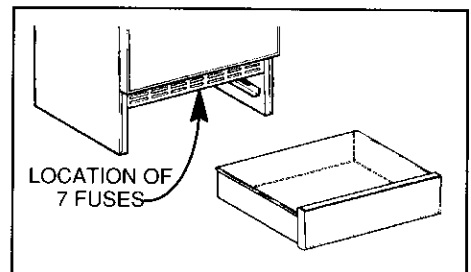

If part of your range does not operate, check to see if a fuse has blown. A gap in the fuse strip or a darkened window indicates a blown fuse. Replace with the same type and amperage type "P" fuse.

CARE AND CLEANING

PARTS	CLEANING AGENTS	DIRECTIONS Be sure all parts are cool before cleaning. Be sure all parts are properly replaced after cleaning.
Broiler pan & insert	Soap & water. Plastic scouring pad. Soap filled scouring pad.	Remove from oven after use. Cool then pour off grease. Place soapy cloth over insert and pan; let soak to loosen soil. Wash in warm soapy water. Use soap filled scouring pad to remove stubborn soil. Clean in dishwasher if desired.
Baked Enamel: Side panels Backguard Oven door Storage drawer	Soap & water. Paste of baking soda & water.	Use a dry paper towel or cloth to wipe up spills, especially acid spills, as soon as they occur. (This is especially important for white surfaces.) When surface is cool, wash with soap and water. Do not use abrasive or harsh cleaning liquids and powders or oven cleaners. These will scratch and permanently damage the finish. Dry with a soft cloth.
Control knobs	Mild detergent & water.	To remove knobs, gently pull forward. Wash in mild detergent and water. Do not use abrasive cleaning agents. They will scratch finish and remove markings. Rinse, dry and replace. Turn each element ON to see if knobs have been replaced correctly.
Glass: Backguard Oven window See page 9 for smoothtop instructions	Soap & water. Paste of baking soda & water. Window cleaning fluid.	Wash with soap and water. Remove stubborn soil with paste of baking soda and water. Do not use abrasive materials such as scouring pads, steel wool or powdered cleaning agents. They will damage glass. Rinse with clear water and dry. To prevent staining of oven window, never use excessive amounts of water which may seep under or behind glass.
Metal finishes: Aluminum – backguard base. Chrome & stainless steel – trim parts	Soap & water. Paste of baking soda & water.	Wash with soap and water. Remove stubborn soil with paste of baking soda and water. Do not use oven cleaners, abrasive or caustic agents. They will damage the finish.
Oven Elements		Elements are self-cleaning. Soil will burn off as elements are used. Do not spray oven cleaner on elements, electrical hook up or connection.
Oven racks	Soap & water. Cleansing powders & plastic pads. Soap filled scouring pad.	Clean with soapy water. Remove stubborn soil with cleansing powder or soap filled scouring pad. Rinse and dry.
Plastic finishes: Door handle, Trim, Backguard trim, Overlay, Knobs, or End caps	Soap & water. Paste of baking soda and water. Non-abrasive plastic pad or sponge.	Do not use oven cleaner, powder or liquid cleansers, abrasive or caustic cleaning agents on plastic finishes. These cleaning agents will scratch or mar finish. To prevent staining or discoloration, wipe up fat, grease or acid (tomato, lemon, vinegar milk, fruit juice, marinade) immediately with a dry paper towel or cloth. When surface is cool, clean with soap and water; rinse, and dry.
Porcelain enamel: Cooktop See page 5 for self-clean oven.	Mild liquid cleaners, detergent or soap & water. Cleansing powders and non abrasive nylon or plastic pads.	Porcelain enamel is glass fused on metal. It may crack or chip with misuse. Clean with soap and water when parts are cool. All spillovers, especially acid or sugar spillovers, should be wiped up immediately with a dry cloth. Surface may discolor or dull if soil is not removed. When surface is cool, clean with warm soapy water. NEVER WIPE OFF A WARM OR HOT ENAMEL SURFACE WITH A DAMP CLOTH. THIS MAY CAUSE CRACKING AND CHIPPING. Never use oven cleaners, abrasive or caustic cleaning agents on exterior finish of range. NOTE: The cooktop does NOT lift up.

SERVICE

PART OR ALL OF YOUR RANGE DOES NOT OPERATE	Is the range plug disconnected from the electrical outlet? • Are house fuses blown or circuit breakers tripped? • Is the range plug loose or improperly plugged in? Has power supply to your home been interrupted? • Was oven properly set?
F PLUS A NUMBER APPEARS IN THE DISPLAY AND A CONTINUOUS BEEP SOUNDS. (EXAMPLE: F 2)	This is called a FAULT CODE. If a fault code appears in the display, press the STOP/CLEAR pad. If the fault code reappears, disconnect power to the range and call the servicer.
CONTROL WILL NOT ACCEPT AN ENTRY	This may indicate a "stuck" pad. Press each of the seven pads to disengage the pad. Then, press STOP/CLEAR pad and reprogram the operation. If the control still does not accept an entry after checking each pad, call the servicer.
SURFACE ELEMENTS FAIL TO TURN ON OR HEAT FOOD PROPERLY	Is range plug disconnected from the electrical outlet? • Check circuit breaker or fuse box for tripped circuit breakers or blown fuses. • Is element properly plugged into receptacle? • Was incorrect utensil used? • For optimum results, utensil SHOULD HAVE A FLAT bottom. See page 8 for additional information. (NOTE: Expect cooking times to increase if range is connected to 208 volts). • Have serviceman check element.
FOOD NOT BAKING SATISFACTORILY	Are racks properly in place and in correct position for what you are baking? • Is range level? • Are you using the proper pan? • Is it bright, not soiled or dark colored? • Have you used foil incorrectly? • Are you using standard measuring utensils? • Did you preheat if recommended? • Oven temperature is incorrectly set – too low or too high.
OVEN DOES NOT OPERATE	Is the range disconnected from the electrical power? • Was oven properly set?
OVEN LIGHT DOES NOT WORK	Is bulb loose or burned out?

SERVICE

Do not attempt to service the appliance yourself unless directed to do so in this book. Contact the dealer who sold you the appliance for service.

HOW TO OBTAIN SERVICE

When your appliance requires service or replacement parts, contact your Dealer or Authorized Servicer. Use only genuine factory or Maycor parts if replacement parts are necessary. Consult the Yellow Pages in your telephone directory under appliance for the service center nearest you. Be sure to include your name, address, and phone number, along with the model and serial numbers of the appliance. (See front

cover for location of your model and serial numbers.)

If you are unable to obtain service, write to us. Our address is found on the rating plate. See front cover for location of rating plate.

If you are not satisfied with the local response to your service requirements, call or write MAYCOR Appliance Parts and Service Company, 240 Edwards Street, S.E., Cleveland, TN 37311, (615) 472-3500. Include or have available the complete model and serial numbers of the appliance, the name and address of the dealer from whom you purchased the appliance, the date of purchase and details concerning your problem.

If you did not receive satisfactory service through your servicer or Maycor you may contact the Major Appliance Consumer Action Panel by letter including your name, address, and telephone number, as well as the model and serial numbers of the appliance.

Major Appliance Consumer Action Panel
20 North Wacker Drive
Chicago, IL 60606

MACAP (Major Appliance Consumer Action Panel) is an independent agency sponsored by three trade associations as a court of appeals on consumer complaints which have not been resolved satisfactorily within a reasonable period of time.

FULL ONE-YEAR WARRANTY

DOMESTIC GAS OR ELECTRIC RANGE

Maycor Appliance Parts & Service Company will repair or replace, without charge, any part of your product which has a defect in material or workmanship during the first year after the date of the original installation. This warranty extends to any owner during the one-year warranty period.

LIMITED 5 YEAR WARRANTY

On electric ranges equipped with solid disc or smoothtop heating elements, and on gas ranges with sealed burners, for an additional 4 year period beyond the first year of the general coverage of this warranty, Maycor will replace any of the solid disc or smoothtop heating elements, or sealed burners which fail to heat as a result of defective workmanship or material. Additionally, Maycor will replace any smoothtop cooking surface which cracks or breaks during normal household cooking. These parts must be installed by a qualified person. Any labor charge required for replacement is not covered by this warranty.

HOW TO OBTAIN SERVICE

To obtain the repair or replacement of a defective part under these warranties, you should contact the dealer from whom you purchased the appliance or a servicer he designates.

WHAT IS NOT COVERED BY THESE WARRANTIES

1. Conditions and damage resulting from improper installation, delivery, unauthorized repair, modification, or damage not attributable to a defect in material or workmanship.
2. Conditions resulting from damage, such as: (1) improper maintenance, (b) misuse, abuse, accident, or (c) incorrect electrical current or voltage.
3. Warranties are void if the original serial number has been removed, altered, or cannot be readily determined.
4. Light bulbs.
5. Any product used for other than normal household use. It does not extend to products purchased for commercial or industrial use.
6. Any expense incurred for service calls to correct installation errors or to instruct you on how to use the products.
7. CONSEQUENTIAL OR INCIDENTAL DAMAGES SUSTAINED BY ANY PERSON AS A RESULT OF ANY BREACH OF THESE WARRANTIES OR ANY IMPLIED WARRANTY. Some states do not allow the exclusion or limitation of consequential or incidental damages, so the above exclusion may not apply to you.

ADDITIONAL HELP

If you are not satisfied with the local response to your service requirements and wish to contact Maycor, please address your letter to the Customer Relations Department, Maycor Parts & Service Company, 240 Edwards Street, S.E., Cleveland, TN 37311 or call (615) 472-3500. To save time, your letter should include the complete model and serial numbers of the warranted appliance, the name and address of the dealer from whom you purchased the appliance, the date of purchase and details concerning your problem.

These warranties are the only written or expressed warranties given by Maycor. No one is authorized to increase, alter, or enlarge Maycor's responsibilities or obligations under these warranties. These warranties give you specific legal rights, and you may also have other rights which vary from state to state.

8109P059-60
(6/91)