

Owner's Guide

READ AND KEEP THESE INSTRUCTIONS FOR FUTURE REFERENCE.

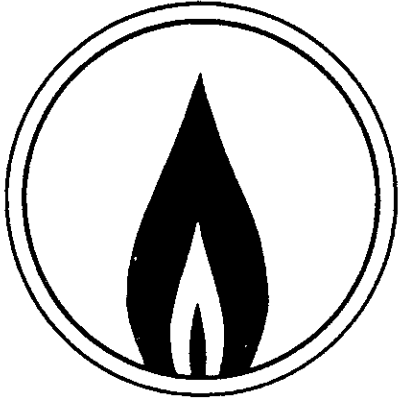

Gas Range Featuring

- Conventional Surface Burners
- Pilot Ignition
- or
- Pilotless Ignition
- Time-of-Day Clock, if equipped

CONTENTS

IMPORTANT SAFETY INSTRUCTIONS	1-3	MAINTENANCE	13-15
CLOCK AND TIMER	4-5	Cooktop	13
Analog clock and timer	4	Burner grates	13
Digital clock and timer	4	Surface burners	13
Electronic clock and timer	5	Oven door	14
SURFACE COOKING	6-7	Oven racks	14
Ignition system	6	Oven bottom	14
• Pilot ignition		Broiler drawer	14
• Pilotless ignition		Oven light	15
To light surface burner	6	Leveling legs	15
About the surface burner flame	6	How to remove range for cleaning	15
Additional information	6	Proportional valve adjustment	15
Factors that determine flame size	7	GENERAL INFORMATION	16
Selecting flame size	7	Electrical connection	
Canning	7	Use of aluminum foil	
USING YOUR OVEN	8-12	CARE AND CLEANING	17-19
Oven characteristics	8	Cleaning chart	17-18
Ignition system	8	Continuous cleaning oven	19
• Pilot ignition		SERVICE	20-21
• Pilotless ignition		Before calling service chart	20
Oven vent	8	How to obtain service	21
Oven burner	8	WARRANTY	22
Oven thermostat	8		
To set oven	9		
Preheating	9		
Rack positions	9		
General baking tips	10		
Common baking problems	11		
How to broil	12		

FOR FUTURE REFERENCE

For future reference we suggest you retain this manual after recording the model number and serial number of this gas appliance in the spaces provided. This information can be found on the rating plate located on the sides of the lower range front frame. Pull out lower drawer to see rating plate.

MODEL NUMBER

SERIAL NUMBER

DATE OF PURCHASE

These numbers identify your range. Please use them in any correspondence or service calls concerning your appliance.

Please retain the proof of purchase documents for warranty service.

WARNING: If the information in this manual is not followed exactly, a fire or explosion may result causing property damage, personal injury or death.

- Do not store or use gasoline or other flammable vapors and liquids in the vicinity of this or any other appliance.
- WHAT TO DO IF YOU SMELL GAS:
 - Do not try to light any appliance.
 - Do not touch any electrical switch; do not use any phone in your building.
 - Immediately call your gas supplier from a neighbor's phone. Follow the gas supplier's instructions.
 - If you cannot reach your gas supplier, call the fire department.
- Installation and service must be performed by a qualified installer, service agency or the gas supplier.



WARNING

- ALL RANGES CAN TIP
- INJURY TO PERSONS COULD RESULT
- INSTALL ANTI-TIP DEVICES PACKED WITH RANGE
- SEE INSTALLATION INSTRUCTIONS

To reduce the risk of tipping of the appliance from unusual usage or by excessive loading of the oven door, the appliance must be secured by a properly installed anti-tip device. To check if device is installed properly: Use a flashlight and look underneath range to see that one of the rear leveling legs is engaged in the bracket slot.

IMPORTANT SAFETY INSTRUCTIONS

Read all instructions before using this appliance.

Information in the Safety Instruction section covers all gas cooking appliances. You may find some information that does not pertain to your particular appliance. Please review this section before using your cooking appliance.

GENERAL SAFETY

CAUTION: Some cabinets and building materials are not designed to withstand the heat produced by the normal, safe operation of a cooking appliance. Discoloration or damage, such as delamination, may occur. Therefore, care should be given to the location of this appliance.

- Be sure all packing materials are removed from the range before operating it to prevent fire or smoke damage should the packing material ignite.
- Have your appliance installed and properly grounded by a qualified installer, in accordance with the Installation Instructions. Any adjustment or service should be performed only by a qualified installer or servicer.
- Have the installer show you the location of the gas shut off valve and how to shut it off in an emergency.

No cooking appliance should be used as a space heater to heat or warm a room. This instruction is based on safety considerations to prevent potential hazard to the consumer as well as damage to the appliance.

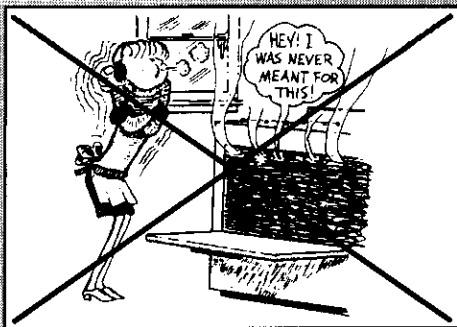

- Don't attempt to repair or replace any part of your appliance unless it is specifically recommended in this book. All other servicing should be referred to a qualified servicer.

- Always disconnect power to appliance before servicing.

- If range is installed near a window, proper precautions should be taken to prevent curtains from blowing over burners creating a FIRE HAZARD.

- Keep area around appliance clear and free from combustible materials, gasoline, and other flammable vapors and materials.

- Many aerosol-type spray cans are EXPLOSIVE when exposed to heat and may be highly flammable. Avoid their use or storage near an appliance.

ABOUT YOUR APPLIANCE

- Your appliance is vented through the base of the backguard. Never block oven vent or air intakes. Do not obstruct the flow of combustion and ventilation air. Restriction of air flow to the burner prevents proper performance.

Avoid touching oven vent area while oven is on and for several minutes after oven is turned off. Some parts of the vent and surrounding area become hot enough to cause burns.

- Do not use cooktop or oven as a storage area for food or cooking utensils. This instruction is based on safety considerations to prevent potential hazard to user and to the appliance.

- Misuse of appliance doors, such as stepping, leaning or sitting on the door, may result in possible tipping of the appliance, breakage of door, and serious injuries.

CAUTION: Do not use an appliance as a step stool to cabinets above.

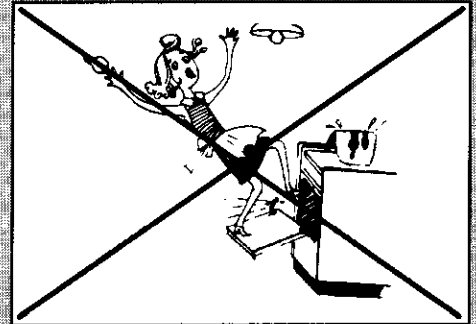

- To reduce the hazard of storage above a range, install a ventilating hood that projects at least 5 inches beyond the bottom edge of the cabinets.

Clean hood frequently to prevent grease from accumulating on hood or its filter.

Should a boilover or spillover result in an open flame, immediately turn off the hood's fan to avoid spreading the flame. After thoroughly extinguishing flame, the fan may be turned on to remove unpleasant odor or smoke.

- To eliminate the hazard of reaching over hot surface burners, cabinet storage should not be provided directly above a unit.

If such storage is provided, it should be limited to items which are used infrequently and which are safely stored in an area subjected to heat from an appliance.

Temperatures in storage areas above the unit may be unsafe for some items, such as volatile liquids, cleaners or aerosol sprays.

(continued next page)

IMPORTANT SAFETY INSTRUCTIONS (continued)

CLEANING SAFETY:

- Turn off all controls and wait for range parts to cool before touching or cleaning them. Do not touch the burner grates or surrounding areas until they have had sufficient time to cool.

- Clean range with caution. If a wet sponge or cloth is used to wipe spills on a hot cooking area, be careful to avoid steam burns. Some cleaners can produce noxious fumes if applied to a hot surface.

- Touching a hot oven light bulb with a damp cloth could cause the bulb to break. Should the bulb break, disconnect power to the range before trying to remove the bulb to avoid electrical shock.

COOKING SAFETY:

- Be sure you know which knob controls which surface burner. Always make sure the correct burner is turned on and that the burner has ignited. When cooking is completed, turn burner off.

- Always adjust surface burner flame so that it does not extend beyond the bottom of utensil. An excessive flame is hazardous and wastes energy.

- Never leave a surface cooking operation unattended especially when using a high heat setting. Boilovers cause smoking and greasy spillovers may ignite.

- Always turn surface burner to OFF before removing cookware.

- Never heat an unopened container on the surface burner or in the oven. Pressure build-up may cause container to burst resulting in serious personal injury or damage to the range.

- Do not leave any items on the cooktop. The hot air from the vent may ignite flammable items and may increase pressure in closed containers which may cause them to burst.

- Always place oven racks in the desired positions while oven is cool. If a rack must be moved while hot, be careful to avoid contact of pot holders with oven burner flame.

- Slide oven rack out to add or remove food, using dry, sturdy pot holders. Always avoid reaching into oven to place or remove food.

- Use dry, sturdy pot holders. Damp pot holders may cause burns from steam. Dish towels or other substitutes should never be used as pot holders because they can trail across hot surface burners and ignite or get caught on range parts.

- Use care when opening oven door. Let hot air or steam escape before removing or replacing food.

- Use caution when wearing garments made of flammable material to avoid clothing fires. Loose fitting or long hanging-sleeved apparel should not be worn while cooking. Clothing may ignite or catch utensil handles.

- Do not let cooking grease or other flammable materials accumulate in or near the range, range hood or vent fan.

- Always let quantities of hot fat used for deep fat frying cool before attempting to move or handle.

- In the event of a grease fire do not attempt to move pan.

Do not use water on grease fires.

Never pick up a flaming pan. Turn off burner, then smother flaming pan by covering pan completely with a lid, cookie sheet or flat tray. Or, extinguish flame by covering with baking soda or, if available, a multi-purpose dry chemical or foam-type fire extinguisher.

Spills or boilovers which contain grease should be cleaned up as soon as possible. If they are allowed to accumulate, they could create a FIRE HAZARD.

If a grease fire occurs in the oven or in the broiler pan, turn oven off and keep door closed to contain fire until it extinguishes.

PREPARED FOOD WARNING:

- Follow food manufacturer's instructions. If a plastic frozen food container and/or its cover distorts, warps, or is otherwise damaged during cooking, immediately discard the food and its container. The food could be contaminated.

(continued next page)

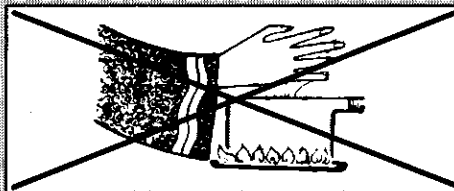
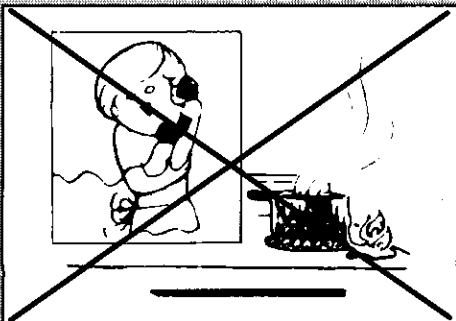

IMPORTANT SAFETY INSTRUCTIONS (continued)

UTENSIL SAFETY:

- Use pans with flat bottoms and handles that are easily grasped and stay cool. Avoid using unstable, warped, easily tipped or loose handled pans. Do not use pans if their handles twist and cannot be tightened. Pans that are heavy to move when filled with food may also be hazardous.
- Always place a pan of food on a surface burner before turning it on, and turn it off before removing the pan to prevent exposure to burner flame.
- Always turn pan handles to the side or back of appliance, not out into the room where they are easily hit or reached by small children.

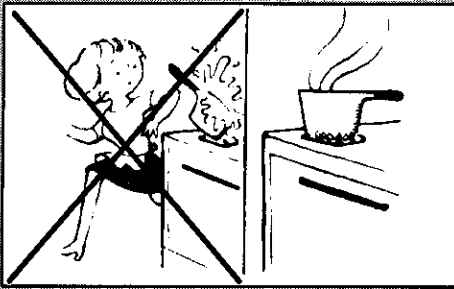

To minimize burns, ignition of flammable materials and spillage due to unintentional contact with the utensil, do not extend handles over adjacent surface burners.

- Be sure utensil is large enough to properly contain food and avoid bollovers. Pan size is particularly important in deep fat frying. Be sure pan will accommodate the volume of food that is to be added as well as the

bubble action of fat. Never leave a deep fat frying operation unattended.

- Never let a pan boil dry as this could damage the utensil and the appliance.
- Many plastics are vulnerable to heat. Keep plastics away from parts of the appliance that may become warm or hot.
- Do not leave plastic items on the cooktop as they may melt or soften if left too close to the vent or a lighted surface burner.
- When using cooking or roasting bags in oven, follow the manufacturer's directions.
- Use only glass cookware that is recommended for use in the oven.
- This appliance has been tested for safe performance using conventional cookware. Do not use any devices or accessories that are not specifically recommended in this manual. Do not use eyelid covers for the surface units, stove top grills, or add-on oven convection systems. The use of devices or accessories that are not expressly recommended in this manual can create serious safety hazards, result in performance problems, and reduce the life of the components of the appliance.

SAVE THESE INSTRUCTIONS

IMPORTANT SAFETY NOTICE AND WARNING

The California Safe Drinking Water and Toxic Enforcement Act of 1986 (Proposition 65) requires the Governor of California to publish a list of substances known to the State of California to cause cancer or reproductive harm, and requires businesses to warn customers of potential exposures to such substances.

Users of this appliance are hereby warned that the burning of gas can result in low-level exposure to some of the listed substances, including benzene, formaldehyde and soot, due primarily to the incomplete combustion of natural gas or liquid petroleum (LP) fuels. Properly adjusted burners will minimize incomplete combustion. Exposure to these substances can also be minimized by properly venting the burners to the outdoors.

CHILD SAFETY:

- Do not leave children alone or unsupervised near the appliance when it is in use or is still hot.

Children should never be allowed to sit or stand on any part of the appliance.

Children must be taught that the appliance and utensils in it can be hot. Let hot utensils cool in a safe place, out of reach of small children.

Children should be taught that an appliance is not a toy.

Children should not be allowed to play with controls or other parts of the unit.

CAUTION: Do not store items of interest to children in cabinets above an appliance or on the backguard of a range.

Children climbing on the appliance to reach items could be seriously injured.

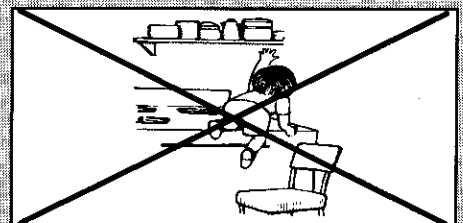

Time-Of-Day Clock

If your range features a time-of-day clock and minute timer follow the instructions for the illustration that matches the clock on your range.

ANALOG CLOCK AND TIMER

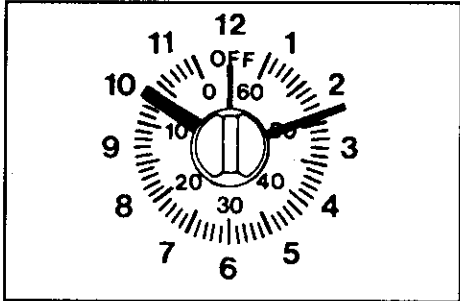

TO SET CLOCK: Push in and turn Minute Timer knob to the correct time of day. Be sure Minute Timer hand is on OFF after setting clock.

TO SET MINUTE TIMER: Turn knob in either direction to the desired time. When the buzzer sounds, manually turn the Timer to OFF.

DIGITAL AND CLOCK TIMER



88:88 will flash in the display when the range is first connected to power or if power is interrupted.

TO SET CLOCK: Press and hold CLOCK SET button while turning MINUTE TIMER knob to the correct time of day. MINUTE TIMER knob can be turned in either direction.

TO SET MINUTE TIMER: Turn MINUTE TIMER knob to the right, to the desired time, up to 60:00 (1 hour). Timer will begin counting down after a few seconds delay. When time has lapsed, a continual beep will sound for up to 2 minutes.

Press CLOCK SET button to stop beep sounds. The correct time of day will reappear in the display.

TO CANCEL A TIMING OPERATION: Turn MINUTE TIMER knob to the left, until 00:00 appears in the display. The correct time of day will reappear in the display after a few seconds delay.

To check time of day during a timing operation, press and hold CLOCK SET button. Time will reappear in the display.

(continued on next page)

Time-Of-Day Clock (continued)

ELECTRONIC CLOCK AND TIMER

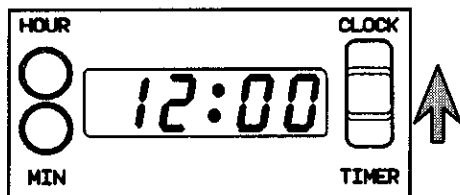

When range is first connected to power or if power is interrupted, 12:00 will flash in the display.

TO SET CLOCK: Slide switch up to CLOCK position.

Press and hold HOUR button until correct hour appears in the display.

Press and hold MIN button until the correct minutes appear in the display.

If you slide the switch up to the CLOCK position during a Minute Timer operation, the operation will be cancelled.

TO SET MINUTE TIMER: Slide switch down to TIMER position. 0:59 will be displayed as soon as the switch is moved to the TIMER position. The timer will automatically begin counting down from one hour in increments of one minute. When time has lapsed, a continual beep will sound. Slide switch to the CLOCK position to stop beeps. The time of day will reappear in the display.

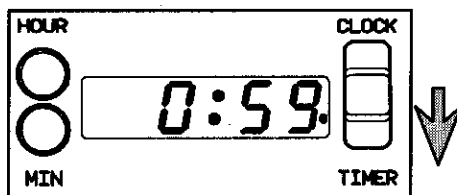

The timing operation will be cancelled if the switch is moved to the CLOCK position.

TO SET A TIMING OPERATION FOR LESS THAN ONE HOUR: Press and hold MIN button until desired time appears in the display. Timer will immediately begin counting down as soon as the MIN button is released.

TO SET A TIMING OPERATION FOR GREATER THAN ONE HOUR: Press the HOUR button. 1:59 will appear in the display. Select desired minutes by pressing and holding MIN button. Timing will begin when button is released.

Two hours is the maximum timing that can be set.

TO CANCEL MINUTE TIMER OPERATION OR STOP "END-OF-TIME" BEEPS: Slide switch up to the clock position. Time of day will reappear in the display.

Surface Cooking

IGNITION SYSTEM

Your range will feature either **pilot** ignition (a standing pilot lights the burner) or **pilotless** ignition (a spark from the ignitor lights the burner).

PILOT IGNITION

To light pilot: Raise cooktop and hold a lighted match near the pilot ports. There are two pilot ports.

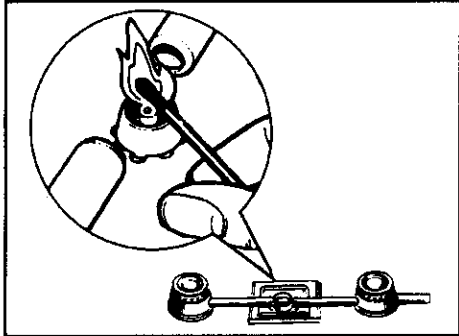

PILOTLESS IGNITION

To operate surface burner during a power failure:

1. Hold a lighted match to the desired surface burner head.
2. Push in and turn knob to the LITE position. The burner will then light.
3. Adjust knob to obtain the desired flame size.

CAUTION: When lighting the surface burner, be sure all of the controls are in the OFF position. Strike the match first and hold it in position before turning the knob to the LITE position.

TO LIGHT SURFACE BURNER

1. Place utensil on burner grate.
2. Push in and turn knob to the LITE position. After the burner lights, turn the knob to the desired flame size.

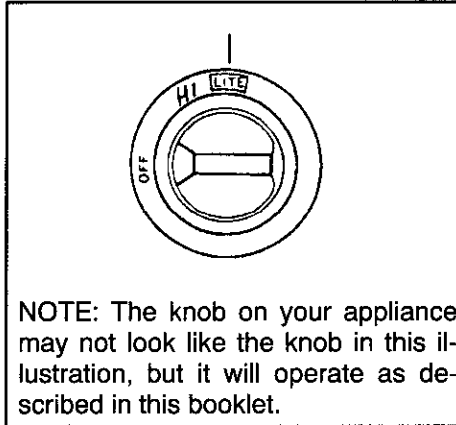

NOTE: The knob on your appliance may not look like the knob in this illustration, but it will operate as described in this booklet.

- PILOTLESS IGNITION -

On models equipped with pilotless ignition a sparking sound will be heard and the burner will light. When one burner is turned on, all four ignitors will spark. The sparking will not stop until the knob is turned from the LITE position.

ABOUT THE SURFACE BURNER FLAME

- A properly adjusted burner with clean ports will light within a few seconds.
- On natural gas, the flame will be blue with a deeper blue core; there should be no trace of yellow in the flame.

A yellow flame indicates an improper mixture of air/gas. This wastes fuel, so have a serviceman adjust the mixture if a yellow flame occurs.

- On LP gas, some yellow tipping is acceptable. This is normal and adjustment is not necessary.

ADDITIONAL INFORMATION

- When the range is first installed, the pilots may be difficult to light due to air in the gas line. To bleed off air from the line, hold a lighted match next to the burner and turn knob on. When the burner lights, turn the knob off and proceed as directed.

- Be sure all surface controls are set in the OFF position prior to supplying gas to the appliance.

- **CAUTION:** If flame should go out during a cooking operation, turn the burner off. **If gas has accumulated and a strong gas odor is detected, wait 5 minutes for the gas to dissipate before relighting burner.**

- You may hear a "popping" sound on LP gas when the surface burner is turned off. This is a normal operating sound of the burner.

- If a knob is turned very quickly from HI to LO setting, the flame may go out, particularly if the burner is cold.

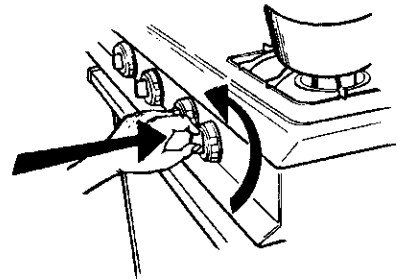

If this occurs, turn the knob to the OFF position. Wait several seconds, then light the burner again.

(continued next page)

Surface Cooking (continued)

FACTORS THAT DETERMINE FLAME SIZE

UTENSIL SIZE: Adjust the flame size so it does not extend beyond the edge of the cooking utensil. This is for personal safety and to prevent possible damage to the appliance, utensil or cabinets above the appliance.

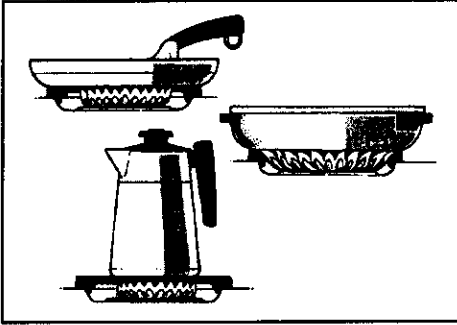

- Utensils which extend more than two inches beyond the grate or touch the cooktop may cause heat to build up, resulting in damage to the burner grate, burner or cooktop.

- Utensils, such as woks with a support ring, which restrict air circulation around the burner will cause heat to build up and may result in damage to the burner grate, burner or cooktop.

UTENSIL MATERIALS: Optimum cooking performance can be achieved when heavy gauge, flat, smooth bottom, metal utensils with straight sides and tight fitting lids are used.

- **Aluminum or aluminum-clad stainless steel** pans heat more evenly so a slightly larger flame can be used.

- **Stainless steel, porcelain and heat-proof ceramic or glass** heat unevenly; **cast aluminum and iron** heat slowly; and, **Teflon-coated** utensils are sensitive to heat. These materials require a lower flame to produce more even cooking results. Adjust flame so it extends halfway to the edge of the utensil bottom.

COVERED UTENSILS: Foods cook faster when the utensil is covered because more heat is retained. Lower the flame size when covering utensils.

SELECTING FLAME SIZE

- Use a **HIGH** flame setting to quickly bring liquids to a boil or to begin a cooking operation. Then reduce to a lower setting to continue cooking. **Never leave food unattended when using a HIGH flame setting.**

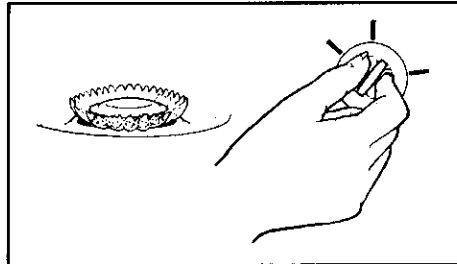

- An intermediate flame size is used to continue a cooking operation. **Food will not cook any faster when a higher flame setting is used than that needed to maintain a gentle boil.** Remember, water boils at the same temperature whether boiling gently or vigorously.

- Use a low flame size to simmer or keep foods at serving temperatures.

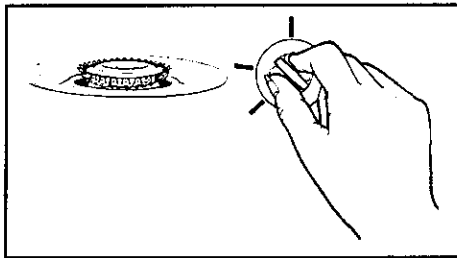

CANNING

Acceptable water-bath or pressure canners should not be oversized and should have a flat bottom. The following are not recommended: Oversized canners or a very large canner that rests on two surface burner grates.

When canning, use the **HIGH** setting just until the water comes to a boil or pressure is reached in the pressure canner, then reduce to the lowest flame setting that maintains the boil or pressure.

Prolonged use of the **HIGH** setting or the use of incorrect canning utensils will produce excessive heat. Excessive heat can cause permanent damage to the appliance.

Using Your Oven

OVEN CHARACTERISTICS

Every oven has its own characteristics. You may find that the cooking times and temperatures you were accustomed to with your previous appliance may need to be altered slightly with your new appliance. It is normal to notice some differences in cooking results between this new appliance and your previous appliance.

IGNITION SYSTEM

Your appliance will feature either **pilot ignition** (a standing pilot lights the oven burner) or **pilotless ignition** (a glo bar lights the oven burner).

Be sure oven control is set in the OFF position prior to supplying gas to the appliance.

PILOT IGNITION

To light oven pilot: When cool, remove oven racks and oven bottom. With the oven thermostat knob in the OFF position, hold a lighted match to the pilot located at the back end of the oven burner. Once pilot lights, replace oven bottom and racks.

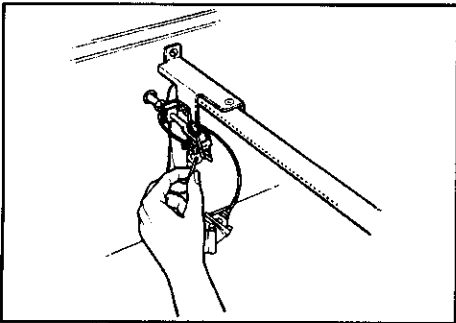

PILOTLESS IGNITION

With this type of ignition system, the oven will not operate during a power failure or if oven is disconnected from the wall outlet. **No attempt should be made to operate oven during a power failure.**

OVEN VENT

The oven vent is located at the base of the backguard. When the oven is in use, this area may feel warm or hot to the touch. To prevent problems do not: Block the vent opening, touch the area near the opening or place utensils near the vent opening.

OVEN BURNER

The size and appearance of a properly adjusted oven burner flame should be as shown:

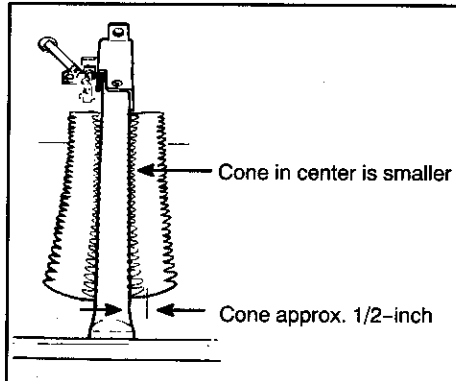

The oven temperature is maintained by cycling the burner on and off. After the oven temperature has been set, there will be about a 45 second delay before the burner ignites. This is normal and no gas escapes during this delay.

OVEN THERMOSTAT

The oven thermostat knob is used to select and maintain the oven temperature. Always turn this knob just to the desired temperature – not to a higher temperature and then back. This provides more accurate oven temperatures. Turn this knob to OFF whenever the oven is not in use.

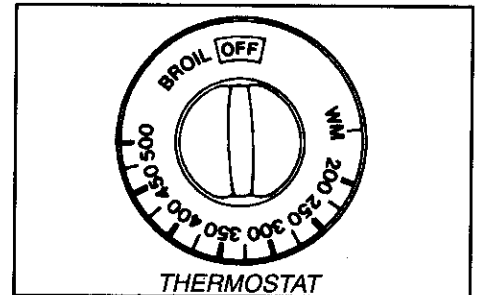

On some models, there is an indent at the 350°F setting.

(continued next page)

Using Your Oven (continued)

TO SET THE OVEN

1. When cool, place the racks in the desired rack positions.
2. Push in and turn the oven thermostat knob to the desired oven temperature. Allow the oven to preheat for 10 to 15 minutes when baking.
3. Place the food in the center of the oven, allowing a minimum of two inches between the utensil(s) and the oven walls.
4. Check the food for doneness at the minimum time given in the recipe. Cook longer if necessary. Opening the oven door frequently causes heat loss which may affect cooking results and increase cooking time.
5. Turn the oven thermostat knob to OFF and remove food from the oven.

PREHEATING

Preheating is necessary for proper baking results. Allow the oven to heat until the desired oven temperature is reached (approximately 10 to 15 minutes). Selecting a temperature higher than the desired temperature will not preheat the oven any faster. In fact, this may have a negative effect on baking results.

It is not necessary to preheat for broiling unless darker browning is desired or if cooking thin (3/4-inch) steaks. Allow burner to preheat 2 to 3 minutes.

Preheating is not necessary for roasting operations.

RACK POSITIONS

- HINTS -

For optimum baking results of cakes, cookies or biscuits, bake on **one rack**. Position rack so food is in the center of the oven. Allow 2 inches between edge of utensil and the oven walls or adjacent utensils.

If cooking on two racks, stagger pans so one is not directly over the other.

Use rack positions 2 and 4, or 2 and 5, depending on baking results, when cooking on two racks.

Use racks 2 and 5 when using two cookie sheets. **Never place two cookie sheets on one rack and never place pans directly on the oven bottom.**

Do not attempt to change the rack positions when the oven is hot.

Use the following guidelines when selecting the proper rack positions:

RACK 1 (top of oven) used for some two rack cooking or baking operations.

RACK 2 used for two-rack baking.

RACK 3 used for most one-rack baking, and roasting some meats.

RACK 4 used for one or two-rack baking; roasting large meats; cooking larger foods or casseroles and for baking angel food cake or cakes in tube or bundt pans.

RACK 5 used for roasting turkey, large cuts of meat, or baking angel food cake, or pie shells.

ROASTING POSITION

Used for roasting taller cuts of meat or turkey. Place both oven racks, one above the other, on the raised sides of the oven bottom.

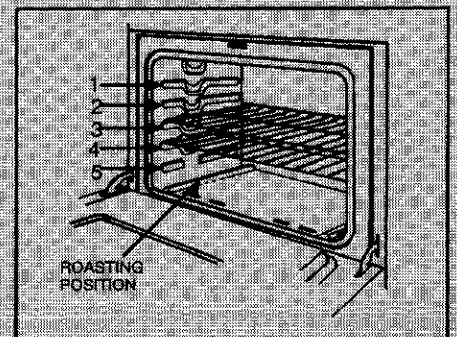

(continued next page)

Using Your Oven (continued)

GENERAL BAKING TIPS

- **Use a reliable recipe** and carefully measure ingredients. **Carefully follow directions** for oven temperature and cooking time.
- **Use the correct rack position.** Baking results may be affected if the wrong rack is used.
 - * Top browning may be darker if food is located toward the top of the oven.
 - * Bottom browning may be darker if food is located toward the bottom of the oven.
 - * When using two racks for baking, allow enough space between the racks for proper air circulation. Browning and cooking results will be affected if air flow is blocked.
- **Utensil material** plays an important part in baking results. Always use the type and size of utensil called for in the recipe. Cooking times or cooking results may be affected if the wrong size utensil is used.
 - * **Shiny metal pan** reflects heat away from the food, produces lighter browning and a softer crust. Use shiny pans for baking cakes or cookies. For optimum baking results, bake cookies and biscuits on a **flat** cookie sheet. If the pan has sides, such as a jelly roll pan, browning may not be even.
 - * **Dark metal pan or a pan with an anodized (dull) bottom** absorbs heat, produces darker browning and a crisper crust. Use this type of pan for pies, pie crusts or bread.
- * If using **oven-proof glassware, or dark pans such as Baker's Secret** reduce the oven temperature by 25°F except when baking pies or bread in glassware. Use the same baking time as called for in the recipe. Use this type of pan for pies or breads.
- **Allow hot air to flow freely through the oven** for optimum baking results. Improper placement of pans in the oven will block air flow and may result in uneven browning. For optimum browning and even cooking results:
 - * Do not crowd a rack with pans. Never place more than one cookie sheet, one 13x9x2-inch cake pan or two round cake pans on one rack.
 - * Stagger pans when baking on two racks so one pan is not directly over another pan.
 - * Allow two inches between the pan and the oven walls.
- **Check the cooking progress at the minimum time** recommended in the recipe. If necessary, continue checking at intervals until the food is done. If the oven door is opened too frequently, heat escapes the oven; this can affect baking results and wastes energy.
- If you added **additional ingredients** or alter the recipe, expect cooking times to increase or decrease slightly.

(continued next page)

Common Baking Problems And Why They Happen

PROBLEM	CAUSE	PROBLEM	CAUSE
<i>Cakes are uneven.</i>	Pans touching each other or oven walls. Batter uneven in pans. Oven temperature too low or baking time too short. Oven not level. Undermixing. Too much liquid.	<i>Cakes don't brown on top.</i>	Incorrect rack position. Temperature too low. Overmixing. Too much liquid. Pan size too large or too little batter in pan. Oven door opened too often.
<i>Cake high in middle.</i>	Temperature too high. Baking time too long. Overmixing. Too much flour. Pans touching each other or oven walls. Incorrect rack position.	<i>Excessive shrinkage.</i>	Too little leavening. Overmixing. Pan too large. Temperature too high. Baking time too long. Pans too close to each other or oven walls.
<i>Cake falls.</i>	Too much shortening or sugar. Too much or too little liquid. Temperature too low. Old or too little baking powder. Pan too small. Oven door opened frequently. Added incorrect type of oil to cake mix. Added additional ingredients to cake mix or recipe.	<i>Uneven texture.</i>	Too much liquid. Undermixing. Temperature too low. Baking time too short.
<i>Cakes, cookies, biscuits don't brown evenly.</i>	Incorrect rack position. Oven door not closed properly. Door gasket not sealing properly. Incorrect use of aluminum foil. Oven not preheated. Pans darkened, dented or warped.	<i>Cakes have tunnels.</i>	Not enough shortening. Too much baking powder. Overmixing or at too high a speed. Temperature too high.
		<i>Cakes crack on top.</i>	Batter overmixed. Temperature too high. Too much leavening. Incorrect rack position.
		<i>Cake not done in middle.</i>	Temperature too high. Pan too small. Baking time too short.
			If additional ingredients were added to mix or recipe, expect cooking time to increase.
<i>Cakes, cookies, biscuits too brown on bottom.</i>	Oven not preheated. Pans touching each other or oven walls. Incorrect rack position. Incorrect use of aluminum foil. Placed 2 cookie sheets on one rack. Used glass, darkened, stained, warped or dull finish metal pans. (Use a shiny cookie sheet.)	<i>Pie crust edges too brown.</i>	Temperature too high. Pans touching each other or oven walls. Edges of crust too thin. Incorrect rack position.
		<i>Pies or cakes don't brown on bottom.</i>	Used shiny metal pans. Temperature too low.
		<i>Pies have soaked crust.</i>	Temperature too low at start of baking. Filling too juicy. Used shiny metal pans.
			For optimum results, bake on one rack. If baking cakes on two racks, stagger pans so one is not directly over another.
			Follow cookware manufacturer's instructions for oven temperature. Glassware and dark cookware such as Ecco's Baker's Secret require lowering the oven temperature by 25° F.

Using Your Oven (continued)

HOW TO BROIL

Broiling is a method of cooking used for tender steaks, chops, hamburgers, chicken, fish, and some fruits and vegetables. The food is placed directly under the oven burner.

The cooking time is determined by the distance between the meat and the burner, the desired degree of doneness, and the thickness of the meat.

GENERAL TIPS

Broiling requires the use of the broiler pan and insert supplied with your appliance. It is designed to drain excess liquid and fat away from the cooking surface to prevent spatters, smoke and flare ups.

For easier clean-up, line the broiler pan (bottom piece) with aluminum foil and spray the insert with a non-stick vegetable coating. Do not cover the broiler pan insert with aluminum foil as this prevents fat from draining into the pan below. The broiler can be preheated for a few minutes. However, **do not preheat the broiler pan and insert.**

If the food is placed too close to the burner, overbrowning and smoking may occur. Generally for a brown exterior and

rare interior, the meat should be close to the burner. Place the pan further down if you wish the meat well done or if spattering and smoking occurs.

The distance from the burner depends on the thickness of the meat and desired degree of doneness. Thin cuts should be placed on rack #1 (top) or #2 (middle); thicker cuts should be placed on rack #2 or #3 (bottom). Broil until the top of the meat is browned. It should be approximately half cooked by the time the top is browned.

Trim excess fat to prevent excessive spattering or smoking. Cut slashes in the outer edges of the meat to prevent curling during cooking.

If you plan to season the meat, it is better to do so after the surface has browned. Salt tends to delay browning which can result in overcooking. Salting before cooking also draws the juices out of the meat, causing dryness.

Never leave a soiled broiler pan and insert in the oven after broiling. Drippings might become hot enough to ignite if exposed directly to the oven burner.

BROILING CHART

Food	Quantity &/or Thickness	Position	Doneness	Approx. Minutes/Side	
				1st Side	2nd Side
Bacon	thick slice	middle	well	4 - 5	1 - 2
Beef Patties	3/4" thick	middle	rare	3 - 4	2 - 3
		middle	medium	5 - 6	3 - 4
		middle	well	5 - 6	4 - 5
Steaks	1" thick	bottom	rare	3 - 4	3 - 4
		bottom	medium	5 - 7	4 - 6
		bottom	well	7 - 8	6 - 7
	1 1/2" thick	bottom	rare	7 - 8	5 - 6
		bottom	medium	8 - 10	6 - 8
		bottom	well	10 - 11	8 - 9
Chicken Breast Halves		bottom	well	8 - 9	7 - 8
Fish Fillets	1" thick	middle		5 - 6	3 - 5
	1/2" thick	middle		4 - 5	3 - 5
Ham Slices (precooked)	1/2" thick	middle		5 - 6	4 - 5
Pork Chops (450°)	1" thick	bottom	well	12 - 14	8 - 9
Weiners/Sausage (precooked)		middle		2 - 4	2 - 3

TO BROIL:

1. Turn the oven THERMOSTAT knob to BROIL.

It is possible to broil longer cooking foods such as pork chops at a lower temperature to prevent overbrowning. Turn the knob to 450°F, rather than BROIL, for low temperature broiling.

2. Preheat for 2 to 3 minutes if desired.

NOTE: Cooking times in the Broil Chart are based on a 2 to 3 minute preheat.

3. Place the broiler pan on the recommended rack position shown in the broiling chart.
4. Follow the suggested times in the broiling chart. Meat should be turned once about halfway through its cooking time.
5. Check the doneness by cutting a slit in the meat near the center to check the color.

Maintenance

COOKTOP

Your range will feature either an upswept cooktop or a flat cooktop. Both tops can be lifted up for convenient access to the burner box area. The flat cooktop can be removed. The upswept top is hinged and can be raised but not removed.

To raise upswept cooktop: When cool, grasp front edge of cooktop and gently lift up until the two support rods at the front of the cooktop snap into place.

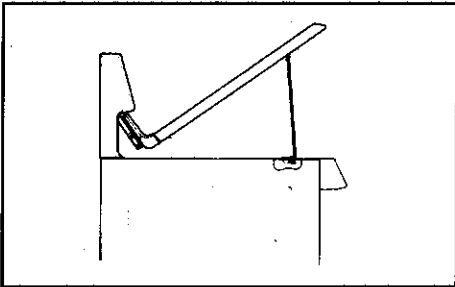

To lower top: Hold front edge of cooktop and carefully push back on each support rod to release the notched support. Then gently lower top into place. The support rods will slide into the range frame.

To remove flat cooktop: When cool, first remove grates and drip bowls, if equipped. Grasp two front burner wells and lift up.

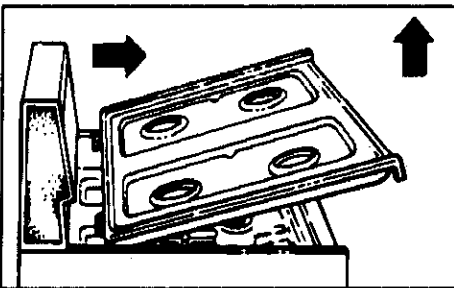

The top can be completely removed or, if equipped with a metal support rod, can rest on the rod. Support rod is located across the front of the burner box.

BURNER GRATES

Burner grates must be properly positioned before cooking. Do not operate the burners without a pan on the grate. The porcelain finish on the grate may chip without a pan to absorb the intense heat.

When reinstalling square grates, place indented sides together so straight sides are at front and rear.

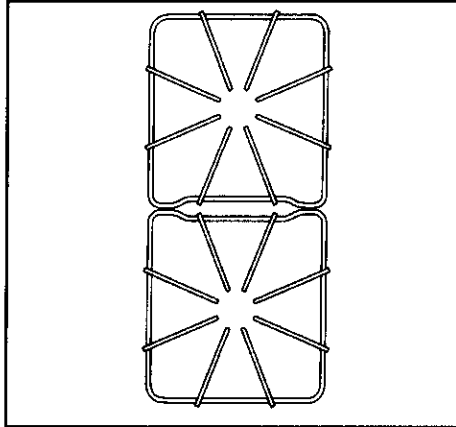

Burner grates are durable but may lose their shine due to usage and high temperatures.

SURFACE BURNERS

Surface burners are secured in place during transportation with spring clips. Once the range is installed, these may be removed to allow quick and easy removal of the burner.

TO REMOVE BURNER:

Allow burner to cool. Lift cooktop. To remove burner, lift up slightly and pull out.

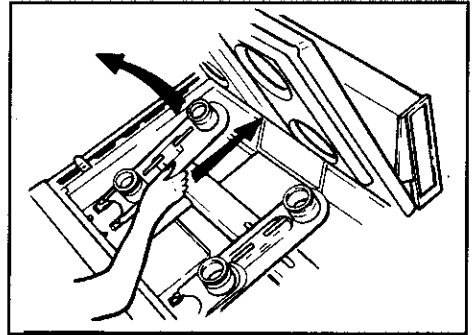

Under no circumstances are burners to be taken apart for cleaning.

(continued next page)

Maintenance (continued)

OVEN DOOR

Do not place excessive weight on an open oven door or stand on an open oven door as, in some cases, it could damage the door, cause the appliance to tip over and possibly cause injury.

When opening oven door, allow steam and hot air to escape before reaching in oven to check, add or remove food.

To remove door: Open door to the "stop" position (opened about 4 inches) and grasp door with both hands at each side. Do not use door handle to lift door. Lift up evenly until door clears the hinge arms.

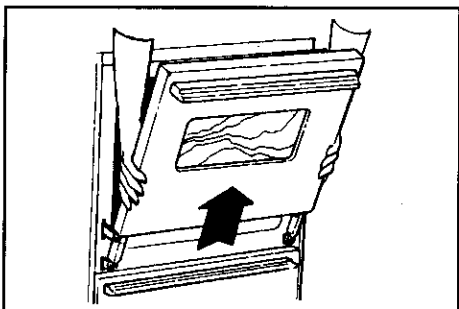

CAUTION: Hinge arms are spring mounted and will slam shut against the range if accidentally hit. **Never place hand or fingers between the hinges and the front oven frame.** You could be injured if hinge snaps back.

To replace door: Grasp door at each side, align slots in the door with the hinge arms and slide door down onto the hinge arms until completely seated on hinges.

Do not attempt to open or close door until door is completely seated on hinge arms. Never turn on oven unless door is properly in place. When baking, be sure door is completely closed. Baking results will be affected if door is not securely closed.

OVEN RACKS

The two oven racks are designed with a lock-stop edge to keep the racks from coming completely out of the oven.

To remove: Be sure the rack is cool. Pull the rack straight out until it stops. Tilt the front of the rack up and continue pulling the rack out of the oven.

To replace: Tilt the front end of the rack up and place the rack between the rack supports. Slide it back until it clears the lock-stop position. Lower the front and slide the rack straight in. Pull the rack out to the lock-stop position to be sure it is positioned correctly and then return it to its normal position.

OVEN BOTTOM

Protect oven bottom against excessive spillovers especially acid or sugary spillovers as they may discolor the porcelain. Use the correct size cooking utensil to avoid boilovers. Never place cookware or aluminum foil directly on the oven bottom.

To remove: When cool, remove the oven racks. Slide the two catches, located at each rear corner of the oven bottom, toward the front of the oven.

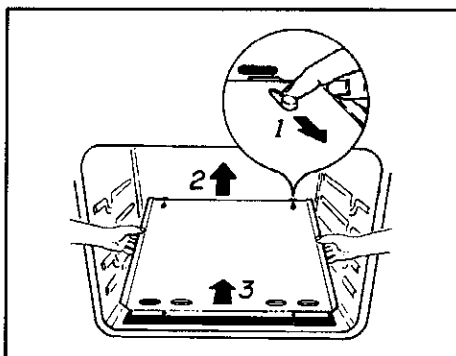

Lift the rear edge of the oven bottom slightly, then slide it back until the front edge of the oven bottom clears the oven front frame. Remove oven bottom from oven.

To replace: Fit front edge of oven bottom into front frame. Lower rear of oven bottom and slide the catches back to lock oven bottom into place.

BROILER DRAWER

Store clean broiler pan and insert in the broiler drawer.

To remove: Pull drawer out to the first stop position. Lift up front of drawer and pull to the second stop position. Grasp sides and lift up and out to remove drawer. Gently move drawer side-to-side as you pull the drawer out.

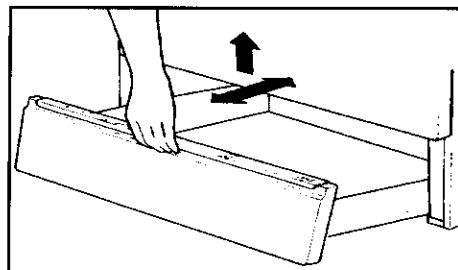

To replace: Fit ends of drawer glides onto rails. Lift up drawer front and gently push in to first stop position. Gently move drawer side-to-side as you push in the drawer. Lift up drawer again and continue to slide drawer to the closed position.

Maintenance (continued)

OVEN LIGHT

The oven light switch is marked "OVEN" and is located on the backguard or on the manifold panel.

Before replacing oven light bulb, DISCONNECT POWER TO RANGE. Be sure bulb and range parts are cool. Do not touch a hot bulb with a damp cloth as the bulb may break.

To replace oven light: Use a dry pot holder, to prevent possible harm to hands; **very carefully** remove bulb. Replace with a 40 watt APPLIANCE bulb. Reconnect power to the range.

LEVELING LEGS

Some floors are not level. For proper baking, your range must be level.

Leveling legs are located on each corner of the base of the range.

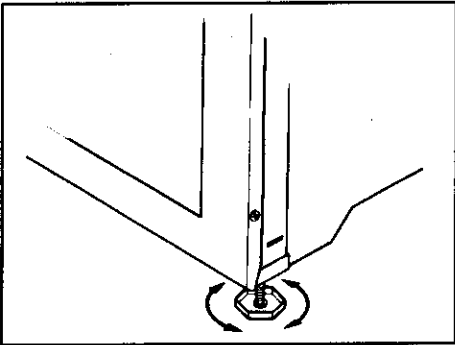

Place a level horizontally on an oven rack and check front-to-back and side-to-side. Level by turning the legs.

HOW TO REMOVE RANGE FOR CLEANING AND SERVICING

Follow these procedures to remove appliance for cleaning or servicing:

1. Shut-off gas supply to appliance.
2. Disconnect electrical supply to appliance, if equipped.
3. Disconnect gas supply tubing to appliance.
4. Slide range forward to disengage range from the anti-tip bracket. (See Installation Instructions for location of bracket.)
5. Reverse procedure to reinstall. If gas line has been disconnected, check for gas leaks after reconnection. (See Installation Instructions for gas leak test method.)

NOTE: A qualified servicer should disconnect and reconnect the gas supply.

To prevent range from accidentally tipping, range must be secured to the floor by sliding rear leveling leg into an anti-tip bracket supplied with the range.

WARNING: Possible risks may result from abnormal usage, including excessive loading of the oven door and of the risk of tip over, should the appliance not be reinstalled according to the installation instructions.

PROPORTIONAL VALVE ADJUSTMENT (if equipped)

The LOW setting should produce a stable flame when turning the knob from HI to LO. The flame should be 1/8 inch or lower and must be stable on all ports on LOW setting.

To adjust: Operate burner on HI for about 5 minutes to preheat burner cap. Turn knob back to LO; remove knob, and insert a small screwdriver into the center of the valve stem. Adjust flame size by turning adjustment screw in either direction.

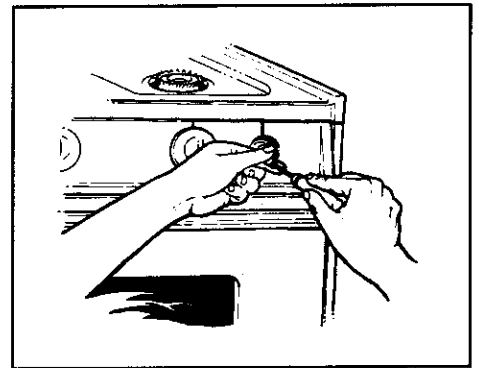

Flame must be of sufficient size to be stable on all burner ports. If flame adjustment is needed, adjust **ONLY** on the LO setting. Never adjust flame size on a higher setting.

NOTE: All gas adjustments should be done by a qualified servicer only.

General Information

ELECTRICAL CONNECTION

Appliances which require electrical power are equipped with a **three-prong grounding plug** which must be plugged directly into a properly grounded three-hole 120 volt electrical outlet.

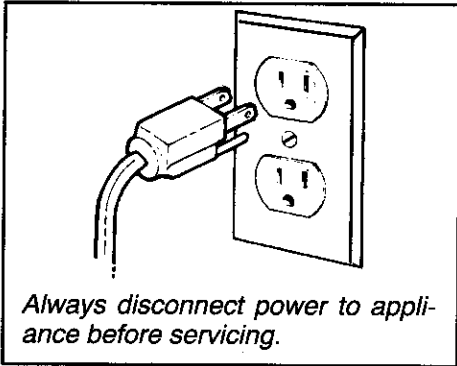

Always disconnect power to appliance before servicing.

The three-prong grounding plug offers protection against shock hazards. **DO NOT CUT OR REMOVE THE THIRD GROUNDING PRONG FROM THE POWER CORD PLUG.**

If an ungrounded, two-hole or other type electrical outlet is encountered, it is the personal responsibility of the appliance owner to have the outlet replaced with a properly grounded three-hole electrical outlet.

USE OF ALUMINUM FOIL

Use aluminum foil **ONLY** as instructed in this book. Improper use of aluminum foil may cause damage to the oven, affect cooking results, and can also result in shock and/or fire hazards.

Foil can be used if these guidelines are followed:

- **Do not use aluminum foil directly under the cookware.** Foil will reflect heat away from the utensil causing inadequate browning. Placing a pie directly on foil may result in a soggy bottom crust and inadequate browning.
- **Do not place aluminum foil directly on the oven bottom as this may damage the oven bottom.** A piece of foil that is slightly larger than the cooking utensil can be placed on the rack directly below the rack containing the utensil.
- **Do not completely cover an oven rack with foil.** This blocks air flow in the oven, constitutes a safety hazard, and will adversely affect cooking results.
- **Never cover the broiler insert with aluminum foil as this prevents fat from draining to the pan below.** The broiler pan can be lined with foil.

Care and Cleaning

The following are examples of recommended cleaning agents. Brand names for cleaning agents are trademarks of the respective manufacturers. **ALWAYS READ AND FOLLOW LABEL or PACKAGE DIRECTIONS WHEN USING ANY CLEANING AGENT.**

1. Glass cleaners – Windex, Glass Plus, Cinch.
2. Mild liquid cleaners – Fantastik or Formula 409.
3. Mildly abrasive cleaners – Bon Ami, paste of baking soda and water.
(If the powdered cleanser is recommended for use on plastic, glass, or porcelain finishes, it can be used on the same appliance finishes.)
4. Plastic or nylon scouring pad – Tuffly, Chore Boy Plastic Cleaning Puff.
5. Oven cleaners – Mr. Muscle, Easy-Off.

Oven cleaners are very caustic; read and follow label directions. Use **ONLY** in the porcelain oven. Do not use oven cleaner in continuous clean oven or on any other range part. Oven cleaners will permanently damage (stain, etch or dull) any range finish except porcelain enamel oven walls.

Be sure range is off and all parts are cool before handling or cleaning to avoid damage. If a part is removed, be sure it has been correctly replaced after cleaning.

CLEANING CHART

PARTS	CLEANING AGENTS	DIRECTIONS
Baked Enamel or Porcelain Enamel • Cooktop • Oven door • Broiler drawer • Side panels • Backguard	<ul style="list-style-type: none"> • Soap and water • Paste of baking soda and water • Mild liquid cleaner • Glass cleaner 	Use a dry towel or cloth to wipe up spills, especially acid (milk, lemon juice, fruit, mustard, tomato sauce) or sugary spills. Surface may discolor or dull if soil is not immediately removed. This is especially important for white surfaces. When surface is cool, wash with warm soapy water, rinse and dry. For stubborn soil, use mildly abrasive cleaning agents such as baking soda paste or Bon Ami. If desired, a thin coat of mild appliance wax can be used to protect the side panels. A glass cleaner can be used to add "shine" to the surface. NOTE: Do not use abrasive, caustic or harsh cleaning agents such as steel wool pads or oven cleaners. These products will scratch or permanently damage the surface. NOTE: Never wipe a warm or hot surface with a damp cloth as this may damage the surface and may cause a steam burn.
Broiler pan and insert	<ul style="list-style-type: none"> • Soap and water • Plastic scouring pad • Soap-filled scouring pad • Dishwasher 	Remove from oven after use. Cool then pour off grease. Place soapy cloth over insert and pan; let soak to loosen soil. Wash in warm soapy water. Use soap-filled scouring pad to remove stubborn soil. Clean in dishwasher if desired. NOTE: For easier cleanup, spray insert with a non-stick vegetable coating and line broiler pan with aluminum foil. NOTE: Always store clean broiler pan and insert in the broiler compartment. If pan and insert are not cleaned after each use, the soil might become hot enough to ignite the next time the oven is used.
Burner box	<ul style="list-style-type: none"> • Soap and water • Paste of baking soda and water • Non-abrasive plastic pad or sponge • Liquid cleaner • Glass cleaner 	Burner box, located under lift-up cooktop, should be cleaned frequently to remove spill-lovers. If soil is not removed and is allowed to accumulate, it may damage the finish. To clean remove grates and surface burners and clean with soap and water, rinse and dry.
Chrome drip bowls, if equipped	<ul style="list-style-type: none"> • Soap and water • Paste of baking soda and water • Plastic scouring pad 	Clean bowls after each use with soap and water. Remove stubborn stains with baking soda paste and plastic scouring pad. To prevent scratching the finish, do not use abrasive cleaning agents. Rinse, dry and replace. NOTE: Bowls can permanently discolor if exposed to excessive heat or if soil is allowed to bake on.
Control knobs	<ul style="list-style-type: none"> • Soap and water 	To remove knobs for cleaning, gently pull forward. Wash in mild detergent and water. Do not soak knobs in water. Do not use abrasive cleaning agents. They will scratch finish and remove markings. Rinse dry and replace. Turn ON each burner to see if knobs have been replaced correctly.

(continued on next page)

Care and Cleaning (continued)

PARTS	CLEANING AGENTS	DIRECTIONS
Glass <ul style="list-style-type: none"> • Backguard • Oven window 	<ul style="list-style-type: none"> • Soap and water • Paste of baking soda and water • Glass cleaner 	<p>Wash with soap and water. Use a window cleaner and a soft cloth after cleaning. Remove stubborn soil with paste of baking soda and water. Rinse with a cloth wrung out in clear water. Dry. Do not use abrasive materials such as scouring pads, steel wool or powdered cleaning agents.</p> <p>NOTE: To avoid inside staining of oven door glass, do not oversaturate cloth.</p>
Grates	<ul style="list-style-type: none"> • Detergent and water • Non-abrasive plastic pad 	<p>Grates are made of porcelain-coated steel. They can be cleaned at the sink with detergent and water or in the dishwasher. To clean baked on soil, place a damp soapy paper towel over the grate and let stand for 30 minutes. Use a non-abrasive plastic pad to scour stubborn soil.</p> <p>NOTE: Never operate burner without a grate in place. To protect the porcelain finish on the grate from excessive heat, never operate surface burner without a cooking utensil on the grate. It is normal for grates to lose their shine over a period of time.</p>
Metal finishes <ul style="list-style-type: none"> • Backguard • Trim parts • Manifold panel 	<ul style="list-style-type: none"> • Soap and water • Paste of baking soda and water • Glass cleaner 	<p>Wash with soap and water. Remove stubborn soil with paste of baking soda and water. Use a window cleaner and a soft cloth to remove fingermarks or smudges.</p> <p>NOTE: Do not use oven cleaners, abrasive or caustic agents. They will damage the finish.</p>
Oven bottom <ul style="list-style-type: none"> • Porcelain enamel 	<ul style="list-style-type: none"> • Soap and water • Paste of baking soda and water • Non-abrasive plastic pad • Oven cleaner 	<p>Continuous clean oven bottom: See page 19.</p> <p>Porcelain oven bottom: Clean, when cool, with soap and water, non-abrasive plastic pad or oven cleaner. Rinse with clear water. To make cleaning easier, protect the oven bottom by (1) using large enough cookware to prevent boilovers; (2) place a piece of aluminum foil, that is slightly larger than the cookware, on the lower rack. NEVER place foil directly on the oven bottom.</p> <p>Protect oven bottom against acid spills (milk, cheese, tomato, lemon juice, etc.) or sugary spills (pie filling) as they may pit or discolor the oven bottom.</p> <p>For easier cleaning, oven bottom can be removed and cleaned at the sink. Do not soak or immerse oven bottom in water or place under running water.</p>
Oven cavity <ul style="list-style-type: none"> • Continuous clean oven <p>See page 19</p>	<p>Cleaning action begins whenever the oven is on. The oven must be used for cleaning to take place. Higher oven temperatures and longer baking times speed the cleaning action.</p>	<p>Brush off heavy soil with a nylon or plastic pad. Do not use paper towels, cloths, or sponges because the oven walls are porous and particles of these materials will rub off on the walls. Rinse area with clean water only. Do not use any type of oven cleaner, cleanser or detergent on this surface.</p>
Oven cavity <ul style="list-style-type: none"> • Porcelain oven 	<ul style="list-style-type: none"> • Soap and water • Mild abrasive cleaners • Plastic pad • Oven cleaner 	<p>Clean oven interior with soap and water; rinse. Use cleansing powders or a plastic scouring pad to remove stubborn soil. Wipe acid or sugar stains as soon as the oven is cool as these stains may discolor or etch the porcelain. Do not use metallic scouring pads as they will scratch the porcelain. To make cleaning easier, place 1/2 cup household ammonia in a shallow glass and leave in a cold oven overnight. The ammonia fumes will help loosen the burned on grease and food. Oven cleaners can be used on the porcelain oven but follow manufacturer's directions. If oven cleaner was used, thoroughly rinse oven cavity and capillary tube which is located at the top of the oven. Oven cleaners can not be used on the continuous cleaning oven finish.</p>
Oven racks	<ul style="list-style-type: none"> • Soap and water • Cleansing powders • Plastic pad • Soap filled scouring pad 	<p>Clean with soapy water. Remove stubborn soil with cleansing powder or soap filled scouring pad. Rinse and dry.</p> <p>NOTE: If racks become difficult to slide, a thin coat of vegetable oil on the underside of the rack will make sliding easier.</p>
Plastic finishes <ul style="list-style-type: none"> • Door handles • Backguard trim • Overlays • Knobs • End caps 	<ul style="list-style-type: none"> • Soap and water • Paste of baking soda and water • Non-abrasive plastic pad or sponge 	<p>When surface is cool, clean with soap and water; rinse, and dry. Use a window cleaner and a soft cloth.</p> <p>NOTE: Never use oven cleaners, abrasive or caustic liquid or powdered cleaning agents on plastic finishes. These cleaning agents will scratch or mar finish.</p> <p>NOTE: To prevent staining or discoloration, wipe up fat, grease or acid (tomato, lemon, vinegar, milk, fruit juice, marinade) immediately with a dry paper towel or cloth.</p>
Silicone rubber <ul style="list-style-type: none"> • Door gasket 	<ul style="list-style-type: none"> • Soap and water 	<p>Wash with soap and water, rinse and dry. Do not remove door gasket.</p>
Surface burners	<ul style="list-style-type: none"> • Soap and water • Paste of baking soda and water • Plastic scouring sponge or pad 	<p>Clean as necessary with warm soapy water. Remove stubborn soil by scouring with a non-abrasive plastic scouring pad and a paste of baking soda and water. Clean ports with a straight pin. Do not enlarge or distort the ports. Do not use a wooden toothpick. It may break off and clog port. DO NOT CLEAN BURNERS WITH THE FOLLOWING caustic cleaners: oven cleaners, steel wool or abrasive cleaning agents. These may damage finish. Burners can be dried in the oven set at 140°F. CAUTION: Burner and burner tube must be dry before use.</p>

Care and Cleaning (continued)

CONTINUOUS CLEANING OVEN (if equipped)

WHAT IS THE CONTINUOUS CLEANING OVEN?

The finish of the Continuous Cleaning Oven is identified by its dark gray color, and rough, porous texture. The rough texture prevents grease spatters from forming beads which run down the walls leaving unsightly streaks. Rather, the rough texture absorbs spatters and allows them to spread, thus exposing a larger area to the hot oven air. The catalyst, when exposed to heat, speeds the oxidation of soil.

Cleaning action automatically begins whenever the oven is turned on for baking or roasting. The oven **MUST** be "on" for cleaning to take place. No cleaning will occur when the oven is off. The special catalytic finish must be exposed to hot oven air before soil will begin to gradually reduce in size.

FACTORS AFFECTING LENGTH OF CLEANING TIME

The higher the oven temperature, the faster the cleaning action. The length of cleaning time will depend on these factors: Type of soil, amount or size of soil, oven temperature and length of time oven is in use. Time may vary from a few minutes to several hours. Soil deposited at the end of a cycle may still be visible. This will usually fade with continued oven use until the soil gradually disappears or can be wiped up manually. The oven will appear presentably clean, even though some spatters may be present.

MANUALLY CLEANING HEAVY SPILLOVERS

The special finish will clean most spatters during normal oven use unless there is a heavy buildup of soil. Heavy spillovers such as pie or casserole boilovers will not clean effectively without some manual help. The crusty or varnish-like stains that form from these spillovers clog the pores and prevent the special finish from being exposed to the hot oven air. This greatly reduces the cleaning effectiveness of the finish.

These crusty or varnish-like stains must either be removed or broken up before cleaning can effectively take place.

TO MANUALLY CLEAN HEAVY SPILLOVERS

Brush off heavy soil with a nylon brush or plastic pad. **DO NOT USE** paper towels, cloths or sponges for the oven walls are porous and particles of these materials will rub off on the walls. Rinse area with clear water only.

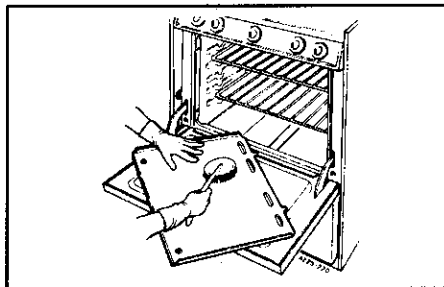

HINTS

Brittle crusts or stains can be loosened by **GENTLY** tapping stain with a wooden or plastic utensil. Brush away any loose soil that flakes off. Varnish type stains usually need to be softened with a small amount of water or damp cloth. Remaining soil will gradually reduce with continued oven use at normal baking temperatures.

DO NOT USE ANY TYPE OF OVEN CLEANER, POWDERED CLEANSERS, SOAP, DETERGENT OR PASTE ON ANY CONTINUOUS CLEANING SURFACE. ALSO, DO NOT USE ANY ABRASIVE MATERIALS, STEEL WOOL, SHARP INSTRUMENTS OR SCRAPERS FOR THEY WILL DAMAGE THE FINISH.

Avoid spillovers by using utensils that are large enough to hold food. A cookie sheet or piece of aluminum foil, just a little larger than the pan, can be placed on the rack directly below the rack holding the utensil to catch spills.

Over a period of time, wear marks may appear on the embossed rack supports. This is normal and results from sliding the racks in and out of the oven. Wear marks will not affect the cleaning action of the oven.

Service

BEFORE CALLING A SERVICE TECHNICIAN, CHECK THE FOLLOWING:

PROBLEM	CAUSE	CORRECTION
1. Surface burner fails to light	<ul style="list-style-type: none"> a. pilots are not lit (pilot ignition) b. power supply not connected (pilotless ignition) c. clogged burner port(s) d. burners not placed correctly onto gas valve e. surface control not completely turned to the LITE position or turned too quickly from the LITE position (pilotless ignition) f. power failure (pilotless ignition) 	<ul style="list-style-type: none"> a. see page 6 to light pilots b. connect power, check circuit breaker or fuse box c. clean ports with straight pin d. remove and reinstall burner properly e. turn control to the LITE position until the burner ignites, then turn control to desired flame size f. see page 6 to light burner during a power failure
2. Burner flame uneven	<ul style="list-style-type: none"> a. clogged burner port(s) b. burner not properly positioned 	<ul style="list-style-type: none"> a. clean ports with straight pin b. see page 13 to correctly replace burner
3. Surface burner flame <ul style="list-style-type: none"> • lifts off port • yellow in color 	<ul style="list-style-type: none"> a. air/gas mixture not proper <p>NOTE: Some yellow tipping with LP gas is normal and acceptable.</p>	<ul style="list-style-type: none"> a. call serviceman to adjust burner
4. Oven burner fails to light	<ul style="list-style-type: none"> a. power supply not connected (pilotless ignition) b. pilot is out (pilot ignition) c. power failure (pilotless ignition) 	<ul style="list-style-type: none"> a. connect power, check circuit breaker or fuse box b. see page 6 to light pilots c. an oven equipped with pilotless ignition will not operate during a power failure or if disconnected from power. See page 8
5. Popping sound heard when burner extinguishes	This is a normal sound that occurs with some types of gas when a hot burner is turned off. The popping sound is not a safety hazard and will not damage the appliance.	
6. Clock and/or oven light does not work	<ul style="list-style-type: none"> a. power supply not connected b. bulb may be loose or burned out c. malfunctioning switch, starter or ballast d. malfunctioning clock or loose wiring 	<ul style="list-style-type: none"> a. connect power supply, check circuit breaker or fuse box b. tighten or replace light bulb c. call serviceman to check d. call serviceman to check
7. Moisture condensation on oven window, if equipped	<ul style="list-style-type: none"> a. it is normal for the window to fog during the first few minutes the oven is on b. cloth saturated with water is used to clean the window 	<ul style="list-style-type: none"> a. leave door ajar for one or two minutes to allow moisture to escape b. Use a damp cloth to clean window to prevent excess water from seeping between the panels of glass
8. Oven temperature inaccurate <ul style="list-style-type: none"> • food takes too long or cooks too fast • pale browning • food over-done on outside and under-done in center • over browning 	<ul style="list-style-type: none"> a. oven not preheated b. incorrect rack position c. incorrect use of aluminum foil d. oven bottom incorrectly replaced e. oven thermostat sensing device out of holding clip(s) 	<ul style="list-style-type: none"> a. preheat oven 10 to 15 minutes b. see page 9 c. see page 16 d. replace oven bottom correctly e. reinstall sensing device securely into clip(s) <p>See Problem Chart on page 11 See baking tips on page 10</p>
9. Oven smokes excessively during a broil operation	<ul style="list-style-type: none"> a. food too close to burner b. meat has too much fat c. sauce applied too early or marinade not completely drained d. soiled broiler pan e. broiler insert covered with aluminum foil 	<ul style="list-style-type: none"> a. move broiler pan down one rack position b. trim fat c. apply sauce during last few minutes of cooking. If meat has been marinated, drain thoroughly before cooking d. always clean broiler pan and insert after each use e. never cover insert with foil as this prevents fat from draining to pan below
10. Poor baking results		See pages 9 to 11 for information on baking

Service (continued)

SERVICING

Electrical supply, if equipped, must be disconnected from the wall outlet before servicing appliance.

Do not repair or replace any part of your appliance unless specifically recommended in this manual. All other servicing should be referred to a qualified technician.

HOW TO OBTAIN SERVICE

When your appliance requires service or replacement parts, contact your Dealer or Authorized Servicer. Use only genuine factory or Maycor parts if replacement parts are necessary. Consult the Yellow Pages in your telephone directory under appliance for the service center nearest you. Be sure to include your name, address, and phone number, along with the model and serial numbers of the appliance. (See inside front cover for location of your model and serial numbers.)

If you are unable to obtain service, write to us. Our address is found on the rating plate. See inside front cover for location of rating plate.

If you are not satisfied with the local response to your service requirements, call or write MAYCOR Appliance Parts and Service Company, 240 Edwards Street, S.E., Cleveland, TN 37311, (615) 472-3500. Include or have available the complete model and serial numbers of the appliance, the name and address of the dealer from whom you purchased the appliance, the date of purchase and details concerning your problem.

If you did not receive satisfactory service through your servicer or Maycor you may contact the Major Appliance Consumer Action Panel by letter including your name, address, and telephone number, as well as the model and serial numbers of the appliance.

Major Appliance Consumer Action Panel
20 North Wacker Drive
Chicago, IL 60606

MACAP (Major Appliance Consumer Action Panel) is an independent agency sponsored by three trade associations as a court of appeals on consumer complaints which have not been resolved satisfactorily within a reasonable period of time.

COOKING APPLIANCE

ONE YEAR - FULL WARRANTY

Maycor Appliance Parts and Service Company will repair or replace, without charge, any part of your appliance which has a defect in material or workmanship during the first year after the date of the original installation. This warranty extends to any owner during the one year warranty period when the appliance is located in the United States or Canada.

ADDITIONAL FOUR YEAR - LIMITED WARRANTY

For an additional four year period beyond the first year of the FULL warranty coverage:

- Maycor will replace, at no charge, any smoothtop heating element, solid disc heating element, or gas sealed surface burner which fails to heat as a result of defective workmanship or materials.
- Maycor will replace, at no charge, any smoothtop cooking surface which cracks or breaks during the normal household cooking.

These parts must be installed by an authorized Maycor servicer. Any labor charge required for replacement is NOT covered by this limited warranty. This warranty extends to any owner during the additional four year warranty period when the appliance is located in the United States or Canada.

WHAT IS NOT COVERED BY THESE TWO WARRANTIES:

1. Conditions and damages resulting from any of the following:
 - a. Improper installation, delivery, or maintenance.
 - b. Any repair, modification, alteration or adjustment not authorized by Maycor, or a Maycor authorized servicer.
 - c. Misuse, abuse, accidents or unreasonable use.
 - d. Incorrect electrical current, voltage or supply.
 - e. Improper setting of any control.
2. Warranties are void if the original serial numbers have been removed, altered, or cannot be readily determined.
3. Light bulbs.
4. Products purchased for commercial or industrial use.
5. The cost of service or service call to:
 - a. Correct installation errors.
 - b. Instruct the consumer on the proper use of the product.
 - c. Transport the appliance to a servicer.
6. CONSEQUENTIAL OR INCIDENTAL DAMAGES SUSTAINED BY ANY PERSON AS A RESULT OF ANY BREACH OF THESE WARRANTIES. Some states do not allow the exclusion or limitation of consequential or incidental damages, so the above exclusion may not apply to you.

HOW TO RECEIVE WARRANTY SERVICE

1. Contact the dealer from whom you purchased the appliance or any authorized Maycor servicer to receive warranty service under these warranties.
2. Should you not receive satisfactory warranty service from your local servicer, contact:

Customer Assistance
Maycor Appliance Parts and Service Company
240 Edwards Street, S.E.
Cleveland, TN 37311
(615) 472-3500

3. Have the following information available when requesting warranty service:
 - Your name and address.
 - The model and serial numbers of your appliance.
 - The name and address of your dealer or servicer.
 - The purchase date of your appliance.
 - A clear description of the problem.

The two warranties described above are the only written or expressed warranties given by Maycor. No one is authorized to increase, alter, or enlarge Maycor's responsibilities or obligations under these two warranties. These two warranties give you specific legal rights, and you may also have other rights which vary from state to state.