

# Owner's Guide

## Gas Range With Electronic Clock And Timer

### TABLE OF CONTENTS

<b>IMPORTANT SAFETY INSTRUCTIONS</b> .....	1-3	Roasting tips .....	10
<b>CLOCK AND TIMER</b> , if equipped .....	4	Broiling tips and chart, if equipped .....	11
<b>USING THE COOKTOP</b> .....	5-6	<b>MAINTENANCE</b> .....	12-14
Ignition system .....	5	Cooktop .....	12
How to light surface burner .....	5	Burner grates .....	12
Selecting flame size .....	6	Conventional surface burners, if equipped .....	12
About the surface burner flame .....	6	Sealed surface burners, if equipped .....	12
Adjusting the flame .....	6	Proportional valve adjustment, if equipped .....	13
Cookware considerations .....	6	Leveling legs .....	13
Canning .....	6	Oven door .....	13
<b>USING THE OVEN</b> .....	7-11	Oven bottom .....	14
Ignition system .....	7	Oven light, if equipped .....	14
Oven characteristics .....	7	Lower panel, if equipped .....	14
Use of aluminum foil .....	7	Electrical connection .....	14
Thermostat knob .....	7	<b>CARE AND CLEANING CHART</b> .....	15-16
How to set oven to bake or roast .....	7	<b>SERVICE</b> .....	17-18
Preheating .....	7	How to remove range for cleaning and servicing ..	17
Oven racks .....	8	How to obtain service .....	17
Common baking problems chart .....	9	Before you call for service chart .....	17-18
Baking tips .....	10		

**INSTALLER** Please leave this manual with this appliance.

Be sure appliance has been properly installed.

**CONSUMER** To save you time, energy and money, read and keep this manual for future reference.

The model and serial numbers are found on the rating plate located on the lower range front frame behind the broiler door or lower panel. Use these numbers when requesting service.

Model Number: \_\_\_\_\_

Serial Number: \_\_\_\_\_

Date of Purchase: \_\_\_\_\_

Please keep your sales receipt and/or your cancelled check as proof of purchase should warranty service be needed. Store these documents with this booklet.

# ABOUT YOUR RANGE

## ABOUT YOUR NEW GAS RANGE

Congratulations on your choice of this gas range. As you use your new range, we know you will appreciate the many features that provide excellent performance, ease of cleaning, convenience and dependability.

New features have dramatically changed today's cooking appliances and the way we cook. It is therefore very important to understand how your new gas range operates **BEFORE** you use it for the first time.

In this Owner's Guide, you will find a wealth of information regarding all aspects of your appliance. By carefully following the instructions, you will be able to fully enjoy and properly maintain your new range. **NOTE:** Your appliance may not be equipped with some of the features referred to in this manual.

Should you have any questions about using your new gas appliance, please write to us at this address:

Customer Assistance  
c/o Maytag Customer Service  
P.O. Box 2370  
Cleveland, TN 37320-2370

Be sure to include the model and serial numbers of your appliance. For your convenience, we have provided space on the front cover to record this information.

In our continuing effort to improve the quality and customer satisfaction of our cooking products, we may find it necessary to make changes to our line of appliances without revising the Owner's Guide.

## Read all instructions before using this appliance.

The following instructions are based on safety considerations and must be strictly followed to eliminate the potential risks of fire, electric shock, or personal injury.

**WARNING: If the information in this manual is not followed exactly, a fire or explosion may result causing property damage, personal injury or death.**

- Do not store or use gasoline or other flammable vapors and liquids in the vicinity of this or any other appliance.
- **WHAT TO DO IF YOU SMELL GAS:**
  - Do not try to light any appliance.
  - Do not touch any electrical switch; do not use any phone in your building.
  - Immediately call your gas supplier from a neighbor's phone. Follow the gas supplier's instructions.
  - If you cannot reach your gas supplier, call the fire department.
- Installation and service must be performed by a qualified installer, service agency or the gas supplier.

Have your appliance installed and properly grounded by a qualified installer according to the installation instructions. Have the installer show you the location of the gas shut off valve and how to shut it off in an emergency.

Always disconnect power to appliance before servicing.

To ensure proper operation and avoid possible injury or damage to unit do not attempt to adjust, repair, service, or replace any part of your appliance unless it is specifically recommended in this book. All other servicing should be referred to a qualified installer or servicer.

## TO PREVENT FIRE OR SMOKE DAMAGE

Be sure all packing materials are removed from the appliance before operating it.

Keep area around appliance clear and free from combustible materials, gasoline, and other flammable vapors and materials.

If appliance is installed near a window, proper precautions should be taken to prevent curtains from blowing over burners.

Do not leave any items on the cooktop. The hot air from the vent may ignite flammable items and may increase pressure in closed containers which may cause them to burst.

Many aerosol-type spray cans are **EXPLOSIVE** when exposed to heat and may be highly flammable. Avoid their use or storage near an appliance.

Many plastics are vulnerable to heat. Keep plastics away from parts of the appliance that may become warm or hot. Do not leave plastic items on the cooktop as they may melt or soften if left too close to the vent or a lighted surface burner.

To eliminate the hazard of reaching over hot surface burners, cabinet storage should not be provided directly above a unit. If such storage is provided, it should be limited to items which are used infrequently and which are safely stored in an area subjected to heat from an appliance. Temperatures may be unsafe for some items, such as volatile liquids, cleaners or aerosol sprays.

## IN CASE OF FIRE

Turn off appliance and ventilating hood to avoid spreading the flame. Extinguish flame then turn on hood to remove smoke and odor.

Use dry chemical or foam-type extinguisher or baking soda to smother fire or flame. Never use water on a grease fire.

If fire is in the oven or broiler pan, smother by closing oven door.

- If fire is in a pan on the surface burner, cover pan. Never attempt to pick up or move a flaming pan.

	<b>! WARNING</b>
	<ul style="list-style-type: none"><li>• ALL RANGES CAN TIP AND CAUSE INJURIES TO PERSONS.</li><li>• INSTALL ANTI-TIP DEVICES PACKED WITH RANGE.</li><li>• FOLLOW ALL INSTALLATION INSTRUCTIONS.</li></ul>

## CHILD SAFETY

Do not leave children alone or unsupervised near the appliance when it is in use or is still hot. Children should never be allowed to sit or stand on any part of the appliance.

Children must be taught that the appliance and utensils in it can be hot. Let hot utensils cool in a safe place, out of reach of small children. Children should be taught that an appliance is not a toy. Children should not be allowed to play with controls or other parts of the unit.

**CAUTION:** Do not store items of interest to children in cabinets above an appliance or on the backguard of a range. Children climbing on the appliance or on the appliance door to reach items could be seriously injured.

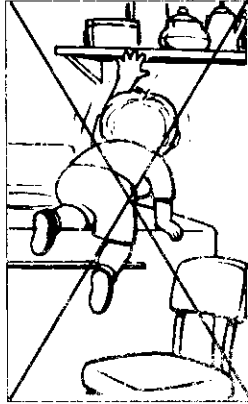

## ABOUT YOUR APPLIANCE

To prevent potential hazard to the user and damage to the appliance, do not use appliance as a space heater to heat or warm a room. Also, do not use the cooktop or oven as a storage area for food or cooking utensils.

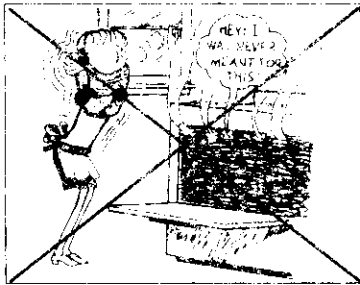

Do not obstruct the flow of combustion and ventilation air by blocking the oven vent or air intakes. Restriction of air flow to the burner prevents proper performance and increases carbon monoxide emission to unsafe levels.

Avoid touching oven vent area while oven is on and for several minutes after oven is turned off. Some parts of the vent and surrounding area become hot enough to cause burns. After oven is turned off, do not touch the oven vent or surrounding areas until they have had sufficient time to cool.

**CAUTION:** Do not use an appliance as a step stool to cabinets above. Misuse of appliance doors or drawers, such as stepping, leaning or sitting on the door or drawer, may result in possible tipping of the appliance, breakage of door, and serious injuries.

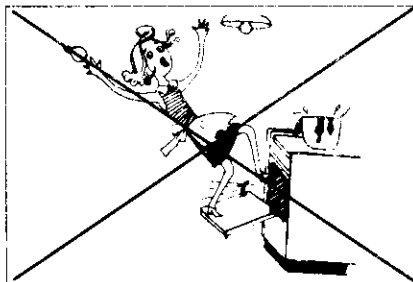

**WARNING:** To reduce the risk of tipping of the appliance from abnormal usage or by excessive loading of the oven door, the appliance must be secured by a properly installed anti-tip device. If the range is moved from the wall, be sure the anti-tip device is engaged when the range is replaced. Look underneath range to verify that one of the rear leveling legs is properly engaged in the bracket slot. The anti-tip device secures the rear leveling leg to the floor when properly engaged. Also, be sure the range is properly re-installed.

Do not touch a hot oven light bulb with a damp cloth as the bulb could break. Should the bulb break, disconnect power to the appliance before removing bulb to avoid electrical shock.

## COOKING SAFETY

Always place a pan on a surface burner before turning it on. Be sure you know which knob controls which surface burner. Make sure the correct burner is turned on and that the burner has ignited. When cooking is completed, turn burner off before removing pan to prevent exposure to burner flame.

Always adjust surface burner flame so that it does not extend beyond the bottom edge of the pan. An excessive flame is hazardous, wastes energy and may damage the appliance, pan or cabinets above the appliance.

Never leave a surface cooking operation unattended especially when using a high heat setting or when deep fat frying. Boilovers cause smoking and greasy splatters may ignite. Clean up greasy spills as soon as possible. Do not use high heat for extended cooking operations.

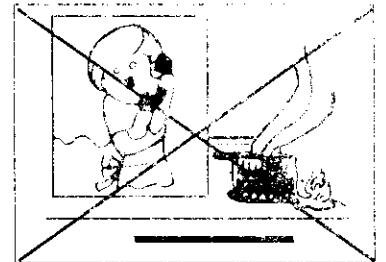

Never heat an unopened container on the surface burner or in the oven. Pressure build-up may cause container to burst resulting in serious personal injury or damage to the appliance.

Use dry, sturdy pot holders. Damp pot holders may cause burns from steam. Dish towels or other substitutes should never be used as pot holders because they can trail across hot surface burners and ignite or get caught on appliance parts.

Always let quantities of hot fat used for deep fat frying cool before attempting to move or handle.

Do not let cooking grease or other flammable materials accumulate in or near the appliance, hood or vent fan. Clean hood frequently to prevent grease from accumulating on hood or filter. When flaming foods under the hood turn the fan off as the fan may spread the flame.

Use caution when wearing garments made of flammable material to avoid clothing fires. Loose fitting or long hanging-sleeved apparel should not be worn while cooking. Clothing may ignite or catch utensil handles.

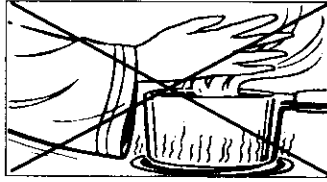

Always place oven racks in the desired positions while oven is cool. Slide oven rack out to add or remove food, using dry sturdy pot holders. Always avoid reaching into the oven to add or remove food. If a rack must be moved while hot, use a dry pot holder. Always turn the oven off at the end of cooking.

Use care when opening the oven door. Let hot air or steam escape before removing or replacing food.

**PREPARED FOOD WARNING:** Follow food manufacturer's instructions. If a plastic frozen food container and/or its cover distorts, warps, or is otherwise damaged during cooking, immediately discard the food and its container. The food could be contaminated.

## UTENSIL SAFETY

Use pans with flat bottoms and handles that are easily grasped and stay cool. Avoid using unstable, warped, easily tipped or loose handled pans. Pans that are heavy to move when filled with food may also be hazardous.

Be sure utensil is large enough to properly contain food and avoid boilovers. Pan size is particularly important in deep fat frying. Be sure pan will accommodate the volume of food that is to be added as well as the bubble action of fat.

To minimize burns, ignition of flammable materials and spillage due to unintentional contact with the utensil, do not extend handles over adjacent surface burners. Always turn pan handles toward the side or back of the appliance, not out into the room where they are easily hit or reached by small children.

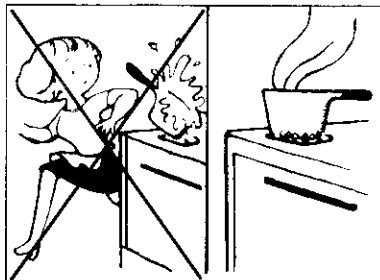

Never let a pan boil dry as this could damage the utensil and the appliance.

Follow the manufacturer's directions when using oven cooking bags.

Only certain types of glass, glass/ceramic, ceramic, or glazed utensils are suitable for cooktop or oven usage without breaking due to the sudden change in temperature.

This appliance has been tested for safe performance using conventional cookware. Do not use any devices or accessories that are not specifically recommended in this manual. Do not use eyelid covers for the surface units, stove top grills, or add-on oven convection systems. The use of devices or accessories that are not expressly recommended in this manual can create serious safety hazards, result in performance problems, and reduce the life of the components of the appliance.

## CLEANING SAFETY

Turn off all controls and wait for appliance parts to cool before touching or cleaning them. Do not touch the burner grates or surrounding areas until they have had sufficient time to cool.

Clean appliance with caution. Use care to avoid steam burns if a wet sponge or cloth is used to wipe spills on a hot surface. Some cleaners can produce noxious fumes if applied to a hot surface.

## IMPORTANT SAFETY NOTICE AND WARNING

The California Safe Drinking Water and Toxic Enforcement Act of 1986 (Proposition 65) requires the Governor of California to publish a list of substances known to the State of California to cause cancer or reproductive harm, and requires businesses to warn customers of potential exposures to such substances.

Users of this appliance are hereby warned that the burning of gas can result in low-level exposure to some of the listed substances, including benzene, formaldehyde and soot, due primarily to the incomplete combustion of natural gas or liquid petroleum (LP) fuels. Properly adjusted burners will minimize incomplete combustion. Exposure to these substances can also be minimized by properly venting the burners to the outdoors by opening the windows and/or door in the room where the appliance is located.

## SAVE THESE INSTRUCTIONS

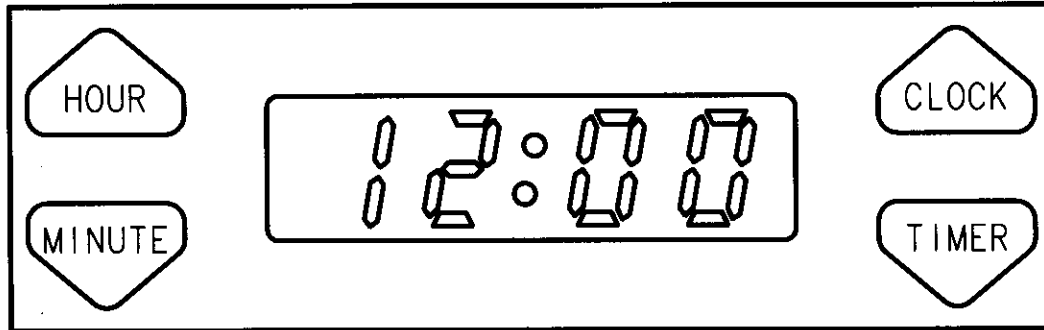

The electronic clock and timer display will flash when the appliance is first connected to power or if power is interrupted. The display will stop flashing once the time-of-day clock has been set.

### TO SET THE TIME-OF-DAY CLOCK

1. Press the CLOCK pad.
2. Press and hold the HOUR pad to set the correct hours. Tap the pad once to change the time by a single hour.
3. Press and hold the MINUTE pad to set the correct minutes. Tap the pad once to change the time by a single minute.

For example: To set the clock for 3:15, press and hold the HOUR pad until 3 appears in the hours display. Then press and hold the MINUTE pad until 15 appears in the minutes display.

### TO SET THE TIMER

1. Press the TIMER pad. 0:59, or one hour, will appear in the display.  
The timer will automatically begin counting down in increments of one minute.
2. **To set the timer for less than one hour:** Press the TIMER pad then press and hold the MINUTE pad until the desired time appears in the display. To change the time by a single minute, tap the pad once.
3. **To set the timer for more than one hour:** Press the TIMER pad then –
  - Press the HOUR pad, 1:59, or two hours, will appear in the display.
  - Press the MINUTE pad until the desired minutes appear in the display.
4. When the time has elapsed, 0:00 will appear in the display and continuous beeps will sound to indicate the end of the timing operation.
5. Press the CLOCK pad to cancel the beeps. The current time of day will reappear in the display.

**To cancel the timer:** Press the CLOCK pad and the display will return to the current time of day.

## IGNITION SYSTEM

Your cooktop will feature either **pilot** ignition or **pilotless** ignition. If the gas supply to the range is turned off, be sure all controls are set in the OFF position before re-supplying gas to the appliance.

### Pilot Ignition

When the range is first installed, the standing pilots may be difficult to light due to air in the gas line. To bleed off air from the line, hold a lighted match next to the burner and turn the knob on. When the burner lights, turn the knob off and proceed as directed below.

**To light pilot:** Raise the cooktop and hold a lighted match near the pilot ports. There are two pilot ports, one on the right side and one on the left side.

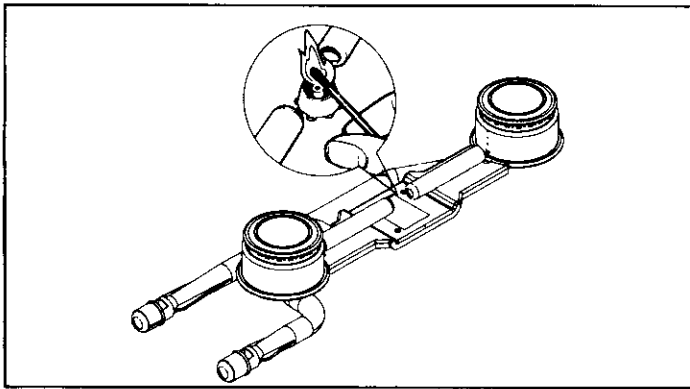

### Pilotless Ignition

Pilotless ignition uses a spark from the ignitor to light the burner. There are two ignitors for conventional surface burners. Each sealed burner has its own ignitor. Once the burner lights, turn the knob to the desired setting. The clicking sound will not stop until the knob is turned from the LITE position.

**NOTE:** The surface burner will not light if the ignitor is damaged, broken, soiled or wet. Also, the burner will not light if the small port beneath the ignitor is blocked. See page 16 for cleaning instructions.

**In the event of a power failure, the surface burner can be manually lighted.** Be sure all controls are in the OFF position. Hold a lighted match to the desired surface burner head then push in and turn the knob to the LITE position. When the burner lights, adjust the flame to the desired flame size.

## HOW TO LIGHT SURFACE BURNER

To prevent damage to the cooktop or pan, never operate the surface burner without a pan in place, never allow a pan to boil dry and never operate a surface burner on HIGH for extended periods of time.

1. Place a pan on the burner grate.

**NOTE:** The burner flame may lift off the burner head and a "roaring" sound may be heard if a pan is not placed on the grate before lighting the burner.

2. Push in and turn the knob to the LITE position.

**Pilotless ignition models only:** A clicking sound will be heard and the burner will light. When one burner is turned on, all ignitors will spark.

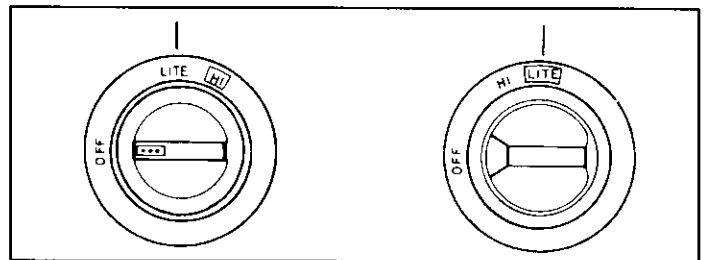

3. After the burner lights, turn the knob to the desired flame size.

**Pilotless ignition models only:** The ignitors will continue to spark until the knob is turned from the LITE position.

**CAUTION:** If the flame should go out during a cooking operation, turn the burner off. If gas has accumulated and a strong gas odor is detected, open a window and wait 5 minutes for the gas odor to disappear before relighting the burner.

## SELECTING FLAME SIZE

Use a HIGH flame setting to quickly bring liquids to a boil or to begin a cooking or canning operation. Then reduce to a lower setting to continue cooking. **Never leave food unattended when using a HIGH flame setting.**

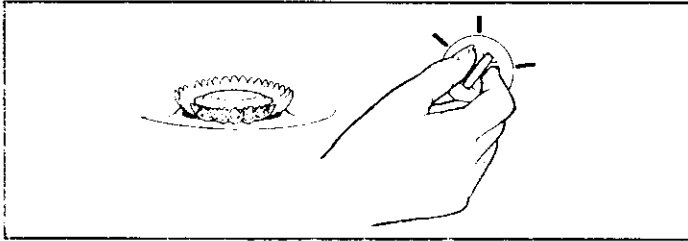

An intermediate flame size is used to continue a cooking operation. **Food will not cook any faster when a higher flame setting is used than needed to maintain a gentle boil.** Remember, water boils at the same temperature whether boiling gently or vigorously.

Use LO to simmer or keep foods at serving temperatures.

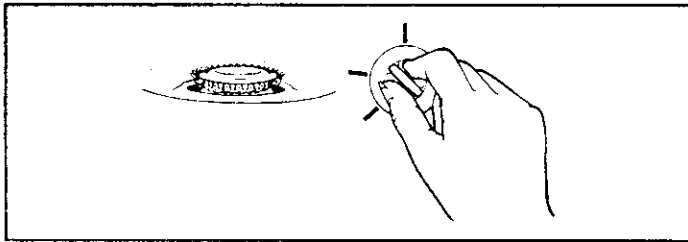

If a knob is turned very quickly from the HI to the LO setting, the flame may go out, particularly if the burner is cold. If this occurs, turn the knob to the OFF position. Wait several seconds, then light the burner again.

## ABOUT THE SURFACE BURNER FLAME

A properly adjusted burner with clean ports will light within a few seconds. **You may hear a "popping" sound on some types of gas when the surface burner is turned off. This is a normal operating sound of the burner.**

On **natural gas**, the flame will be blue with a deeper blue core; there should be no trace of yellow in the flame. A yellow flame indicates an improper mixture of air/gas. Have a serviceman adjust the mixture if a yellow flame occurs. (**NOTE:** Adjustments are not covered by the warranty.)

On **LP gas**, some yellow tipping may occur. This is normal and adjustment is not necessary.

## ADJUSTING THE FLAME

Adjust the flame size so it does not extend beyond the edge of the cooking utensil. This is for personal safety and to prevent possible damage to the appliance, pan, or cabinets above the appliance. This also improves cooking efficiency.

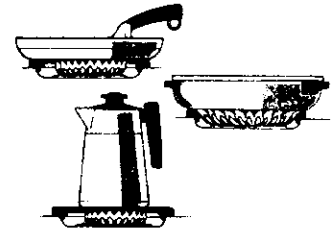

## COOKWARE CONSIDERATIONS

Cookware, including canning equipment, which extends more than two inches beyond the grate, rests on two grates, or touches the cooktop will cause a build up of heat and may result in damage to the burner grate, burner and cooktop.

Cookware, such as a wok with a support ring, which restricts air circulation around the burner will cause heat to build up and may result in damage to the burner grate, burner or cooktop.

Foods cook faster when the cookware is covered because more heat is retained. Lower the flame size when cookware is covered. This also improves cooking efficiency.

The cooking performance is greatly affected by the type of cookware used. Proper cookware will reduce cooking times, use less energy and produce more even cooking results. For best results use a heavy gauge metal pan with a smooth flat bottom, straight sides and a tight fitting lid. Select a material, such as aluminum or copper, that conducts heat quickly and evenly.

## CANNING

When canning, use the HI setting just until the water comes to a boil or pressure is reached in a pressure canner, then reduce to a setting that maintains the pressure or a boil.

Prolonged use of the HI setting, the use of incorrect canning utensils, or the use of improper canning techniques may produce excessive heat and result in permanent damage to the appliance.

**NOTE:** For additional canning information contact your local County Extension Office. Or, contact Alltrista Consumer Products Company, marketer of Ball brand home canning products at 800-240-3340 or write: Alltrista Corp., Consumer Affairs Dept., P.O. Box 2729, Muncie, IN 47307-0729.



## IGNITION SYSTEM

Your oven will feature either **pilot ignition** or **pilotless ignition**. If the gas supply to the range is turned off, be sure all controls are set in the OFF position before re-supplying gas to the appliance.

### Pilot Ignition

**To light oven pilot:** When cool, open the broiler door and remove the broiler rack and broiler pan. On models without a broiling compartment, remove the lower panel. See page 14 for instructions on removing the panel.

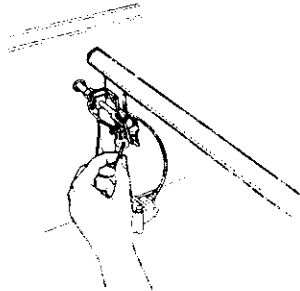

With the Thermostat knob in the OFF position, hold a lighted match to the pilot located at the back of the oven burner. Once the pilot lights, replace the broiler rack and pan or the lower panel. (**NOTE:** The oven burner is shown with the metal flame spreader removed from the oven burner.)

### Pilotless Ignition

With this type of ignition system, a glow bar will light the oven burner. The oven will not operate during a power failure or if the oven is disconnected from the wall outlet. **NOTE: A lighted match will not light the burner. No attempt should be made to operate oven during a power failure.**

## OVEN CHARACTERISTICS

Because each oven has its own personal baking characteristics, do not expect that your new oven will perform exactly like your previous oven. You may find that the cooking times, oven temperatures, and cooking results differ somewhat from your previous range. Allow a period of adjustment. If you have questions concerning baking results, please refer to pages 8, 9, 10 and 18 for additional information.

## USE OF ALUMINUM FOIL

**Do not cover the oven bottom or an entire rack with foil or place foil directly under cookware.** To catch spillovers, place a piece of foil a little larger than the pan, on the rack below the pan. For ranges with one rack, it will be necessary to place the foil directly under the utensil. Cut a small opening in the foil to allow heat to the bottom of the pan. This is especially important when baking pies.

## THERMOSTAT KNOB

The Thermostat knob is used to select and maintain the oven temperature. Push in and turn this knob just to the desired temperature. To provide accurate oven temperatures, do not turn the knob to a higher temperature and then back to the desired temperature. Turn this knob to OFF whenever the oven is not in use.

After the oven temperature has been set, there will be about a 45 second delay before the burner ignites. This is normal and no gas escapes during this delay.

The oven temperature is maintained by cycling the oven burner on and off.

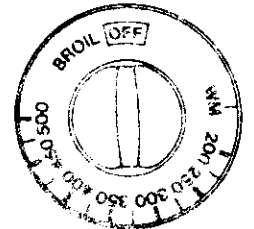

THERMOSTAT KNOB

## HOW TO SET OVEN TO BAKE OR ROAST

1. When cool, position the rack in the oven.
2. Push in and turn the Thermostat knob to the desired temperature.

Selecting a temperature higher than desired will **NOT** preheat the oven any faster and may have a negative effect on baking results.

3. Place the food in the center of the oven, allowing a minimum of 1 to 2-inches between the utensil and the oven walls.

When the oven is in use, the oven vent area at the rear of the cooktop may feel warm or hot to the touch. Do not block this area or the vent opening as this may affect baking results.

4. Check the food for doneness at the minimum time in the recipe. Cook longer if necessary. Cooking time may vary from oven to oven.
5. Remove the food from the oven and turn the Thermostat knob to OFF.

## PREHEATING

Preheating is necessary for baking. To preheat the oven, turn the Thermostat knob to the desired temperature and allow 10 to 15 minutes for the oven to preheat. Selecting a higher temperature will not shorten the preheat time and may affect baking results. It is not necessary to preheat for roasting or broiling.

## OVEN RACKS

Your range will feature one or two oven racks. The oven rack is designed with a safety lock-stop position to keep the rack from accidentally coming completely out of the oven when pulling the rack out to add or remove food.

**CAUTION:** Do not attempt to change the rack positions when the oven is hot.

**To remove:** Be sure the rack is cool. Pull the rack straight out until it stops at the lock-stop position. Tilt the front end of the rack up and continue pulling the rack out of the oven.

**To replace:** Place the rack on the rack supports and tilt the front end of the rack up slightly. Slide it back until it clears the lock-stop position. Lower the front and slide the rack straight in. Pull the rack out to the lock-stop position to be sure it is positioned correctly and then return it to its normal position.

For optimum baking results of cakes, cookies or biscuits, use one rack. Position the rack so the food is in the center of the oven. Use either rack position 2 or 3.

If cooking on two racks, use rack positions 2 and 4 for cakes and rack positions 1 and 4 when using cookie sheets. Never place two cookie sheets on one rack.

## RACK POSITION CHART

<b>RACK 5</b> (highest position)	For two-rack cooking. Use the upper rack position for side dishes when roasting a turkey on the lower rack.
<b>RACK 4</b>	Used for most two-rack baking.
<b>RACK 3</b>	Used for most baked goods on a cookie sheet or jelly roll pan, or frozen convenience foods.
<b>RACK 2</b>	Used for roasting small cuts of meat, large casseroles, baking loaves of bread, cakes (in either tube, bundt, or layer pans) or two-rack baking.
<b>RACK 1</b>	Used for roasting large cuts of meat and large poultry, pies, souffles, or angel food cake, or for two-rack baking.
<b>ROASTING POSITION</b>	If your range features two racks, place both oven racks, one above the other, on the raised sides of the oven bottom. Use this position when roasting taller cuts of meat or a large turkey.

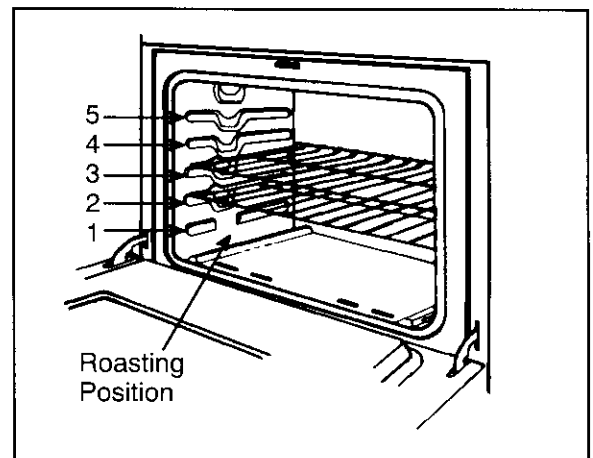

## COMMON BAKING PROBLEMS AND WHY THEY HAPPEN

PROBLEM	CAUSE
<i>Cakes are uneven.</i>	<ul style="list-style-type: none"> <li>• Pans too close or touching each other or oven walls.</li> <li>• Batter uneven in pans.</li> <li>• Temperature set too low or baking time too short.</li> <li>• Oven not level.</li> <li>• Undermixing.</li> <li>• Too much liquid.</li> </ul>
<i>Cake high in middle.</i>	<ul style="list-style-type: none"> <li>• Temperature set too high.</li> <li>• Baking time too long.</li> <li>• Overmixing.</li> <li>• Too much flour.</li> <li>• Pans touching each other or oven walls.</li> <li>• Incorrect rack position.</li> </ul>
<i>Cake falls.</i>	<ul style="list-style-type: none"> <li>• Too much shortening or sugar.</li> <li>• Too much or too little liquid.</li> <li>• Temperature set too low.</li> <li>• Old or too little baking powder.</li> <li>• Pan too small.</li> <li>• Oven door opened frequently.</li> <li>• Added incorrect type of oil to cake mix.</li> <li>• Added additional ingredients to cake mix or recipe.</li> </ul>
<i>Cakes, cookies, biscuits don't brown evenly.</i>	<ul style="list-style-type: none"> <li>• Incorrect rack position.</li> <li>• Oven door not closed properly.</li> <li>• Door gasket not sealing properly or properly attached to door.</li> <li>• Incorrect use of aluminum foil.</li> <li>• Oven not preheated.</li> <li>• Pans darkened, dented or warped.</li> </ul> <p>For optimum results, bake on one rack. If baking cakes on two racks, stagger pans so one is not directly above another.</p>
<i>Cakes, cookies, biscuits too brown on bottom.</i>	<ul style="list-style-type: none"> <li>• Oven not preheated.</li> <li>• Pans touching each other or oven walls.</li> <li>• Incorrect rack position.</li> <li>• Incorrect use of aluminum foil.</li> <li>• Placed 2 cookie sheets on one rack.</li> <li>• Used glass, dark, stained warped or dull finish metal pans. (Use a shiny cookie sheet.)</li> </ul> <p>Follow cookware manufacturer's instructions for oven temperature. Glassware and dark cookware such as Ecco's Baker's Secret may require lowering the oven temperature by 25°F.</p>
<i>Cakes don't brown on top.</i>	<ul style="list-style-type: none"> <li>• Incorrect rack position.</li> <li>• Temperature set too low.</li> <li>• Overmixing.</li> <li>• Too much liquid.</li> <li>• Pan size too large or too little batter in pan.</li> <li>• Oven door opened too often.</li> </ul>
<i>Excessive shrinkage.</i>	<ul style="list-style-type: none"> <li>• Too little leavening.</li> <li>• Overmixing.</li> <li>• Pan too large.</li> <li>• Temperature set too high.</li> <li>• Baking time too long.</li> <li>• Pans too close to each other or oven walls.</li> </ul>
<i>Uneven texture.</i>	<ul style="list-style-type: none"> <li>• Too much liquid.</li> <li>• Undermixing.</li> <li>• Temperature set too low.</li> <li>• Baking time too short.</li> </ul>
<i>Cakes have tunnels.</i>	<ul style="list-style-type: none"> <li>• Not enough shortening.</li> <li>• Too much baking powder.</li> <li>• Overmixing or at too high a speed.</li> <li>• Temperature set too high.</li> </ul>
<i>Cake not done in middle.</i>	<ul style="list-style-type: none"> <li>• Temperature set too high.</li> <li>• Pan too small.</li> <li>• Baking time too short.</li> </ul> <p>If additional ingredients were added to mix or recipe, expect cooking time to increase.</p>
<i>Pie crust edges too brown.</i>	<ul style="list-style-type: none"> <li>• Temperature set too high.</li> <li>• Pans touching each other or oven walls.</li> <li>• Edges of crust too thin; shield with foil.</li> </ul>
<i>Pies don't brown on bottom.</i>	<ul style="list-style-type: none"> <li>• Used shiny metal pans.</li> <li>• Temperature set too low.</li> <li>• Incorrect rack position.</li> <li>• Some frozen pies should be placed on a cookie sheet, check package directions.</li> </ul>
<i>Pies have soaked crust.</i>	<ul style="list-style-type: none"> <li>• Temperature too low at start of baking.</li> <li>• Filling too juicy.</li> <li>• Used shiny metal pans.</li> </ul>

## BAKING TIPS

Use a **reliable recipe** and accurately measure fresh ingredients. **Carefully follow directions** for oven temperature and cooking time. Preheat oven if recommended.

Use the **correct rack position**. Baking results may be affected if the wrong rack position is used.

- \* Top browning may be darker if food is located toward the top of the oven.
- \* Bottom browning may be darker if food is located toward the bottom of the oven.
- \* When using two racks for baking, allow enough space between the racks for proper air circulation. Browning and cooking results will be affected if air flow is blocked.

**Cookware material** plays an important part in baking results. Always use the type and size of pan called for in the recipe. Cooking times or cooking results may be affected if the wrong size is used.

- \* **Shiny metal pan** reflects heat away from the food, produces lighter browning and a softer crust. Use shiny pans for baking cakes or cookies. For optimum baking results, bake cookies and biscuits on a **flat** cookie sheet. If the pan has sides, such as a jelly roll pan, browning may not be even.
- \* **Dark metal pan** or a **pan with an anodized (dull) bottom** absorbs heat, produces darker browning and a

crisper crust. Use this type of pan for pies, pie crusts or bread.

- \* If using **oven-proof glassware**, or **dark pans such as Baker's Secret** reduce the oven temperature by 25°F except when baking pies or bread. Use the same baking time as called for in the recipe.

**Allow hot air to flow freely through the oven** for optimum baking results. Improper placement of pans in the oven will block air flow and may result in uneven browning. For optimum browning and even cooking results:

- \* Do not crowd a rack with pans. Never place more than one cookie sheet, one 13x9x2-inch cake pan or two 9-inch round cake pans on one rack.
- \* Stagger pans when baking on two racks so one pan is not directly over another pan.
- \* Allow one to two inches between the pan and the oven walls.

**Check the cooking progress at the minimum time** recommended in the recipe. If necessary, continue checking at intervals until the food is done. If the oven door is opened too frequently, heat will escape from the oven; this can affect baking results and wastes energy.

**If you add additional ingredients** or alter the recipe, expect cooking times to increase or decrease slightly.

## ROASTING TIPS

Roasting is the method for cooking large, tender cuts of meat uncovered, without adding moisture. Most meats are roasted at 325°F. It is not necessary to preheat the oven. Place the roasting pan on either of the two lowest rack positions or on the special roasting position (see page 8).

Use tender cuts of meat weighing three pounds or more. Some good choices are: Beef rib, ribeye, top round, high quality tip and rump roast, pork loin roast, leg of lamb, veal shoulder roast and cured or smoked hams.

Season meat, if desired, either before or after roasting. Rub into the surface of the roast if added before cooking.

Place the meat fat-side-up on a rack in a shallow roasting pan. Placing the meat on a rack holds it out of the drippings, thus allowing better heat circulation for even cooking. As the

fat on top of the roast melts, the meat is basted naturally, eliminating the need for additional basting.

The cooking time is determined by the weight of the meat and the desired doneness. For more accurate results, use a meat thermometer. Insert it so the tip is in the center of the thickest part of the meat. It should not touch fat or bone.

Remove the roast from the oven when the thermometer registers the desired doneness.

**NOTE:** For more information about food safety, call USDA's Meat & Poultry Hotline at 1-800-535-4555. For cooking information write to the National Live Stock and Meat Board, 444 North Michigan Avenue, Chicago, Illinois 60611.

## BROILING TIPS, if equipped

Broiling is a method of cooking tender meats by direct radiant heat. The cooking time is determined by the distance between the meat and the oven burner, the desired degree of doneness and the thickness of the meat.

Broiling requires the use of the broiler pan and insert. The broiler insert must be in place to allow fat and liquid to drain to the pan below to prevent spatters, smoke and flare-ups. Improper use may cause grease fires.

For easier clean up, line the broiler pan with foil and spray the insert with a non-stick vegetable spray. Do not cover the broiler insert with aluminum foil as this prevents fat from draining into pan below.

Trim excess fat and slash remaining fat to help keep meat from curling and to reduce smoking and splattering. Season meat after cooking.

Place the broiler rack in the correct rack position when the broiling compartment is cool. For darker browning, place meat closer to the oven burner. Place meat further down if you wish meat to be well done or if excessive smoking or flaring occurs.

See Care and Cleaning Chart on page 15 for instructions on cleaning the broiler pan and insert.

## How To Set Oven To Broil:

1. Place the broiler rack with the broiler pan in the recommended position shown in the broiling chart below. Remove broiler rack when using bottom position.

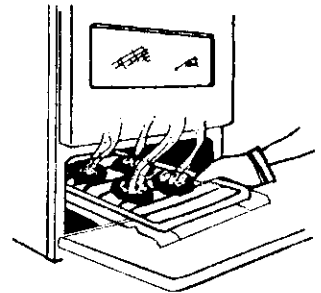

If the bottom position is selected, use mitts and carefully remove the broiler pan from the broiling compartment.

2. Push in and turn the Thermostat knob to BROIL.

It is possible to broil longer cooking foods such as chicken at a lower temperature to prevent overbrowning and reduce splattering. Turn the knob to 400° or 450°F, rather than BROIL, for low temperature broiling.

3. Follow the suggested times in the broiling chart. Meat should be turned once about halfway through cooking.
4. Check the doneness by cutting a slit in the meat near the center to check the color.
5. After broiling, turn the oven off. Pull the broil rack out and remove the broiler pan. Store the clean broiler pan and insert in the broiling compartment.

## BROIL CHART FOR BROILING COMPARTMENT

TYPE OF FOOD	DONENESS	BROILING RACK POSITION*	TOTAL TIME
<b>BACON</b>	Well Done	Middle	BROIL at 400°F 7 to 10 minutes
<b>BEEF STEAKS</b> 1-inch thick	Medium Well Done	Middle Middle	BROIL 14 to 20 minutes BROIL 16 to 24 minutes
<b>CHICKEN</b> Pieces	Well Done	Middle	BROIL at 400°F 30 to 45 minutes
<b>FISH</b> Fillets Steaks, 1-inch thick	Flaky Flaky	Middle Middle	BROIL 8 to 12 minutes BROIL 10 to 15 minutes
<b>GROUND BEEF PATTIES</b> 3/4-inch thick	Well Done	Middle	BROIL 14 to 18 minutes
<b>HAM SLICE, precooked</b> 1/2-inch thick	Warm	Middle	BROIL 8 to 12 minutes
<b>PORK CHOPS</b> 1-inch thick	Well Done •	Middle	BROIL 18 to 25 minutes

\* **Upper** is the top rack position; **middle** is the lower rack position; **bottom** is the bottom of the broiler compartment.

## COOKTOP

To prevent staining or discoloration, clean cooktop after each use. Wipe acid or sugar stains as soon as the cooktop has cooled as these stains may discolor or etch the porcelain.

The **sealed** burner cooktop is designed with two contour wells to catch and contain spills. Because of this design it is not necessary to lift up the cooktop to clean underneath. To prevent damage to the gas tubing or cooktop, **do not attempt to lift or remove the cooktop.**

The cooktop featuring **conventional** surface burners lifts up for easy cleaning of the burner box area.

**To raise the “lift-up” cooktop:** When cool, grasp the front edge of the cooktop and gently lift up until the two support rods, if equipped, at the front of the cooktop snap into place.

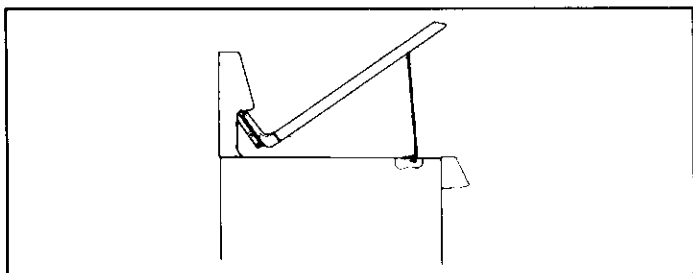

**To lower the top:** Hold the front edge of the cooktop and carefully push back on each support rod, if equipped, to release the notched support. Then gently lower the top into place. The support rods will slide into the cooktop frame.

## BURNER GRATES

Burner grates must be properly positioned before cooking. Burner grates are durable but may gradually lose their shine due to usage and high temperatures.

When installing square grates, place indented sides together so straight sides are at the front and rear. Improper installation of the grates may result in damage or chipping of the cooktop.

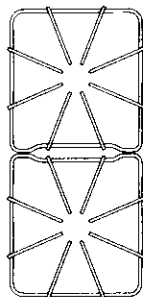

**CAUTION:** Do not operate a surface burner without a pan on the grate. The porcelain finish on the grate may chip without a pan to absorb the intense heat from the burner flame.

## CONVENTIONAL SURFACE BURNERS, if equipped

Under no circumstances are the surface burner assemblies to be taken apart for cleaning. The surface burner assembly can be removed to clean the burner box area.

The two surface burner assemblies are secured in place during transportation with screws. Once the range is installed, these screws may be removed to allow quick and easy removal of the burner assemblies.

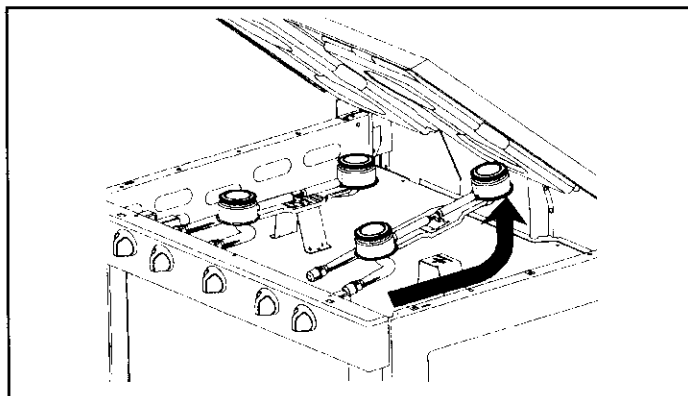

**To remove:** Allow the burner assembly to cool. Lift up cooktop. Grasp the burner assembly and rotate it slightly toward the left to release the two tabs on the assembly. Then lift the assembly and pull toward the back of the cooktop until the air shutter ends on the assembly release from the valves.

**To replace:** Insert the air shutter ends on the burner assembly over the valves and lower the assembly into place. Be sure to secure the two tabs on the burner assembly into the two slots on the burner support bracket which is mounted to the burner box bottom. (**NOTE:** If the tabs are not properly inserted into the slots, the assembly may rock and the burners may not light properly.)

## SEALED SURFACE BURNERS, if equipped

The porcelain on the burner is durable but may gradually lose its shine due to usage and high temperatures.

The sealed surface burners are secured to the cooktop and are NOT designed to be removed by the consumer,

Select models feature two special SUPER HIGH SPEED sealed burners located at the right-front and left-rear. Use these burners to quickly bring water to a boil and when using larger pans. See information on rating plate, located on the lower range front frame behind the broiler door or lower panel, to determine if your appliance features these burners.

Clean burner cap after each use especially if a spillover occurs. A soiled burner may result in improper ignition or an uneven flame. When cleaning the sealed surface burner, use care to prevent damage to the ignitor. If a cleaning cloth should catch the ignitor, it could be damaged or broken.

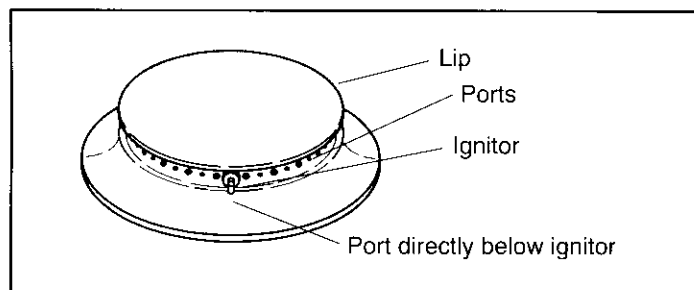

The surface burner will not light if the ignitor is damaged, broken, soiled or wet. The burner will also not light if the ports, especially the small port located directly below the ignitor, are blocked. See page 16 for cleaning instructions.

## PROPORTIONAL VALVE ADJUSTMENT

Proportional valves have an adjusting screw located inside the valve stem. Valves that do not have this screw can not be adjusted.

The LO setting should produce a stable flame when turning the knob from HI to LO. On **conventional** surface burners, the flame should be 1/8-inch tall or lower and must be stable on all ports on LO setting. For **sealed** surface burners, the flame should extend to the outer edge of the lip on the burner cap on the LO setting.

**To adjust:** Operate burner on HI for about 5 minutes to preheat the burner cap. Turn the knob back to LO; remove knob, and insert a small screwdriver into the center of the valve stem. Adjust the flame size by turning the adjustment screw in either direction.

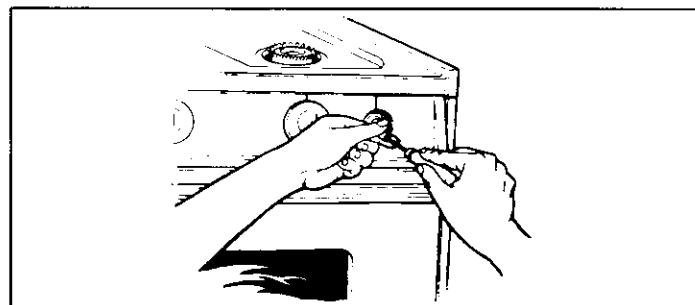

The flame must be of sufficient size to be stable on all burner ports. If the flame adjustment is needed, adjust **ONLY** on the LO setting. Never adjust flame size on a higher setting.

## LEVELING LEGS

Some floors are not level. For proper baking, your range must be level. Leveling legs are located on each corner at the base of the range. Level by turning the legs.

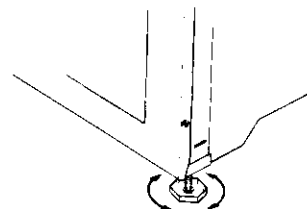

To prevent range from accidentally tipping, range should be secured to the floor by sliding a rear leveling leg into the anti-tip bracket supplied with the range.

## OVEN DOOR

Do not place excessive weight on an open oven door or stand on an open oven door as, in some cases, it could cause the range to tip over, break the door or cause serious injury to the user.

When opening the oven door, allow steam and hot air to escape before reaching into the oven to check, add or remove food.

Do not attempt to open or close the door until the door is completely seated on the hinge arms. Never turn on the oven unless the door is properly in place. When baking, be certain the door is completely closed. Baking results will be affected if the door is not securely closed.

**CAUTION:** Hinge arms are spring mounted and will slam shut against the range if accidentally hit. **Never place hand or fingers between the hinges and the front oven frame.** You could be injured if hinge snaps back.

**To remove lift-off door:** When the door is cool, open the door to the "stop" position (opened about 6 inches) and grasp the door at each side. Do not use the door handle to lift the door. Lift up evenly until the door clears the hinge arms.

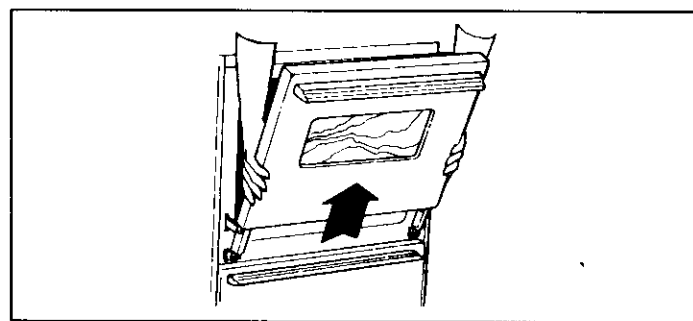

**To replace door:** Grasp the door at each side, align the slots in the door with the hinge arms and slide the door down onto the hinge arms until it is completely seated on the hinges.

**OVEN BOTTOM**

Protect the oven bottom against excessive spillovers, especially acid or sugary spillovers, as they may discolor the porcelain. Use the correct size cooking utensil to avoid boilovers. Never place utensils or aluminum foil directly on the oven bottom.

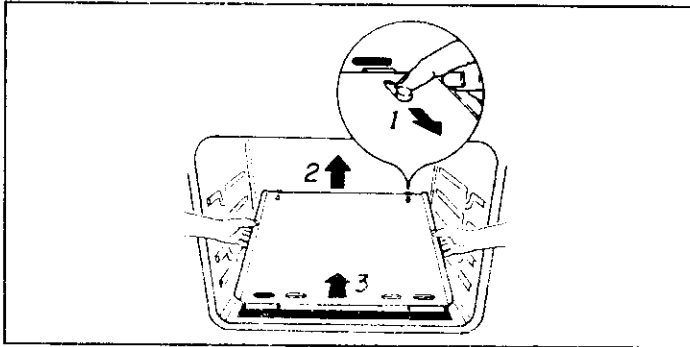

**To remove:** When cool, remove the oven racks. Slide the two catches, located at each rear corner of the oven bottom, toward the front of the oven. Lift the rear edge of the oven bottom slightly. Then slide it back until the front edge of the oven bottom clears the oven front frame. Remove the oven bottom from the oven.

**To replace:** Fit the front edge of the oven bottom into the front frame. Lower the rear of the oven bottom and slide the two catches back to lock the oven bottom into place.

**OVEN LIGHT**, if equipped

Before replacing the light bulb, **DISCONNECT POWER TO THE RANGE**. Be sure the bulb is cool. Do not touch a hot bulb with a damp cloth as the bulb may break.

**To turn on oven light:** Push in the rocker switch located on the backguard.

**To replace oven light:** Be sure the bulb is cool. Use a dry potholder, to prevent possible harm to hands, and very carefully unscrew bulb.

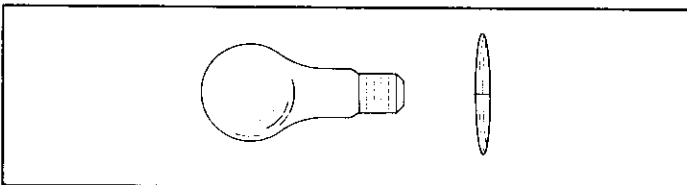

Replace with a 40 watt appliance bulb and reconnect power to the range. Reset the clock.

**LOWER PANEL**, if equipped

Ranges that are not equipped with a lower broiling compartment will have a panel in place of the broiler door. This panel must be removed to access the rating plate located on the lower range front frame. The rating plate contains the model and serial numbers for your appliance.

**To remove panel:** Grasp the bottom corners of the panel. Then lift the panel up and away from the range.

**To replace panel:** Align the four slots on the panel with the four screws on the range front frame. Then lower the panel and push down until the panel snaps into place.

**ELECTRICAL CONNECTION**

Appliances which require electrical power are equipped with a **three-prong grounding plug** which must be plugged directly into a properly grounded three-hole 120 volt electrical outlet.

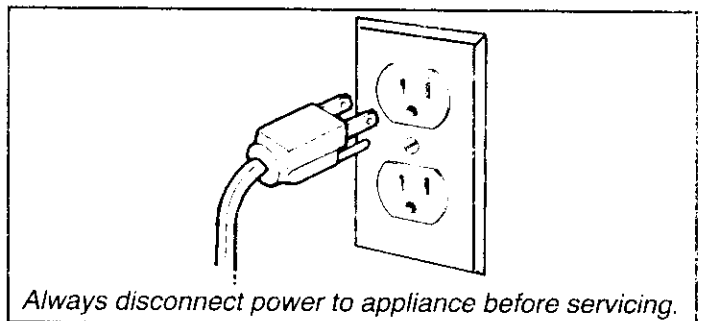

The three-prong grounding plug offers protection against shock hazards. **DO NOT CUT OR REMOVE THE THIRD GROUNDING PRONG FROM THE POWER CORD PLUG.**

If an ungrounded, two-hole or other type electrical outlet is encountered, **it is the personal responsibility of the appliance owner to have the outlet replaced with a properly grounded three-hole electrical outlet.**



## ABOUT CLEANING PRODUCTS

Because of the many new cleaning products introduced each year, it is not possible to list all products that can be safely used to clean this appliance.

READ THE MANUFACTURER'S INSTRUCTIONS to be sure the cleaner can be safely used on this appliance. Also, read and carefully follow the manufacturer's directions when using any cleaning product.

To determine if a cleaning product is safe, test a small inconspicuous area using a very light pressure to see if the surface may scratch or discolor. This is particularly important for porcelain enamel, metal, plastic or highly polished, shiny, or painted surfaces.

The following brands may help you make an appropriate selection:

**Glass Cleaners** – Bon Ami, Cinch, Glass Plus, Windex.

**Dishwashing Liquid Detergents** – Dawn, Dove, Ivory, Joy.

**Mild Liquid Spray Cleaners** – Fantastik, Formula 409.

**Non-Abrasive Cleaners** – Bon Ami, paste of baking soda and water.

**Mildly Abrasive Powder or Liquid Cleansers** – Ajax, Barkeepers Friend, Cameo, Comet, Soft Scrub.

**Non-Abrasive or Scratchless Plastic or Nylon Scouring Pads or Sponges** – Chore Boy Plastic Cleaning Puff, Scrunge Scrub Sponges, or Scotch-Brite No Scratch, Cookware or Kitchen Sponge.

**Abrasive Scouring Pads** – S.O.S., Brillo Steel Wool Soap, or Scotch-Brite Wool Soap Pads.

*(Brand names for the above cleaning products are registered trademarks of the respective manufacturers.)*

Be sure appliance is off and all parts are cool before handling or cleaning to avoid damage and possible burns. If a part is removed, be sure it is correctly replaced.

To prevent staining or discoloration, clean range after each use.

## CARE AND CLEANING CHART

PARTS	CLEANING AGENTS	DIRECTIONS
<b>Baked enamel or painted</b> • Backguard panels • Broiler door • Oven door • Range front frame behind broiler door • Side panels	<ul style="list-style-type: none"> <li>• Soap and water</li> <li>• Mild liquid cleaner</li> <li>• Glass cleaner</li> </ul>	Use a dry towel or cloth to wipe up spills, especially acid (milk, lemon juice, fruit, mustard, tomato sauce) or sugary spills. Surface may discolor or dull if soil is not immediately removed. This is especially important for white surfaces.  When surface is cool, wash with warm soapy water, rinse and dry. For stubborn soil, use non-abrasive cleaning agents such as baking soda paste or Bon Ami. If desired, a thin coat of mild appliance wax can be used to protect the side panels. A glass cleaner can be used to add "shine" to the surface.  <b>NOTE:</b> Do not use abrasive, caustic or harsh cleaning agents such as steel wool pads or oven cleaners. These products will scratch or permanently damage the surface.  <b>NOTE:</b> Never wipe a warm or hot surface with a damp cloth as this may damage the surface and may cause a steam burn.
<b>Broiler pan and insert</b>	<ul style="list-style-type: none"> <li>• Soap and water</li> <li>• Plastic scouring pad</li> <li>• Soap-filled scouring pad</li> <li>• Dishwasher</li> </ul>	Remove from broiling compartment after use. Cool then pour off grease. Place soapy cloth over insert and pan; let soak to loosen soil. Wash in warm soapy water. Use soap-filled scouring pad to remove stubborn soil. Clean in dishwasher if desired.  <b>NOTE:</b> For easier cleanup, spray insert with a non-stick vegetable coating and line broiler pan with aluminum foil.
<b>Burner box</b>	<ul style="list-style-type: none"> <li>• Soap and water</li> <li>• Paste of baking soda and water</li> <li>• Non-abrasive plastic pad or sponge</li> <li>• Liquid cleaner</li> <li>• Glass cleaner</li> </ul>	Burner box, for cooktops with conventional burners, is located under lift-up cooktop. Clean frequently to remove spillovers. If soil is not removed and is allowed to accumulate, it may damage the finish. To clean remove grates and surface burners and clean with soap and water, rinse and dry. ( <b>NOTE:</b> Sealed burner cooktop does not lift up.)
<b>Chrome drip bowls, if equipped</b>	<ul style="list-style-type: none"> <li>• Soap and water</li> <li>• Paste of baking soda and water</li> <li>• Plastic scouring pad</li> </ul>	Clean bowls after each use with soap and water. Remove stubborn stains with baking soda paste and plastic scouring pad. To prevent scratching the finish, do not use abrasive cleaning agents. Rinse, dry and replace.  <b>NOTE:</b> Bowls can permanently discolor over time or if exposed to excessive heat or if soil is allowed to bake on. The discoloration will not affect the cooking performance.
<b>Continuous clean oven, if equipped</b> • Oven cavity	Cleaning action begins whenever the oven is on. The oven must be used for cleaning to take place. Higher oven temperatures and longer baking times speed the cleaning action.	Do not use paper towels, cloths, or sponges because the oven walls are porous and particles of these materials will rub off on the walls. Brush off heavy soil with a nylon or plastic pad. Rinse area with clean water only. Do not use any type of oven cleaner, cleanser or detergent on this surface.

*(Continued next page)*

## CARE AND CLEANING CHART

PARTS	CLEANING AGENTS	DIRECTIONS
<b>Control knobs</b>	<ul style="list-style-type: none"> <li>• Soap and water</li> </ul>	To remove knobs for cleaning, gently pull forward. Wash in mild detergent and water. Do not soak knobs in water. Do not use abrasive cleaning agents. They will scratch finish and remove markings. Rinse dry and replace. <b>Turn ON each burner to see if knobs have been replaced correctly.</b>
<b>Glass</b> • Oven window	<ul style="list-style-type: none"> <li>• Soap and water</li> <li>• Paste of baking soda and water</li> <li>• Glass cleaner</li> </ul>	Wash with soap and water. Use a glass cleaner and a soft cloth after cleaning. Remove stubborn soil with paste of baking soda and water. Rinse with a cloth wrung out in clear water. Dry. Do not use abrasive materials such as scouring pads, steel wool or powdered cleaning agents. <b>NOTE:</b> To avoid inside staining of oven door glass, do not oversaturate cloth.
<b>Grates</b>	<ul style="list-style-type: none"> <li>• Soap and water</li> <li>• Non-abrasive plastic pad</li> </ul>	Grates are made of porcelain-coated steel. They can be cleaned at the sink with soap and water or in the dishwasher. To clean baked on soil, place a damp soapy paper towel over the grate and let stand for 30 minutes. Use a non-abrasive plastic pad to scour stubborn soil. <b>NOTE:</b> Never operate burner without a grate in place. To protect the porcelain finish on the grate from excessive heat, never operate surface burner without a cooking utensil on the grate. It is normal for grates to lose their shine over a period of time.
<b>Metal finishes</b> • Broiler compartment cavity • Door handles • Trim parts	<ul style="list-style-type: none"> <li>• Soap and water</li> <li>• Glass cleaner</li> <li>• Paste of baking soda and water</li> <li>• Non-abrasive plastic pad</li> </ul>	Wash with soap and water. Remove stubborn soil in broiler compartment cavity with paste of baking soda and water. Use a glass cleaner and a soft cloth to remove fingermarks or smudges on trim or handle. <b>NOTE:</b> Do not use oven cleaners, abrasive or caustic agents. They will damage the finish on trim or handle.
<b>Oven bottom</b>		Protect the porcelain enamel oven bottom by (1) using large enough cookware to prevent boilovers; (2) placing a piece of aluminum foil, that is slightly larger than the cookware, on the lower rack. <b>NEVER</b> place foil directly on the oven bottom as foil may melt onto oven bottom. Protect oven bottom against acid spills (milk, cheese, tomato, lemon juice, etc.) or sugary spills (pie filling) as they may pit or discolor the oven bottom. See porcelain enamel for additional information.
<b>Oven racks</b>	<ul style="list-style-type: none"> <li>• Soap and water</li> <li>• Cleansing powders</li> <li>• Plastic pad</li> <li>• Soap filled scouring pad</li> </ul>	Clean with soapy water. Remove stubborn soil with cleansing powder or soap filled scouring pad. Rinse and dry. <b>NOTE:</b> If racks become difficult to slide, a thin coat of vegetable oil on the underside of the rack will make sliding easier.
<b>Plastic finishes</b> • Door handles • Backguard trim • Knobs • End caps	<ul style="list-style-type: none"> <li>• Soap and water</li> <li>• Non-abrasive plastic pad or sponge</li> <li>• Glass cleaner</li> </ul>	When surface is cool, clean with soap and water; rinse, and dry. Use a glass cleaner and a soft cloth. <b>NOTE:</b> Never use oven cleaners, abrasive or caustic liquid or powdered cleansers on plastic finishes. These cleaning agents will scratch or mar finish. <b>NOTE:</b> To prevent staining or discoloration, wipe up fat, grease or acid (tomato, lemon, vinegar, milk, fruit juice, marinade) immediately with a dry paper towel or cloth.
<b>Porcelain enamel</b> • Backguard • Cooktop • Inner oven & broiler door panel • Manifold panel • Oven cavity • Oven bottom	<ul style="list-style-type: none"> <li>• Soap and water</li> <li>• Mild abrasive cleaners</li> <li>• Plastic pad</li> <li>• Oven cleaner, oven only</li> <li>• Soap filled scouring pad</li> </ul>	Clean porcelain with soap and water; rinse. Use cleansing powders or a plastic scouring pad to remove stubborn soil. Wipe acid or sugar stains as soon as area is cool as these stains may discolor or etch the porcelain. Do not use metallic scouring pads as they will scratch the porcelain.  To make cleaning the oven easier, place 1/2 cup household ammonia in a shallow glass container and leave in a cold oven overnight. The ammonia fumes will help loosen the burned on grease and food. Oven cleaners can be used on the porcelain oven only. Follow manufacturer's directions. If oven cleaner was used, thoroughly rinse oven cavity and capillary tube which is located at the top of the oven.
<b>Silicone rubber</b> • Door gasket	<ul style="list-style-type: none"> <li>• Soap and water</li> </ul>	Wash with soap and water, rinse and dry. Do not remove door gasket.
<b>Surface burners</b> • Conventional • Sealed	<ul style="list-style-type: none"> <li>• Soap and water</li> <li>• Paste of baking soda and water</li> <li>• Plastic scouring sponge or pad</li> <li>• Mildly abrasive cleanser</li> </ul>	<b>All burners:</b> For ease of cleaning, clean burners each time the cooktop is used with warm soapy water. If a boilover occurs, remove pan to another burner; cool burner and clean. To remove stubborn soil, use a dry cloth and mildly abrasive cleanser. Use care to prevent cleaner from clogging ports. Burner must be dry before use. <b>NOTE:</b> Yellow tipping or distortion of the flame may occur until the burner is completely dry.  Clean <b>burner ports</b> with a straight pin or small metal paper clip. Do not enlarge or distort ports. Do not use a wooden toothpick as it may break off and clog port. If ports are clogged or soiled, the burner may not light properly or the flame may not be even.  <b>Conventional burners:</b> Dry burners in the oven set at 170°F.  <b>Sealed burners:</b> Sealed burner can not be removed by the consumer. When cleaning burner, use care to prevent damage to the ignitor. Surface burner will not light properly if ignitor is damaged, broken, soiled, or wet. When cleaning the ports, be sure to clean the port directly below the ignitor.

## HOW TO REMOVE RANGE FOR CLEANING AND SERVICING

Follow these procedures to remove appliance for cleaning or servicing:

1. Shut-off gas supply to the appliance.
2. Disconnect electrical supply to the appliance, if equipped.
3. Disconnect gas supply tubing to the appliance.
4. Slide range forward to disengage range from the anti-tip bracket. See the Installation Instructions for location of the bracket.
5. Reverse procedure to reinstall. If gas line has been disconnected, check for gas leaks after reconnection. A qualified servicer should disconnect and reconnect the gas supply. See the Installation Instructions for gas leak test method.

To prevent range from accidentally tipping, range must be secured to the floor by sliding rear leveling leg into an anti-tip bracket supplied with the range.

**WARNING:** Possible risks may result from abnormal usage, including excessive loading of the oven door and of the risk of tip over, should the appliance not be reinstalled according to the installation instructions.

## HOW TO OBTAIN SERVICE

**Do not attempt to service the appliance yourself unless directed to do so in this manual. Contact the dealer who sold you the appliance for service or call us. Our telephone number is found on the separate warranty sheet.**

If your appliance should require service or replacement parts, contact your dealer or authorized servicer. Be sure to have the model and serial numbers of the appliance available. See the front cover of this manual for location of these numbers. Please review the separate warranty sheet that comes with your appliance to see if the service you are requesting is covered by the warranty.

If you are not satisfied with the local response to your service requirements, write to Maytag Customer Service, P.O. Box 2370, Cleveland, TN 37320-2370. Include your name, address, phone number, the complete model and serial numbers of the appliance, the name and address of the dealer from whom you purchased the appliance, the date of purchase and details concerning your problem.

If you do not receive satisfactory service, you may contact the Major Appliance Consumer Action Program by letter. Include the information listed above.

Major Appliance Consumer Action Program  
20 North Wacker Drive  
Chicago, IL 60606

MACAP (Major Appliance Consumer Action Program) is an independent agency sponsored by three trade associations as a court of appeals on consumer complaints which have not been resolved satisfactorily within a reasonable period of time.

## CHECK THESE POINTS BEFORE YOU CALL FOR SERVICE

PROBLEM	CAUSE	CORRECTION
Surface burner fails to light.	a. power supply not connected. b. clogged burner port(s). c. surface control not completely turned to the LITE position or turned too quickly from the LITE position. d. power failure (pilotless ignition). e. on sealed burner models: Burner will not light if the ignitor is damaged, soiled, wet or if the port directly below the ignitor is blocked. f. burner assembly incorrectly installed.	a. connect power, check circuit breaker or fuse box. b. clean ports with straight pin or small paper clip. See page 16 for cleaning instructions. c. turn control to the LITE position until the burner ignites, then turn control to desired flame size. d. see page 5 to light burner during a power failure. e. clean and dry burner head. If broken or damaged, call a serviceman. f. see page 12.
Burner flame is uneven.	a. clogged burner port(s).	a. clean ports with straight pin.

*(Continued next page)*

## CHECK THESE POINTS BEFORE YOU CALL FOR SERVICE

PROBLEM	CAUSE	CORRECTION
Surface burner flame lifts off port or is yellow in color.	a. air/gas mixture not proper. b. no pan in place.  NOTE: Lifting of flame is normal for sealed burners. Some yellow tipping with LP gas is normal and acceptable.	a. call serviceman to adjust burner. b. always place pan on grate before lighting burner.  NOTE: Be sure installer properly adjusted range at time of installation.
Surface burner ignitor producing clicking sound.	a. control knob is in the LITE position. NOTE: The life of the ignition system may be shortened if the knob is left in the LITE position. b. surface control switch is moist as a result of cleaning the range. c. malfunctioning switch.	a. be sure ALL surface burner control knobs are in the OFF position or are adjusted to the desired flame setting.  b. allow switch to dry then relight burner.  c. call serviceman to check.
Oven burner fails to light.	a. power supply not connected. b. power failure. c. oven incorrectly set.	a. connect power, check circuit breaker or fuse box. b. oven will not operate during a power failure. c. See page 7.
Popping sound heard when burner extinguishes.	This is a normal sound that occurs with some types of gas when a hot burner is turned off. The popping sound is not a safety hazard and will not damage the appliance.	
Clock and/or oven light does not work.	a. power supply not connected. b. bulb may be loose or burned out. c. malfunctioning switch, starter or ballast. d. malfunctioning clock or loose wiring.	a. connect power supply, check circuit breaker or fuse box. b. tighten or replace light bulb. c. call serviceman to check. d. call serviceman to check.
Moisture condensation on oven window, if equipped, when oven is in use.	a. it is normal for the window to fog during the first few minutes the oven is on. b. cloth saturated with water is used to clean the window.	a. leave door ajar for one or two minutes to allow moisture to escape. b. use a damp cloth to clean window to prevent excess water from seeping between the panels of glass.
<b>Baking results are not satisfactory.</b> <ul style="list-style-type: none"> <li>• browning is too pale, too dark or is uneven.</li> <li>• food cooks unevenly.</li> <li>• food is underdone or overdone.</li> </ul>	a. oven not preheated or set at correct temperature. b. used incorrect rack position c. incorrect use of aluminum foil d. oven bottom incorrectly replaced e. oven thermostat sensing device is out of the holding clip(s).	a. preheat oven 10 to 15 minutes  b. see page 7 c. see page 8 d. replace oven bottom correctly e. reinstall thermostat sensing device See Problem Chart on page 9 for additional information
Oven smokes excessively during a broil operation.	a. food too close to burner b. meat has too much fat c. sauce applied too early or marinade not completely drained  d. soiled broiler pan  e. broiler insert covered with aluminum foil  f. broiling compartment bottom is soiled	a. move broiler pan down one rack position b. trim fat c. apply sauce during last few minutes of cooking. If meat has been marinated, drain thoroughly before cooking d. always clean broiler pan and insert after each use e. never cover insert with foil as this prevents fat from draining to pan below f. clean broiling compartment