

Whirlpool 27-INCH BUILT-IN SELF-CLEANING &
CONTINUOUS-CLEANING
ELECTRIC OVENS Model RB170PXL

use & care guide

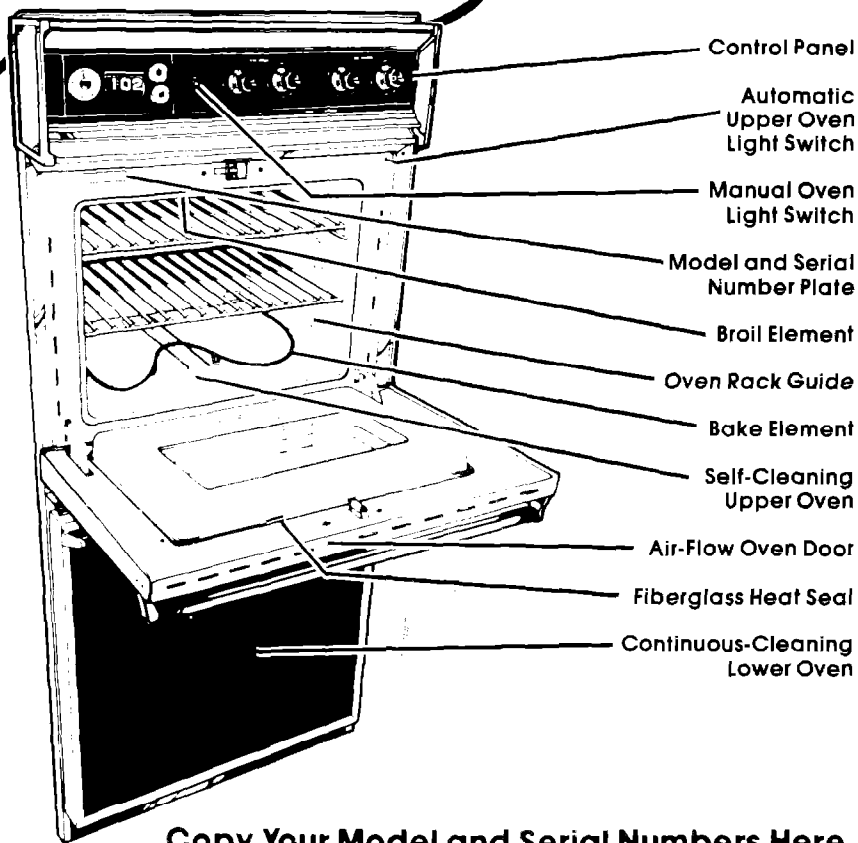

Copy Your Model and Serial Numbers Here

If you need service, or call with a question, have this information ready.

1. **Complete** Model and Serial Numbers (from the plate just behind the upper oven door)
2. Purchase date from your sales slip

Copy this information in these spaces. Keep this book, your warranty and the sales slip together in a handy place

.....
Model Number

.....
Serial Number

.....
Purchase Date

.....
Service Company and Phone Number

See the "Cooking Guide" for important safety information.

Your responsibilities...

Proper installation and safe use of the oven are your personal responsibilities. Read this "Use and Care Guide" and the "Cooking Guide" carefully for important use and safety information.

Installation

You must be sure your oven is...

- installed and leveled in a wall or cabinet that will hold the weight;
- installed in a well-ventilated area protected from the weather;
- properly connected to the correct electric supply and grounding. (See "Installation Instructions.")

Proper use

You must be sure your oven is...

- used only for jobs expected of home ovens;
- used only by people who can operate it properly;
- properly maintained.

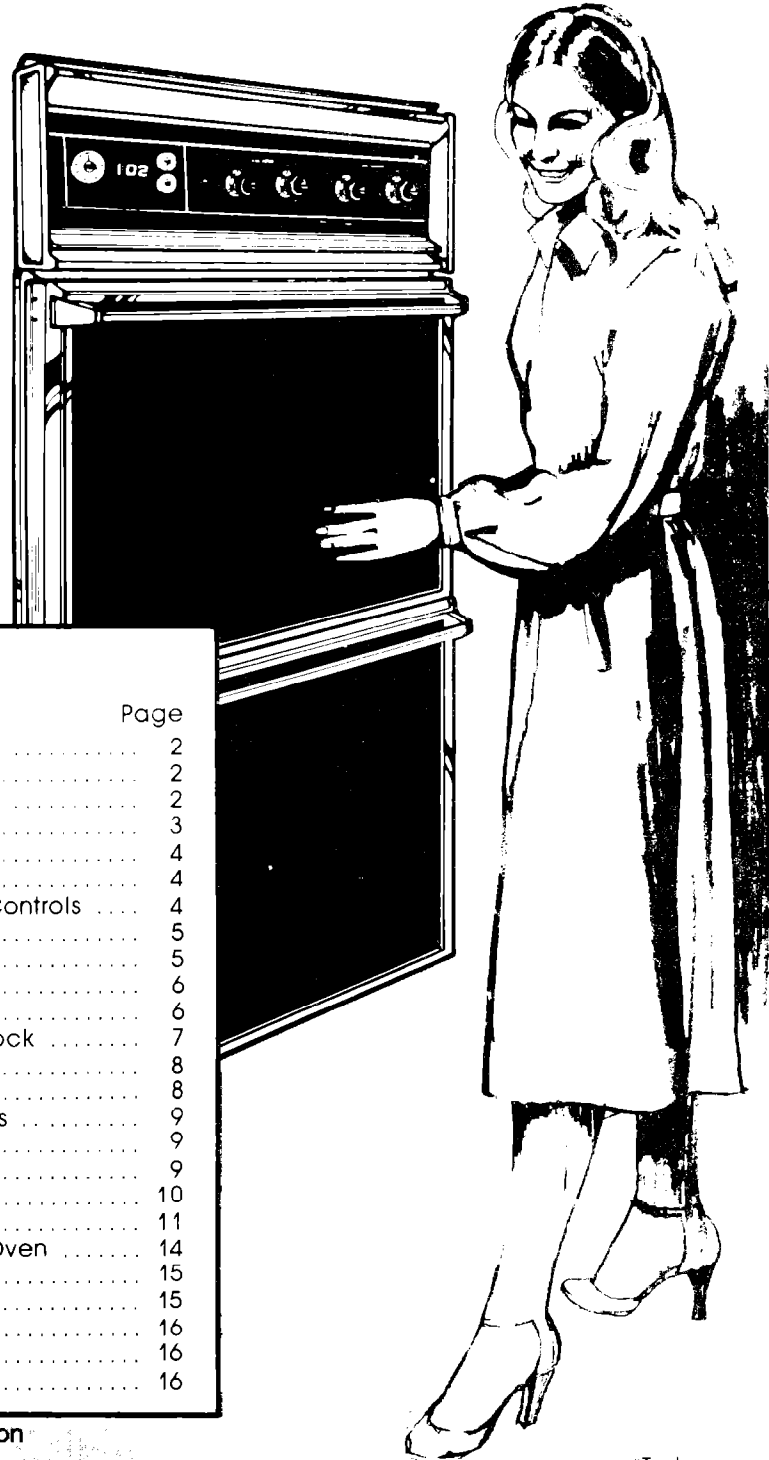

Contents

	Page
Your Responsibilities	2
Installation	2
Proper Use	2
Safety	3
Using Your Ovens	4
Baking in Either Oven	4
Adjusting the Oven Temperature Controls	4
Broiling in Either Oven	5
Oven Rack Positions	5
Setting the Clock	6
Using the Minute Timer	6
Using the Automatic MEALTIMER® Clock	7
Oven Lights	8
Oven Vents	8
Cleaning and Caring For Your Ovens	9
Control Panel and Knobs	9
Cleaning Chart	9
The Lower Oven Door	10
The Self-Cleaning Upper Oven	11
The Continuous-Cleaning Lower Oven	14
If You Need Service or Assistance	15
1. Before Calling for Assistance	15
2. If You Need Assistance	16
3. If You Need Service	16
4. If You Have a Problem	16

©1986 Whirlpool Corporation

*Tmk

Safety

Remove Consumer Buy Guide Label before using your oven.

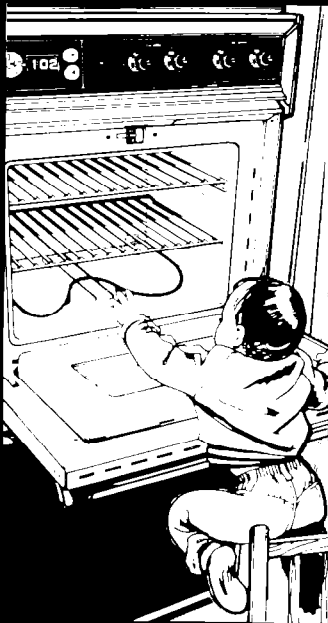

DO NOT allow children to use or play with the oven.

DO NOT store things children might want above the oven. *Too much weight on an open oven door can damage the door.*

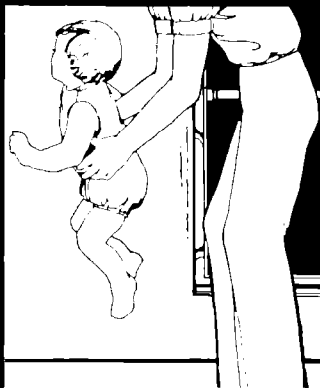

KEEP children away from the oven when it is ON. The oven frame walls, racks and door can get hot enough to cause burns.

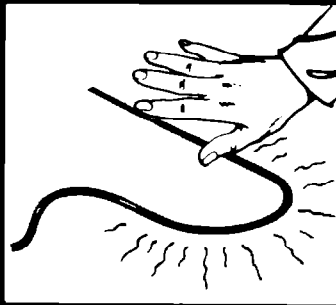

• Don't touch any part of the oven, especially heating elements, until you know they are completely cool.

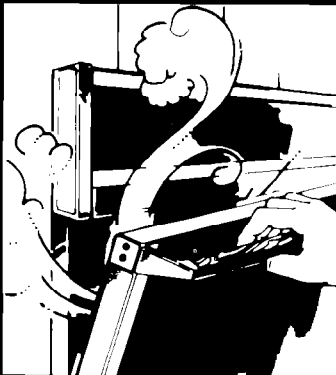

Let steam and hot air escape from the oven before moving food.

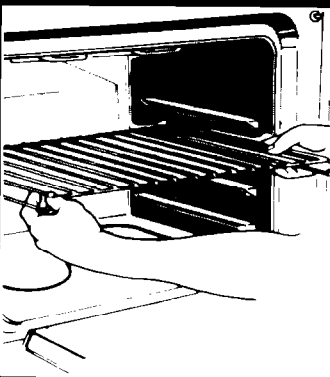

• Put oven racks where you want them before turning on the oven.



• **DO NOT** use wet pot-holders. They can cause steam burns.
• **DO NOT** wear loose clothing while using the oven, or use bulky towels or cloths for potholders. They can catch fire if they touch a hot element.

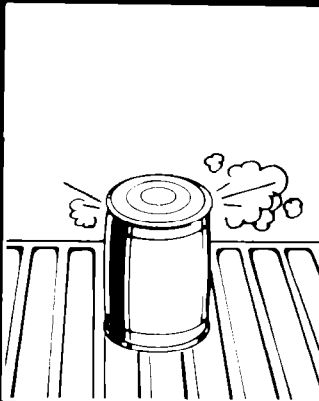

DO NOT heat unopened containers. They can explode.

• **FOR YOUR SAFETY** •

DO NOT STORE OR USE GASOLINE OR OTHER FLAMMABLE VAPORS AND LIQUIDS IN THE VICINITY OF THIS OR ANY OTHER APPLIANCE.

Using your ovens

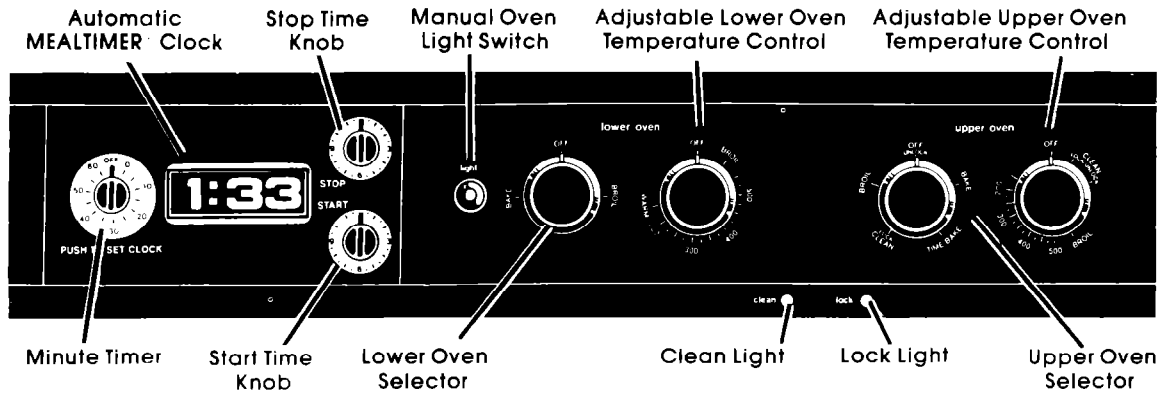

SETTING THE CONTROLS

BAKING IN EITHER OVEN

1. Put oven racks where you want them (See page 5 for suggestions.)
2. Set Oven Selector to BAKE.
3. Set Oven Temperature Control to the baking temperature you want.
4. Let the oven preheat until the Signal Light goes off.
5. Put food in the oven.
6. When done baking, turn both knobs to OFF.

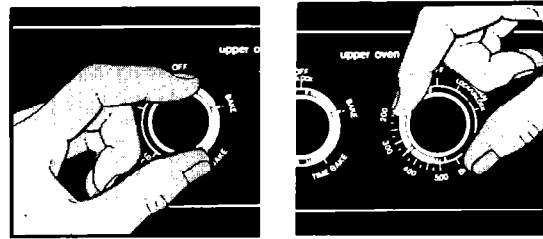

During baking, the elements will turn on and off to help hold the oven temperature at the setting. (The top element will never turn red, but will be hot.) The Signal Light will turn on and off with the elements.

ADJUSTING THE OVEN TEMPERATURE CONTROLS

Does either oven seem to be hotter or colder than your old oven at the same settings? The temperature setting in your old oven may have changed gradually over the years. The accurate setting of your new ovens can seem different. If you think either or both oven temperatures need adjusting, follow these steps

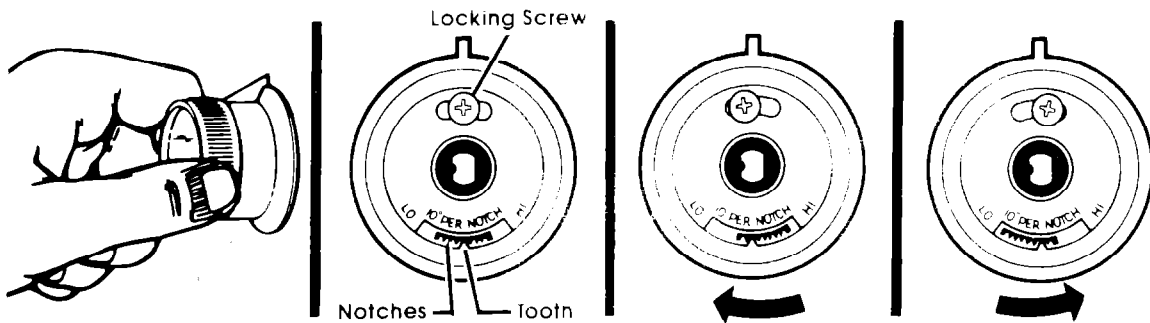

1. Pull the Oven Temperature Control straight off.
2. Loosen the locking screw; NOTICE position of notches.
3. To lower the temperature, move a notch closer to LO. Each notch equals about 10°F (5°C).
4. To raise the temperature, move a notch closer to HI. Each notch equals about 10°F (5°C).

Tighten the locking screw. Replace the knob.

BROILING IN EITHER OVEN

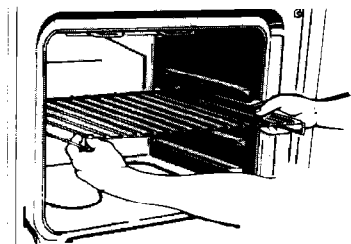

1. Place the rack where you want it for broiling (See below for suggestions.)

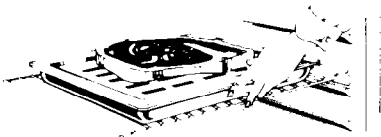

2. Put broiler pan and food on the rack.

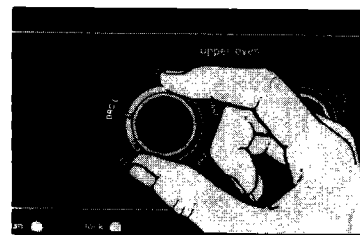

3. Set Oven Selector to BROIL.

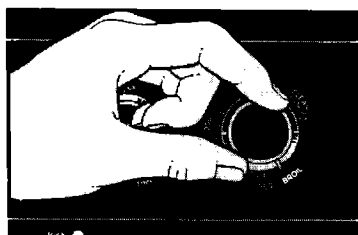

4. Set Oven Temperature Control to BROIL. (Set on a lower temperature for slower broiling. See below.)

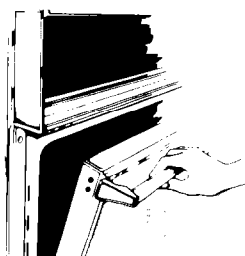

5. During broiling the oven door must be partly open. A built-in stop will hold it there.

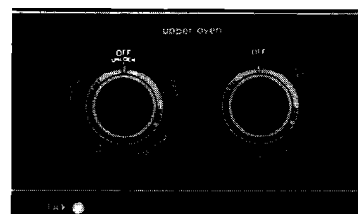

6. When broiling is done, turn both knobs to OFF.

Broiling can be slowed by setting the Oven Temperature Control to a setting lower than BROIL. When it's on BROIL, the broil element is on all the time. When it's on a temperature, the element turns off and on. The lower the setting, the shorter the times when the element is on.

The Oven Selector must be on BROIL and the door partly open for all broiling temperatures.

OVEN RACK POSITIONS

Position racks before turning on the oven.

There are two racks in the upper oven and one rack in the lower oven. The racks can be used in either oven.

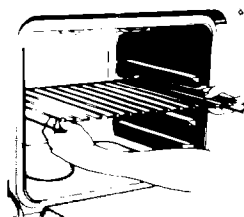

Lift rack at front and pull out.

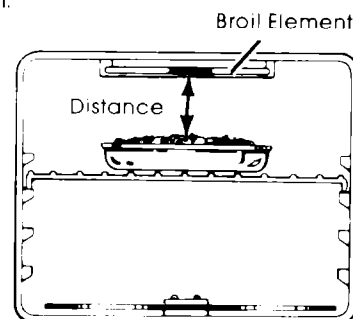
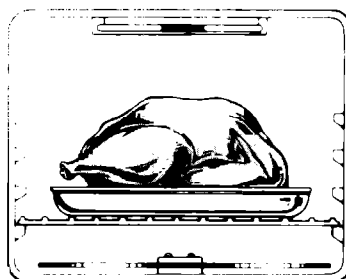

BAKING OR ROASTING

Food for baking or roasting should be placed in the center of the oven.

Always leave at least 1½ to 2 inches (4-5 cm) between the sides of a pan and the oven wall and another pan. For more information, see the "Cooking Guide."

BROILING

Adjust the top rack so the food to be broiled is at a suggested distance from the broil element, (see page 6). ALWAYS broil with the door open to the broil-stop.

Suggested oven-rack positions and broiling times



Food	Description	Inches (cm) from top of food to Broil Element	Approximate Minutes – Selector set to BROIL	
			1st side	2nd side
Beef Steaks				
Rare	1 (2.5 cm)	3 (8 cm)	7-9	3-5
Medium	1 (2.5 cm)	3 (8 cm)	9-11	4-7
Well done	1 (2.5 cm)	3 (8 cm)	11-13	5-7
Beef Steaks				
Rare	1½ (4 cm)	4-5 (10-13 cm)	13-15	6-8
Medium	1½ (4 cm)	4-5 (10-13 cm)	17-19	8-10
Well Done	1½ (4 cm)	4-5 (10-13 cm)	19-21	14-16
Hamburgers	½ (1 cm)	3 (8 cm)	6-8	4-5
Lamb Chops				
Medium	1 (2.5 cm)	3 (8 cm)	6-8	4-5
Ham slice, precooked or tendered	½ -1 (1-2.5 cm)	3 (8 cm)	6-8	4-5
Canadian Bacon	½ (1 cm)	3 (8 cm)	6	4
Pork Rib or Loin Chop				
Well done	¾ -1 (2-2.5 cm)	4-5 (10-13 cm)	15	10
Chicken	2-3 lb. (1-1.5 kg) cut in half	7-9 (18-23 cm)	25-30	10-12
Fish				
whole		3 (8 cm)	11-16	9-14
fillets		3 (8 cm)	7-8	5-7
Liver	½ -¾ (1-2 cm)	3 (8 cm)	3	3
Frankfurters		4-5 (10-13 cm)	6-7	4-5

SETTING THE CLOCK

Push in and turn the Minute Timer Knob to set the Clock



1. Push in Minute Timer Knob and turn **clockwise** until clock shows the right time of day.



2. Let the Minute Timer Knob pop out. Turn counterclockwise until the Minute Timer dial shows OFF. **The clock setting will change if you push in when turning.**

USING THE MINUTE TIMER

DO NOT PUSH IN THE KNOB when setting the Minute Timer.



1. **Without pushing it in**, turn the Minute Timer Knob until the hand passes the setting you want

PUSHING IN AND TURNING THE KNOB CHANGES THE CLOCK SETTING.

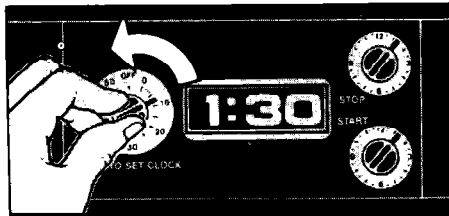

2. **Without pushing in**, turn the knob back to the setting you want.
3. When the time is up, a buzzer will sound. To stop the buzzer, turn the dial to OFF **without pushing in the knob.**

USING THE AUTOMATIC MEALTIMER* CLOCK

The Automatic MEALTIMER Clock is designed to turn the **upper oven** on and off at times you set, even when you are not around. **IMPORTANT:** Follow these steps **in order**.

To start and stop baking automatically:

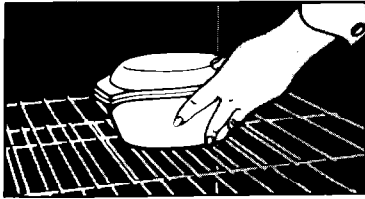

1. Put the racks where you want them and place the food in the oven.

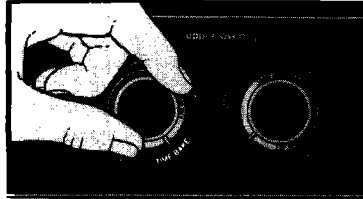

2. Set the Oven Selector on TIMED BAKE.

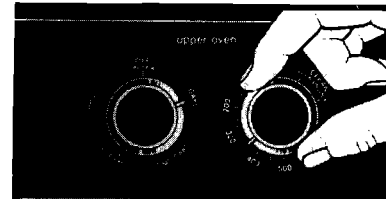

3. Set the Oven Temperature Control on the baking temperature you want.

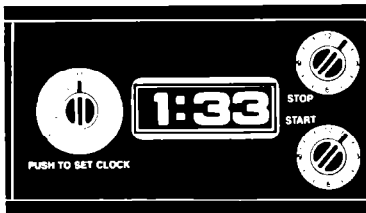

4. Make sure the clock is set to the right time of day.

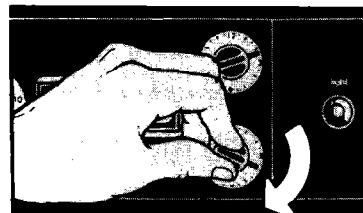

5. Push in and turn the Start Time Knob **clockwise** to the time you want baking to start.

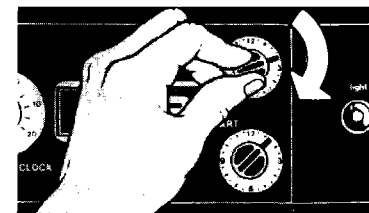

6. Push in and turn the Stop Time Knob **clockwise** to the time you want the oven to shut off.

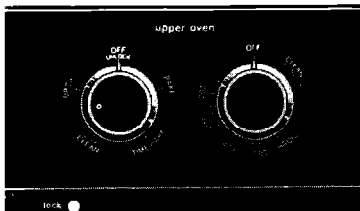

7. After baking is done, turn both knobs to OFF.

8. To stop the oven before the preset time, turn both knobs to OFF.

To stop baking automatically:

1. Put the racks where you want them and place the food in the oven.
2. Set the Oven Selector on TIMED BAKE.
3. Set the Oven Temperature Control on the baking temperature you want.
4. Make sure the clock is set to the right time of day.

5. Push in and turn the Stop Time Knob **clockwise** to the time you want the oven to shut off.
6. After baking is done, turn both knobs to OFF.
7. To stop the oven before the preset time, turn both knobs to OFF.

SPECIAL CAUTION:

Use foods that will not go bad or spoil while waiting for cooking to start. Avoid using dishes with milk or eggs, cream soups, cooked meats or fish, or any item with baking powder or yeast.

Smoked or frozen meats may be used, so can vegetables, fruits and casserole-type foods. Vegetables can be cooked in

a covered baking dish with about a half-cup (118 mL) of water for 1 to 1½ hours.

Any food that has to wait for cooking to start should be very cold or frozen before it is put in the oven. **MOST UNFROZEN FOODS SHOULD NEVER STAND MORE THAN TWO HOURS BEFORE COOKING STARTS**

If the steps for using the Automatic MEALTIMER* Clock are not followed in order, the electric oven door lock may be turned on. The door will then either:

- not open;
- not close all the way (the oven light stays on).

If the Door Won't Open:

1. Make sure the Clock, Start and Stop Times are set to the right time of day.
2. Turn the Oven Selector and Oven Temperature Control to CLEAN.
3. Push in and turn the Stop Time Knob **past** the right time of day.
4. **Wait 30 seconds.**
5. Turn the Oven Selector to OFF and leave the Oven Temperature Control at CLEAN. The door will be unlocked within 10 seconds.

If the Door won't Close:

1. Make sure the Clock, Start and Stop Times are set to the right time of day; open the oven door.
2. Turn the Oven Selector and Oven Temperature Control to CLEAN.
3. Push in and turn the Stop Time Knob **past** the right time of day.
4. Push the automatic light switch in and hold it in for 10 seconds.
5. Let the oven switch go, turn the Oven Selector to OFF, and leave the Oven Temperature Control at CLEAN.
6. Push in the automatic oven light switch and hold it for another 10 seconds.
7. Close the oven door.

*Tmk

THE OVEN LIGHTS

Both oven lights will come on when you push the **Light Switch**. Push the switch again to shut them off. Both lights will also come on when the upper oven door is opened.

To replace the upper or lower oven light bulb:

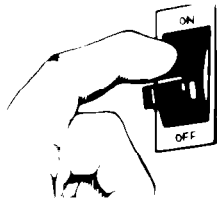

1. Turn off the electric power at the main power supply

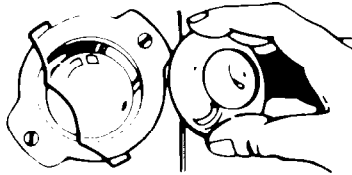

2. Remove the bulb cover by pulling out on the wire holder and moving it to the side

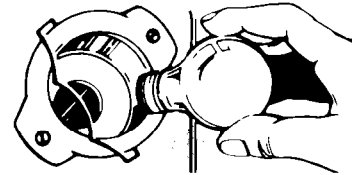

3. Remove the light bulb from its socket.

4. Replace the bulb with a 40-watt **appliance** bulb available from most grocery, variety and hardware stores

5. Replace the bulb cover and snap the wire holder in place. **The bulb must have this cover when the oven is being used.**

6. Turn electrical power back on at main power supply.

THE OVEN VENTS

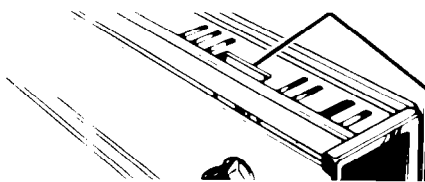

When the oven is on, hot air and moisture escape through a vent on top of the control panel. These vents are needed for air circulation.

Do not block the vents. Poor baking can result.

Cleaning and caring for your ovens

CONTROL PANEL AND KNOBS

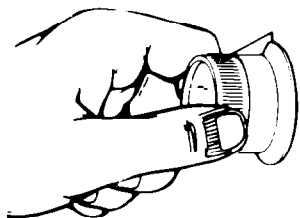

1. First make sure knobs are on OFF then pull knob straight off.



2. Use warm soapy water and a soft cloth to wipe the panel. Rinse and wipe dry.

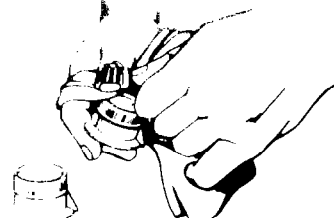

3. Wash knobs in warm soapy water. Rinse and dry.

4. Push knobs straight back on. Make sure they are on OFF.

CLEANING CHART

PART	WHAT TO USE	HOW TO CLEAN
Outside of oven	Soft cloth, warm soapy water Nylon or plastic scouring pad for stubborn spots	<ul style="list-style-type: none"> Wipe off regularly when oven is cool. Do not allow food containing acids (such as vinegar, tomato, lemon juice or milk) to remain on surface. Acids will remove the glossy finish. Do not use abrasive or harsh cleansers.
Control knobs	Warm, sudsy water and bristle brush	<ul style="list-style-type: none"> Wash, rinse and dry well. Do not soak
Porcelain-enamel broiler pan and grid	Warm, soapy water or soapy steel wool pads	<ul style="list-style-type: none"> Wash with other cooking utensils. Do not clean in self-cleaning cycle.
Control panel	Warm, soapy water Commercial glass cleaner	<ul style="list-style-type: none"> Wash, rinse and dry with soft cloth. Follow directions with cleaner.
Oven door glass	Warm, soapy water or plastic scrubbing pad Commercial glass cleaner	<ul style="list-style-type: none"> Make certain oven is cool. Wash, rinse and dry well with soft cloth. Follow directions provided with cleaner.
Continuous-cleaning lower oven	Warm, soapy water or soapy scrubbing pad	<ul style="list-style-type: none"> Clean stubborn spots or stains. Rinse well with clean water. Follow directions given on page 15. Do not use commercial oven cleaners. <p>Most fat spatters on the continuous-cleaning porcelain-enamel interior surface gradually reduce to a presentably clean condition during normal baking or roasting operations.</p>
Oven racks	Self-Cleaning Oven cycle Warm, soapy water or soapy steel wool pads	<ul style="list-style-type: none"> Leave in oven during Self-Cleaning cycle. Wash, rinse and dry. Use soapy steel wool pads for stubborn areas
Self-Cleaning Upper Oven	For areas outside Self-Cleaning area use warm, soapy water or soapy steel wool pads	<ul style="list-style-type: none"> Clean before using Self-Cleaning cycle to prevent burn-on of soil Follow directions given on page 11. Do not use commercial oven cleaners.

Do not use foil to line the bottom of your Self-Cleaning Oven.

THE OVEN DOOR

The upper oven door should not be removed.

REMOVING THE LOWER OVEN DOOR

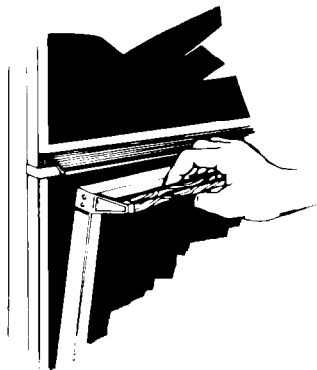

1. Open the door to the broil stop position.



WARNING: To avoid burns, be sure the oven is OFF and COOL.

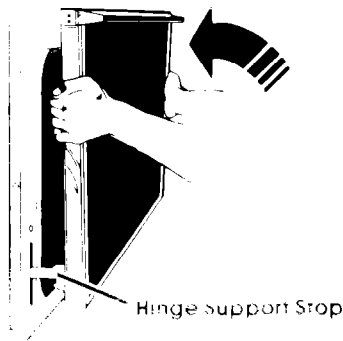

2. Hold the door on both sides and lift slightly to clear the stops in the hinge supports.



3. Pull the door, with the hinges, straight away from the oven.

REPLACING THE LOWER OVEN DOOR

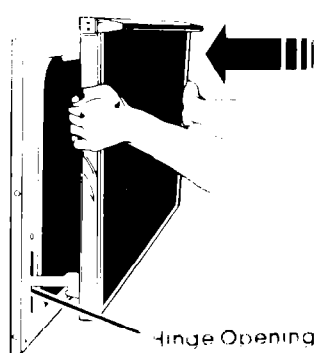

1. Fit the hinge supports into the openings at the bottom oven corners.



2. Lift slightly while sliding the hinge supports into the openings.

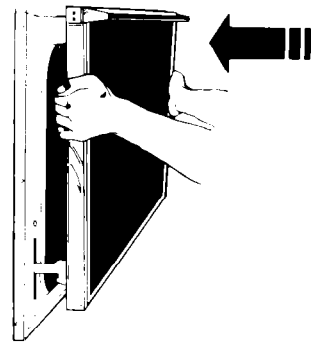

3. When the stops in the hinge supports slide into the oven openings, the door will snap into place and can be closed.

THE SELF-CLEANING UPPER OVEN CYCLE

The upper oven self-cleaning cycle uses **very high heat** to burn away soil. Before you start, make sure you understand exactly how to use the cycle safely.

BEFORE YOU START

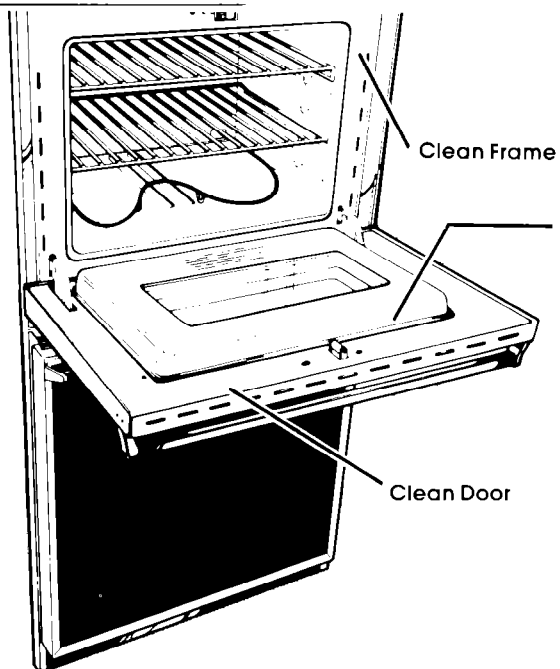

1. Clean areas that may not be cleaned during the cycle. Use hot water and detergent or a soapy steel-wool pad on...
 - the frame around the oven
 - the inside of the door, especially the part outside the oven seal.

DO NOT try to clean the fiberglass seal. **DO NOT** move it or bend it.

2. Remove any pots or pans you may have stored in the oven. They can't stand the high heat.
3. Wipe out any loose soil or grease. This will help reduce smoke during the cleaning cycle.

SPECIAL CAUTIONS

DO NOT block the vent during the cleaning cycle. Air must move freely for best results.

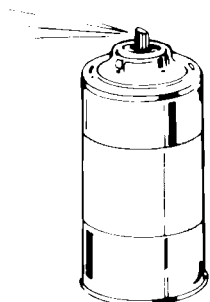

DO NOT use commercial oven cleaners in your oven. Damage to the porcelain finish may occur.

DO NOT touch the oven during the cleaning cycle...it can burn you.

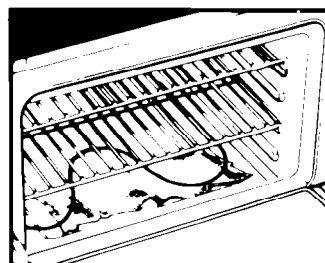

DO NOT use foil or other liners in the oven. During the cleaning cycle, they can burn or melt.

SETTING THE CONTROLS

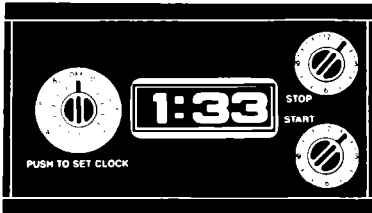

1. Make sure the clock and start and stop time dials all have the right time of day

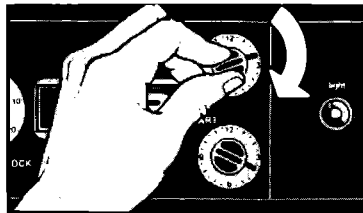

2. Push in the Stop Time Knob and turn the hand clockwise about two or three hours. (Two hours for light soil, three or more for heavier soil.)

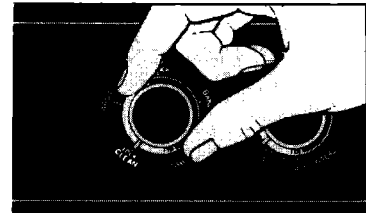

3. Set the Oven Selector to CLEAN. The Clean Light will come on and the door will lock automatically.

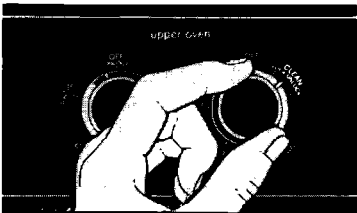

4. Set the Oven Temperature Control to CLEAN

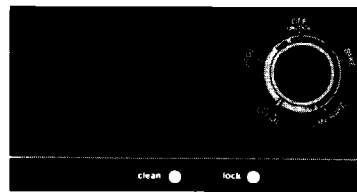

5. The Lock Light comes on when the oven gets above normal baking temperatures. The door can't be unlocked when the Lock Light is on.

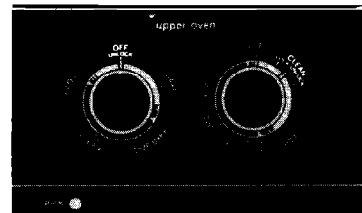

6. When the Lock Light goes off, turn the Oven Selector to OFF and leave the Oven Temperature Control at CLEAN. This unlocks the door.

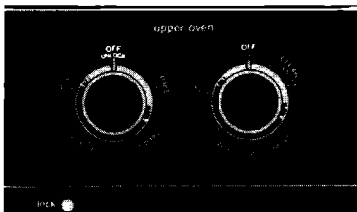

7. When the door is unlocked, turn the Oven Temperature Control to OFF.



8. After the oven is cool, wipe off any residue or ash with a damp cloth. If needed, touch up spots with cleanser or soapy steel wool pad.

DO NOT TOUCH THE OVEN DURING THE CLEANING CYCLE. IT CAN BURN YOU.

SPECIAL TIPS

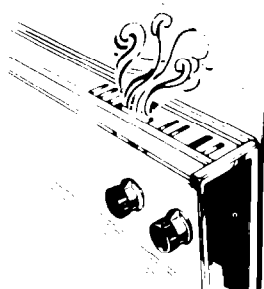

1. Keep the kitchen well ventilated during the cleaning cycle to help get rid of normal heat, odor, and smoke.

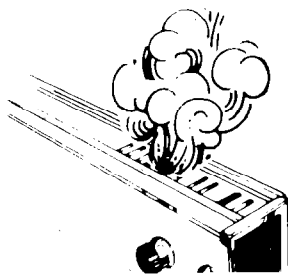

2. Clean the oven before it gets heavily soiled. Cleaning a very soiled oven takes longer and results in more smoke than usual.

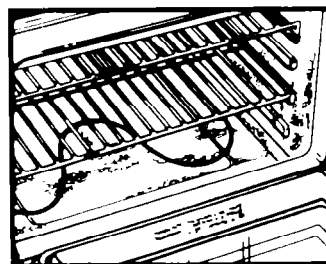

3. If the cleaning cycle doesn't get the oven as clean as you expected, the cycle may not have been set long enough. Set the cleaning time longer for heavier soil.

4. Oven racks lose their shine, discolor, and become harder to slide on their guides when they are left in the oven during the cleaning cycle. To make them slide easier, polish the edges of the racks, and rack guides with a scrubby steel wool pad, rinse well, and wipe on a thin coat of salad oil.

5. To stop the cleaning cycle after it has started:

- Turn the Stop Time Knob clockwise until the hand points to the right time of day.
- Turn the Oven Selector to OFF and leave the Oven Temperature Control at CLEAN.
- When the oven cools, you can open the door. Wait until the oven is cool.

HOW IT WORKS

During the self-cleaning cycle, the oven gets much hotter than it does for baking or broiling—approximately 875 F (468°C). This heat breaks up grease and soil and burns it off.

The graph shows approximate temperatures and times during a self-cleaning cycle for 3 hours.

SELF-CLEANING CYCLE -- THREE HOUR SETTING

(Approximate Temperatures and Times)

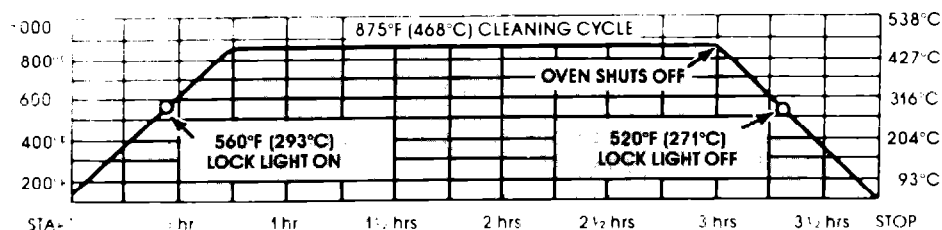

Notice that the heating stops when the 3-hour setting is up, but that it takes longer for the oven to cool down enough to unlock.

THE CONTINUOUS-CLEANING LOWER OVEN

Standard oven walls are coated with smooth porcelain-enamel. Your continuous-cleaning oven walls are coated with a special, rougher porcelain-enamel.

A fat spatter beads up on the smooth surface, but spreads out on the rougher surface. The bead of fat chars and turns black. The spread-out fat **gradually** burns away at **medium to high baking temperatures** (350–475 F, 176–231°C) so the oven can return to a presentably clean condition.

Fat Spatter
Beads Up
Turns Black

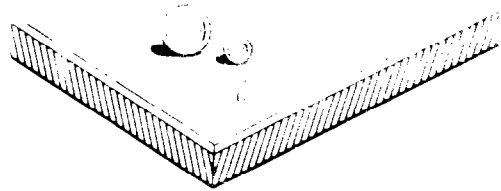

Standard porcelain-enamel

Fat Spatter
Spreads Out
Burns Away

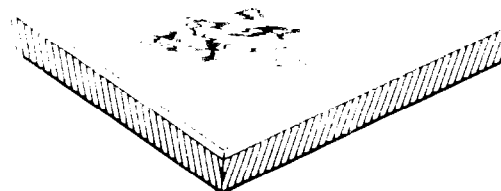

Continuous-cleaning porcelain-enamel

USING FOIL

Foil must be used on the lower oven bottom to catch spillovers. The foil must be used properly. Using foil in the self-cleaning upper oven is **not** recommended.

Cut foil from a roll of heavy-duty 18-inch (45 cm) aluminum foil, or buy a foil kit (part No. 241435) from your Whirlpool Appliance dealer.

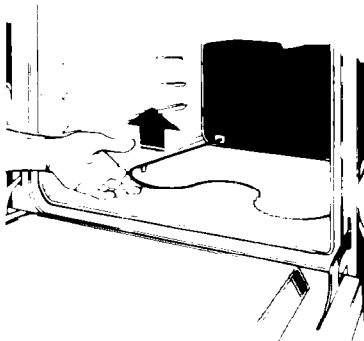

Lift the **cool bake element** slightly to lift the feet off the oven bottom.



Slide the foil under the bake element. Make sure foil is centered long enough to start up both sides, and lying flat without wrinkles.

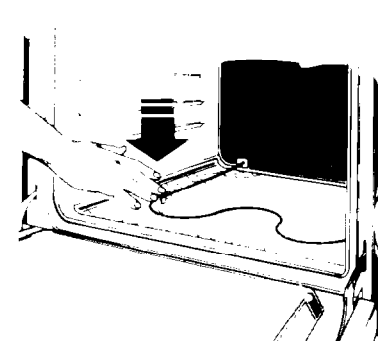

For proper baking, lower the bake element **so all feet rest solidly on the foil.**

TIPS

1. The oven window and racks are not coated. Clean them by hand.
2. The oven door does not get as hot as the walls. Some hand cleaning may be needed.
3. If you do more broiling than baking, hand cleaning may be needed.
4. Use aluminum foil on the oven bottom according to instructions. Spillovers do not burn away and may stain the bottom.

HAND CLEANING

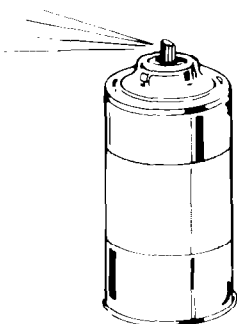

DO NOT USE OVEN CLEANING PRODUCTS. Some can be trapped in the porcelain-enamel surface and give off harmful fumes.

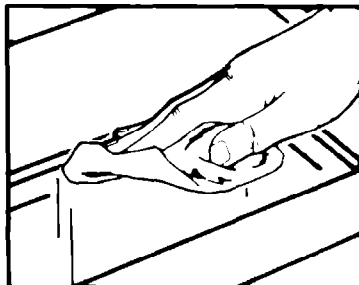

WINDOW – Keep clean with hot sudsy water. Do not use steel wool or abrasive cleansers. Use a plastic scouring pad for stubborn spots. Rinse well.

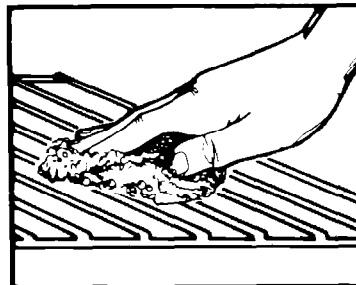

RACKS – Use a soapy steel-wool pad for best results. Rinse well.

WALLS AND DOOR – Wash with hot soapy water. Use a soapy steel-wool pad or plastic scouring pad for stubborn spots. Rinse well.

If you need service or assistance, we suggest you follow these four steps:

1. Before calling for assistance...

Performance problems often result from little things you can find and fix yourself without tools of any kind.

If nothing operates:

- Is the oven correctly wired to a live circuit with the proper voltage? (See **Installation Instructions**.)
- Have you checked your home's main fuses or circuit breaker box?

If the upper oven will not operate:

- Is the Upper Oven Selector turned to a setting (BAKE or BROIL, but not TIMED BAKE)?
- Is the Upper Oven Temperature Control turned to a temperature setting?

If the lower oven will not operate:

- Is the Lower Oven Selector turned to a setting (BAKE or BROIL)?
- Is the Lower Oven Temperature Control turned to a temperature setting?

If the self-cleaning cycle will not operate:

- Are the Upper Oven Selector and Upper Oven Temperature Controls set to "CLEAN"?
- Does the Start Time dial show the correct time of day?
- Is the Stop Time dial set ahead to the time you want the cleaning cycle to stop?

If soil is visible on continuous-cleaning oven finish:

- The special finish is designed to gradually reduce oven soil during normal baking or roasting. It is not designed to keep your oven spotless...only presentably clean.
- If you broil often, you may see oven soil.
- The door is cooler than oven walls. Soil will be more visible on the door than other areas in the oven. See page 15, "Hand Cleaning."

If cooking results aren't what you expect:

- Is the oven level?
- Are you using pans recommended in the **Cooking Guide**?
- If baking, have you allowed 1½ to 2 inches (4-5 cm) on all sides of the pans for air circulation?
- Does the oven temperature seem too low or too high? See page 4, "Resetting the oven temperature controls."
- Have you preheated the oven as the recipe calls for?
- Are the pans the size called for in the recipe?
- Are you following a tested recipe from a reliable source?
- Do the cooking utensils have smooth, flat bottoms?

See the **Cooking Guide** for more information on cooking problems and how to solve them.

2. If you need assistance* ...

Call the Whirlpool COOL-LINE® service assistance telephone number. Dial free from:

Continental U.S. (800) 253-1301
Michigan (800) 632-2243
Alaska & Hawaii (800) 253-1121

and talk with one of our trained Consultants. The Consultant can instruct you in how to obtain satisfactory operation from your appliance or, if service is necessary, recommend a qualified service company in your area.



FSP is a registered trademark of Whirlpool Corporation for quality parts. Look for this symbol of quality whenever you need a replacement part for your Whirlpool appliance.

FSP replacement parts will fit right and work right, because they are made to the same exacting specifications used to build every new Whirlpool appliance.



Benton Harbor, Michigan. Automatic Washers. Clothes Dryers. Freezers. Refrigerator-Freezers. Ice Makers. Dishwashers. Built-in Ovens and Surface Units. Ranges. Microwave Ovens. Compactors. Room Air Conditioners. Dehumidifiers. Central Heating and Air Conditioning Systems.

3. If you need service* ...



Whirlpool has a nationwide network of franchised TECH-CARE® Service Companies. TECH-CARE service technicians are trained to fulfill the product warranty and provide after-warranty service, anywhere in the United States. To locate TECH-CARE service in your area, call our COOL-LINE service assistance telephone number (see Step 2) or look in your telephone directory Yellow Pages under:

APPLIANCES—HOUSEHOLD—
MAJOR—SERVICE & REPAIR

WHIRLPOOL APPLIANCES
FRANCHISED TECH-CARE SERVICE

SERVICE COMPANIES
XYZ SERVICE CO.
123 Maple

ELECTRICAL APPLIANCES—
MAJOR—REPAIRING & PARTS

WHIRLPOOL APPLIANCES
FRANCHISED TECH-CARE SERVICE

SERVICE COMPANIES
XYZ SERVICE CO.
123 Maple

OR
WASHING MACHINES, DRYERS
& IRONERS—SERVICING

WHIRLPOOL APPLIANCES
FRANCHISED TECH-CARE SERVICE

SERVICE COMPANIES
XYZ SERVICE CO.
123 Maple

999-9999

4. If you have a problem* ...

Call our COOL-LINE service assistance telephone number (see Step 2) and talk with one of our Consultants, or if you prefer, write to:

Mr. Robert Stanley, Division Vice President
Whirlpool Corporation, 2000 US-33, North
Benton Harbor, MI 49022

*If you must call or write, please provide: model number, serial number, date of purchase, and a complete description of the problem. This information is needed in order to better respond to your request for assistance.