



ELECTRIC AND GAS DRYERS

Use & Care Guide

Table of Contents.....	2
------------------------	---

Models
3RLER5437, 3RLGR5437,
3RLEC8646, 3RLEQ8000

TABLE OF CONTENTS

DRYER SAFETY	3
PARTS AND FEATURES	5
CHECKING YOUR VENT	6
DRYER USE	7
Starting Your Dryer.....	7
Stopping and Restarting	7
Loading Clothes	8
Drying, Cycle, and Temperature Tips	8
Cycle Descriptions	8
Additional Features	9
Drying Rack.....	9
DRYER CARE	10
Cleaning the Lint Screen.....	10
Cleaning the Dryer Interior	10
Removing Accumulated Lint from Inside the Dryer Cabinet	10
Regular Servicing	10
TROUBLESHOOTING	11
ASSISTANCE OR SERVICE	12

DRYER SAFETY

Your safety and the safety of others are very important.

We have provided many important safety messages in this manual and on your appliance. Always read and obey all safety messages.



This is the safety alert symbol.

This symbol alerts you to potential hazards that can kill or hurt you and others.

All safety messages will follow the safety alert symbol and either the word "DANGER" or "WARNING." These words mean:

! DANGER

You can be killed or seriously injured if you don't immediately follow instructions.

! WARNING

You can be killed or seriously injured if you don't follow instructions.

All safety messages will tell you what the potential hazard is, tell you how to reduce the chance of injury, and tell you what can happen if the instructions are not followed.

WARNING: For your safety, the information in this manual must be followed to minimize the risk of fire or explosion, or to prevent property damage, personal injury, or death.

- Do not store or use gasoline or other flammable vapors and liquids in the vicinity of this or any other appliance.
- **WHAT TO DO IF YOU SMELL GAS:**
 - Do not try to light any appliance.
 - Do not touch any electrical switch; do not use any phone in your building.
 - Clear the room, building, or area of all occupants.
 - Immediately call your gas supplier from a neighbor's phone. Follow the gas supplier's instructions.
 - If you cannot reach your gas supplier, call the fire department.
- Installation, service, or conversions for use on other gas supplies must be performed by a qualified installer, service agency, or the gas supplier.

IMPORTANT SAFETY INSTRUCTIONS

WARNING: To reduce the risk of fire, electric shock, or injury to persons when using the dryer, follow basic precautions, including the following:

- Read all instructions before using the dryer.
- Make sure the room containing the dryer has an adequate air supply for gas combustion and/or drying operation. A window or equivalent means of ventilation must be opened in the room when the dryer is in use (an equivalent form of opening includes an adjustable louvre, hinged panel, or other means of ventilation that opens directly to outside air).
- Keep a minimum clearance of 10 cm (4 in.) between the rear of the dryer and any wall.
- The operation of this appliance may affect the operation of other types of gas appliances which take their air supply for safe combustion from the same room. If in doubt, consult the appliance manufacturers.
- Do not obstruct the air supply to the dryer (see Installation Instructions for minimum clearances).
- Do not place items exposed to cooking oils in your dryer. Items contaminated with cooking oils may contribute to a chemical reaction that could cause a load to catch fire.
- Do not dry articles that have been previously cleaned in, washed in, soaked in, or spotted with gasoline, dry-cleaning solvents, cooking oils, or other flammable, or explosive substances as they give off vapours that could ignite or explode.
- Do not allow children to play on or in the dryer. Close supervision of children is necessary when the dryer is used near children.
- Before the dryer is removed from service or discarded, remove the door to the drying compartment.
- Do not reach into the dryer if the drum is moving. A door switch is fitted for your safety.
- Do not install or store the dryer where it will be exposed to the weather.
- Do not tamper with controls.
- Do not continue to use this appliance if it appears to be faulty.
- Do not repair or replace any part of the dryer or attempt any maintenance unless specifically recommended in this Use and Care Guide. Repairs and servicing should only be carried out by competent service personnel.
- Do not use fabric softeners or products to eliminate static unless recommended by the manufacturer of the fabric softener or product.
- Do not use heat to dry articles containing foam rubber or similarly textured rubber-like materials.
- Always use the cool-down period at end of drying cycle to avoid a heat build-up in stored clothes.
- Clean lint screen before or after each load. Do not operate dryer without lint screen in place.
- Keep area around the exhaust and inlet openings and adjacent surrounding areas free from the accumulation of lint, dust, and dirt.
- The interior of the dryer and exhaust vent should be cleaned periodically by qualified service personnel.
- See Installation Instructions for earthing requirements.

SAVE THESE INSTRUCTIONS

PARTS AND FEATURES

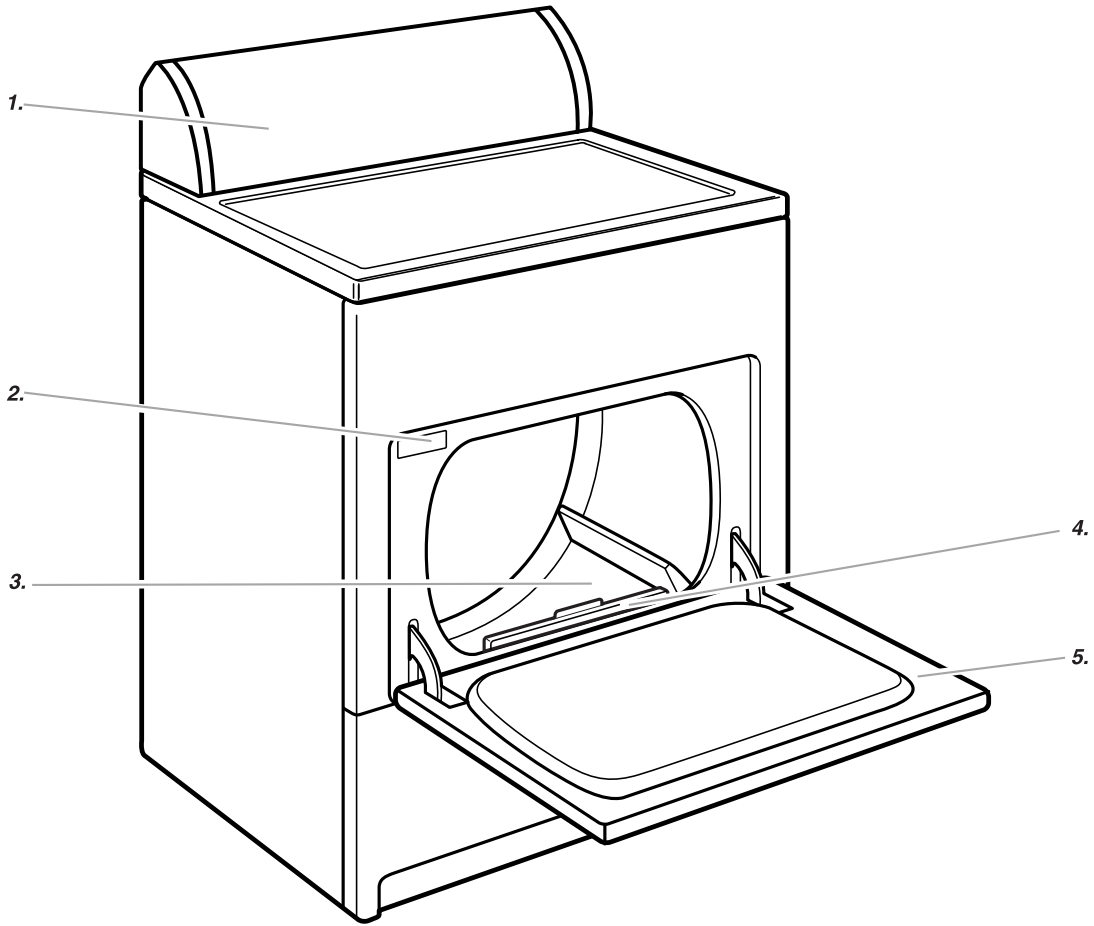

1. Control panel
2. Model and serial number label
3. Dryer drum
4. Lint screen
5. Wide-opening door

Additional features your dryer may have

Super wide-swing door

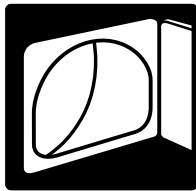

End of Cycle Signal selector

Wrinkle Guard selector

Automatic Dry sensor

Optional purchase

Drying rack

Control Panel

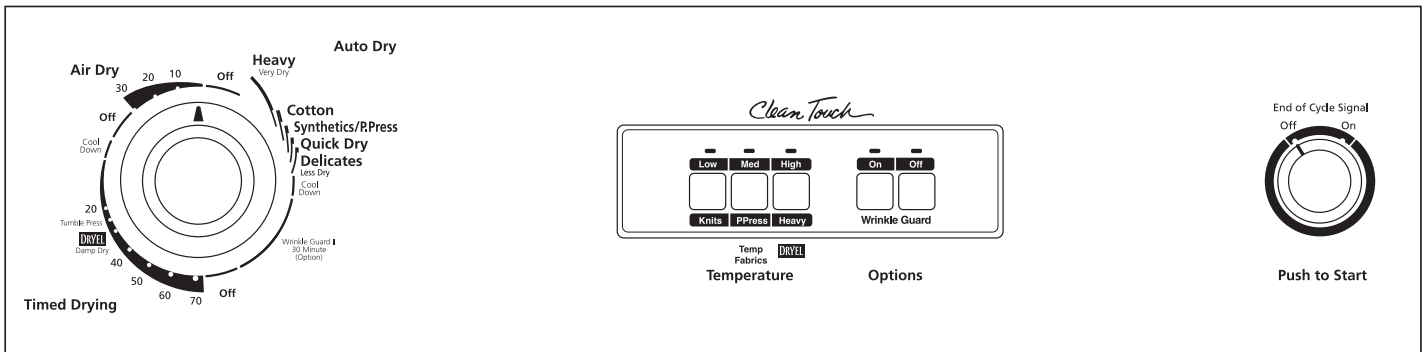

CHECKING YOUR VENT

Your dryer must be properly installed and vented to achieve maximum drying efficiency and shorten drying times. Use the minimum recommended installation clearances (found in your Installation Instructions) to avoid blocking the flow of combustion and ventilation air. Refer to your Installation Instructions for more information.

! WARNING



Fire Hazard

Use a heavy metal vent.

Do not use a plastic vent.

Do not use a metal foil vent.

Failure to follow these instructions can result in death or fire.

If the dryer is not properly installed and vented, it will not be covered under the warranty.

NOTE: Service calls caused by improper venting will be paid for by the customer, whether it was a paid installation or self-installed.

- Do not** use plastic vent or metal foil vent. Use a 10.2 cm (4 in.) metal or flexible metal vent. Do not kink or crush flexible metal vent. It must be completely extended to allow adequate exhaust air to flow. Check vent after installation. Refer to your Installation Instructions for proper length requirements of vent.

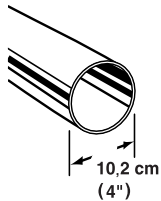

- Use a 10.2 cm (4 in.) exhaust hood. Smaller hoods increase drying times.

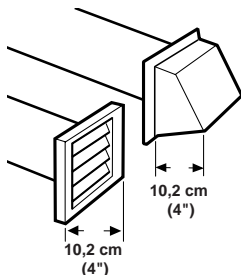

- The exhaust vent can be routed up, down, left, right, or straight out the back of the dryer. Space requirements are listed in your Installation Instructions.

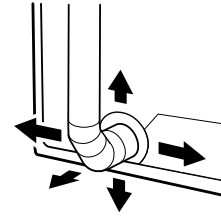

- Use the straightest path possible when routing the exhaust vent. Use the fewest number of elbows and turns. Allow room when using elbows or making turns. Bend vent gradually to avoid kinking.

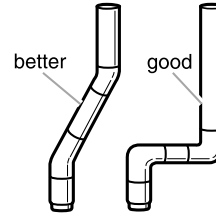

- Use duct tape to seal all joints. **Do not** use screws to secure vent. Lint may catch on screws.

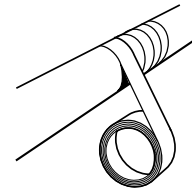

- Clean exhaust vent periodically, depending on use, but at least every 2 years, or when installing your dryer in a new location.

- Disconnect vent from the dryer and clean one section at a time until you reach the exhaust hood.

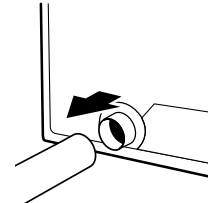

- To clean out lint, use the hose attachment on your vacuum, or a pole or wire with a feather duster or rag attached.
- Be sure the flapper on the outside end of vent moves freely.
- When cleaning is complete, be sure to follow the Installation Instructions supplied with your dryer for final product check.

DRYER USE

Starting Your Dryer

! WARNING



Explosion Hazard

Keep flammable materials and vapors, such as gasoline, away from dryer.

Do not dry anything that has ever had anything flammable on it (even after washing).

Failure to follow these instructions can result in death, explosion, or fire.

! WARNING



Fire Hazard

No washer can completely remove oil.

Do not dry anything that has ever had any type of oil on it (including cooking oils).

Items containing foam, rubber, or plastic must be dried on a clothesline or by using an Air Cycle.

Failure to follow these instructions can result in death or fire.

Before using your dryer, wipe the dryer drum with a damp cloth to remove dust from storing and shipping.

1. Load clothes loosely into the dryer and close the door. Do not pack the dryer. Allow space for clothes to tumble freely. Maximum clothing load (cotton fabrics) is 9.1 kg (20 lb).



2. Turn the Cycle Control knob to the recommended cycle for the type of load being dried. Use the Energy Preferred Automatic Setting (*) to dry most heavyweight and medium weight loads. See "Drying, Cycle, and Temperature Tips."

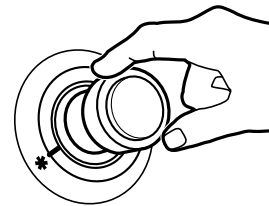

3. Select a temperature setting on models with a Temp/Fabric selector. The cycle descriptions include temperature setting suggestions.
NOTE: The temperature selector is part of the Cycle Control knob on some models.
4. Select the End of Cycle Signal, if available. The signal is helpful when drying permanent press or synthetics. Promptly remove these items from the dryer at the end of the cycle to prevent wrinkles.
5. Select the desired option. See "Additional Features."
6. Push the START button. Your gas dryer has an electronic ignition system for the burner which is fully automatic; no action is needed by the user (there is no pilot light).

NOTE: Your dryer stops automatically when a cycle ends.

Stopping and Restarting

You can stop your dryer any time during a cycle.

To stop your dryer

Open the dryer door or turn the Cycle Control knob to OFF.

NOTE: The Cycle Control knob should point to an Off area when the dryer is not in use.

To restart your dryer

1. Close the door.
2. Select a new cycle and temperature (if desired).
3. Push START.

Loading Clothes

Load clothes loosely into the dryer. Do not pack the dryer. Allow space for clothes to tumble freely. The following chart shows examples of balanced loads that would allow for proper tumbling.

Heavy work clothes	3 pair of pants, 4 pair of jeans, 2 pair of overalls, 3 shirts
Delicates	3 camisoles, 1 robe, 4 slips, 6 undergarments, 2 sets of sleepwear, 1 child's outfit
Towels	10 bath towels, 10 hand towels, 14 wash cloths, 1 bath mat
Mixed Load	3 double sheets, 4 pillowcases, 8 T-shirts, 6 pair of shorts, 2 blouses, 8 handkerchiefs

Drying, Cycle, and Temperature Tips

Select the correct cycle and temperature for your load.

Cool Down tumbles the load without heat during the last few minutes of all cycles to make the load easier to handle.

Drying tips

- Follow care label directions when they are available.
- If you use fabric softener sheets, use only those labeled "dryer safe." Follow package instructions.
- Remove the load from the dryer as soon as tumbling stops to reduce wrinkling. This is especially important for permanent press, knits, and synthetic fabrics.

Cycle and temperature tips

- Dry most loads using the Energy Preferred Automatic Setting (*).
- Use a High Heat setting for drying heavyweight items such as towels and work clothes.
- Use a Medium Heat setting for drying medium weight items, such as sheets, underwear, permanent press fabrics, and some knits.
- Use a Low Heat setting for drying lightweight items such as lingerie, blouses, dresses, and some knits.
- Use a no-heat (air) setting for rubber, plastic, or heat-sensitive fabrics.
- Line dry bonded or laminated fabrics.

If you are unsure of the temperature to select for a load, select a lower setting rather than a higher setting.

NOTE: If you have questions about drying temperatures for various loads, refer to the care label directions.

Cycle Descriptions

This manual covers several different models. Your dryer may vary from the model shown, and may not have all of the cycles and features described.

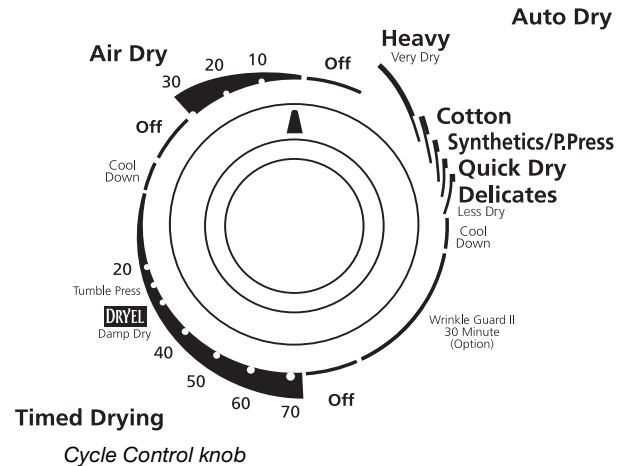

Auto Dry cycle

Use your Automatic cycle to dry most loads. Your dryer has a control that senses the moisture level in the load and shuts off when the load reaches the selected dryness.

- Select the temperature from the temperature selector based on the fabrics in your load.
- After drying a load, check the dryness.
- If the load is drier than you like, select a setting closer to Less Dry the next time you dry a similar load.
 - If a load is not as dry as you like, complete drying using a Timed cycle. Select a setting closer to Very Dry the next time you dry a similar load.

NOTE: Drying time varies with an Automatic cycle. The type of fabric, the size of the load, and the dryness selected affect drying time. See "Drying, Cycle, and Temperature Tips."

Timed Drying cycle(s)

Use your Timed drying cycle to complete drying if items are still damp after the Automatic cycle. Also use Timed Drying for heavyweight and bulky items, such as bedspreads and work clothes or large loads that require a long drying time. Set the temperature selector, if available, to High Heat.

On some models, you may use the Timed Drying cycle for lightweight items such as lingerie or knits. Set the temperature selector, if available, based on the fabrics in your load.

Air Fluff or Air Dry cycles

Use the Air Fluff or Air Dry cycle for items that require drying without heat such as rubber, plastic, and heat-sensitive fabrics. Set the Cycle Control knob to Air Fluff or Air Dry. This chart shows examples of items that can be dried using the Air Fluff or Air Dry cycle.

Type of Load	Air Fluff or Air Dry cycle*
Foam rubber—pillows, padded bras, stuffed toys	20 - 30
Plastic—Shower curtains, tablecloths	20 - 30
Rubber-backed rugs	40 - 50
Olefin, polypropylene, sheer nylon	10 - 20

*(Minutes). Reset cycle to complete drying if needed.

When using Air Fluff or Air Dry

- Check to see that coverings are securely stitched.
- Shake and fluff pillows by hand periodically during cycle.
- Dry item completely. Foam rubber pillows are slow to dry.

Additional Features

This manual covers several different models. Your dryer may not have all of the features described.

Heavy/Heavy Dry

Select this setting to evenly dry large or heavy items such as thick cotton bath towels or robes. Set the Temperature selector, if available, to High Heat.

Cotton

Select this setting to thoroughly dry heavy items such as sheets, mattress pads and quilts, or a load of towels. Set the temperature selector, if available, to High Heat.

Synthetics/Permanent Press

Select this cycle to dry medium to lightweight synthetic or no-iron items such as shirts, blouses, or dresses. Choose a Medium Heat setting if available.

Quick Dry

Use this cycle for drying small loads or loads that need a short drying time. Choose a High or Medium Heat setting depending on the type of fabrics being dried.

Delicates

Select this option to dry small loads or lightweight items. Set the temperature selector, if available, to Low or Extra Low Heat.

TUMBLE PRESS® setting

Select this setting to remove wrinkles from items such as clothing packed in a suitcase or items wrinkled from being left in the dryer too long. Set the temperature selector, if available, to Medium or Low Heat depending on the fabrics in your load.

Damp Dry

Select this setting to dry items to a damp level, or to dry items that do not require an entire drying cycle. Damp dry items such as jeans (to prevent stiffness) or cotton clothing (to make pressing easier). Set the temperature selector, if available, to High Heat.

Wrinkle Guard II

When you are unable to remove a load from the dryer as soon as it stops, wrinkles can form. The Wrinkle Guard II feature periodically tumbles, rearranges, and fluffs the load for up to 30 minutes without heat to avoid wrinkles. Press the Wrinkle Guard ON button to enable the Wrinkle Guard II feature. A signal will sound periodically when the Wrinkle Guard II feature is on if the End of Cycle Signal is selected. The signal and the tumbling will end when you open the dryer door, or when you turn the Cycle Control knob to Off.

DRYEL® fabric care system

When using DRYEL fabric care, select the DRYEL cycle setting and the DRYEL temperature setting. DRYEL fabric care, when used in accordance with the manufacturer's directions, has been tested and approved for use in full-size dryers built by Whirlpool Corporation.

End of Cycle Signal

- The End of Cycle signal sounds when a cycle is complete. If your End of Cycle signal is selectable, the signal will sound only if set to On.
- If the Wrinkle Guard feature is on, the signal sounds every few minutes. The signal stops when you open the door or turn the Cycle Control knob to Off.

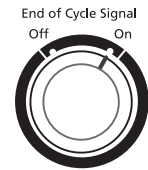

Drying Rack (optional)

The drying rack is useful for machine drying items you would not necessarily want to tumble dry or that you would normally line dry (for example, tennis shoes, pillows, stuffed toys).

If your model does not have a drying rack, you can order one by contacting the dealer from whom you purchased your dryer.

To use the drying rack

1. Slide rear pegs into the dimples on the back wall of the dryer. Lower the front legs to rest on the dryer opening.

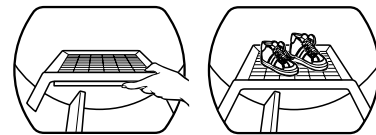

2. Put the wet items on top of the rack. Leave space between the items so air can reach all the surfaces. Close the door.
NOTE: Do not allow items to hang over the edge of the rack.
3. Select a timed drying cycle and temperature, or select an air cycle. Items containing foam, rubber, or plastic must be dried on a clothesline or by using an air cycle.
4. Push the START button.

NOTE: The rack must be removed for normal tumbling. Do not use the automatic cycle with the drying rack.

This chart shows examples of items that can be rack-dried and the suggested cycle, temperature setting, and drying time. Actual drying time will depend on the amount of moisture items hold.

Rack Dry	Cycle	Temp	Time*
Wool Sweaters Block to shape and lay flat on the rack	Timed	Low	60
Stuffed toys or pillows Cotton or polyester fiber filled	Timed	Low	60
Stuffed toys or pillows Foam rubber filled	Air (no heat)	None	90
Sneakers or canvas shoes	Air (no heat)	None	90

*(Minutes). Reset cycle to complete drying if needed.

DRYER CARE

Cleaning the Lint Screen

Every load cleaning

The lint screen is located in the door of the dryer. Clean it before each load. A screen blocked by lint can increase drying time.

To clean

1. Pull the lint screen toward you. Roll lint off the screen with your fingers. Do not rinse or wash screen to remove lint. Wet lint is hard to remove.

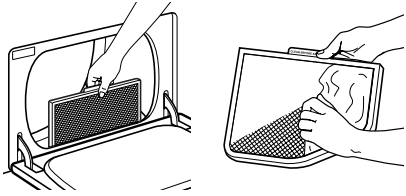

2. Push the lint screen firmly back into place.

IMPORTANT:

- Do not run the dryer with the lint screen loose, damaged, blocked, or missing. Doing so can cause overheating and damage to both the dryer and fabrics.
- Some towels made of synthetic fibers and natural fibers (polyester and cotton blends) may shed more lint than other towels, causing your dryer's lint screen to fill up faster. Be sure to remove lint from the lint screen before and after drying new towels.
- If lint falls off the screen into the dryer during removal, check the exhaust hood and remove the lint. See "Checking Your Vent."

As-needed cleaning

Laundry detergent and fabric softener residue can build up on the lint screen. This buildup can cause longer drying times for your clothes, or cause the dryer to stop before your load is completely dry. The screen is probably clogged if lint falls off the screen.

Clean the lint screen with a nylon brush every six months, or more frequently if it becomes clogged due to a residue buildup.

To wash

1. Wet both sides of lint screen with hot water.
2. Wet a nylon brush with hot water and liquid detergent. Scrub lint screen with the brush to remove residue buildup.

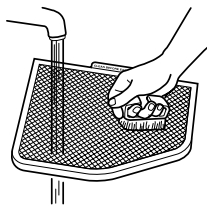

3. Rinse screen with hot water.
4. **Thoroughly** dry lint screen with a clean towel. Insert lint screen back into dryer.

Cleaning the Dryer Interior

! WARNING



Explosion Hazard

Use nonflammable cleaner.

Failure to do so can result in death, explosion, or fire.

To clean dryer drum

1. Make a paste with powdered laundry detergent and very warm water.
2. Apply paste to a soft cloth.

OR

Apply a liquid, non-flammable household cleaner to the stained area and rub with a soft cloth until all excess dye is removed.

3. Wipe drum thoroughly with a damp cloth.
4. Tumble a load of clean cloths or towels to dry drum.

NOTE: Garments which contain unstable dyes, such as denim blue jeans or brightly colored cotton items, may discolor the dryer interior. These stains are not harmful to your dryer and will not stain future loads of clothes. Dry unstable dye items inside-out to prevent dye transfer.

Removing Accumulated Lint from Inside the Dryer Cabinet

Lint can gather inside the dryer and be a fuel for fire. Lint should be removed every two to three years, or more often, depending on dryer usage. Cleaning should be done by a competent service person. If you have any questions or comments, please call a designated Whirlpool® service company.

Regular Servicing

To keep your dryer operating safely at best efficiency, regular servicing by a designated Whirlpool service technician is recommended. For normal use, this should be at 12 monthly intervals. For heavy-duty usage, this interval should be reduced accordingly.

TROUBLESHOOTING

First try the solutions suggested here and possibly avoid the cost of a service call...

Clothes are not drying satisfactorily

- **Check the following:**
 - Is the lint screen clogged with lint?

Is the exhaust vent or outside exhaust hood clogged with lint, restricting air movement? Run the dryer for 5-10 minutes. Hold your hand under the outside exhaust hood to check air movement. If you do not feel air movement, clean exhaust system of lint or replace exhaust vent with heavy metal or a flexible metal vent. See “Installation Instructions.”

Is the exhaust vent crushed or kinked? Replace with a heavy metal or a flexible metal vent. See “Installation Instructions.”

Has the electricity supply fuse blown, or has a circuit breaker tripped?

Has an air dry cycle been selected? Select the right cycle for the types of garments being dried. See “Drying, Cycle, and Temperature Tips.”

For gas dryers, is the valve open on the supply line?

Are fabric softener sheets blocking the grill? Use only one fabric softener sheet and use it only once.
 - **Is the dryer located in a room with temperature below 45°F (7°C)?**

Proper operation of dryer cycles requires temperatures above 45°F (7°C).
 - **Was a cold rinse water used? Was the load very wet?**

Expect longer drying times with items rinsed in cold water and with items that hold moisture (cottons).
 - **Is the load too large and heavy to dry quickly?**

Separate the load to tumble freely.
-

Dryer will not run

- **Check the following:**
 - Is the electricity supply connected?

Has the electricity supply fuse blown, or has a circuit breaker tripped?

Was a regular fuse used? Use a time-delay fuse.

Is the dryer door firmly closed?

Was the START button firmly pressed?

Is a cycle selected?
-

Unusual sounds

- **Has the dryer had a period of non-use?**

If the dryer hasn't been used for a while, there may be a thumping sound during the first few minutes of operation.
 - **Is it a gas dryer?**

The gas valve clicking is a normal operating sound.
-

Lint on load

- **Is the lint screen clogged?**

Clean lint screen. Check for air movement.
 - **Is the load properly sorted?**

Sort lint givers (towels, chenille) from lint takers (corduroy, synthetics). Also sort by color.
 - **Is the load too big or too heavy?**

Dry smaller loads so lint can be carried to the lint screen.
 - **Was the load overdried?**

Use correct dryer settings for load type. Overdrying can cause lint-attracting static electricity. See “Drying, Cycle, and Temperature Tips.”
 - **Was paper or tissue left in pockets?**
 - **Is pilling being mistaken for lint?**

Pilling (surface fuzz) is caused by normal wear and laundering.
-

Stains on load or color change

- **Was dryer fabric softener properly used?**

Add dryer fabric softener sheets at the beginning of the cycle. Fabric softener sheets added to a partially-dried load can stain your garments.
 - **Were items soiled when placed in the dryer?**

Items should be clean before being dried.
 - **Were items properly sorted?**

Sort light colors from dark colors. Sort colorfast items from noncolorfast items.
-

Items shrinking

- **Was the dryer overloaded?**

Dry smaller loads that can tumble freely.
 - **Did the load overdry?**

Check the manufacturer's care label. Match dryer setting to load type. See “Drying, Cycle, and Temperature Tips.”
-

Loads are wrinkled

- **Was the load removed from the dryer at end of the cycle?**

Remove load as soon as tumbling stops.
 - **Was the dryer overloaded?**

Dry smaller loads that can tumble freely.
 - **Did the load overdry?**

Check the manufacturer's care label. Match dryer setting to load type. See “Drying, Cycle, and Temperature Tips.”
-

Odors

- **Have you recently been painting, staining or varnishing in the area where your dryer is located?**

If so, ventilate the area. When the odors or fumes are gone from the area, re-wash and dry the clothing.
 - **If the dryer is electric, is it being used for the first time?**

The new electric heating element may have an odor. The odor will be gone after the first cycle.
 - **If the dryer is gas, there may be a gas leak.**

Turn off the gas supply line, leave your house, and then call your local gas company.
-

Garment damage

■ **Check the following:**

- Were zippers, snaps, and hooks left open?
- Were strings and sashes tied to prevent tangling?
- Were care label instructions followed?
- Were items damaged before drying?

If you still have problems, see the Assistance or Service section.

ASSISTANCE OR SERVICE

Before calling for assistance or service, please check the Troubleshooting section. It may save you the cost of a service call. If you still need help, follow these instructions.

If you need assistance or service

If your problem is not due to any of the items listed in the Troubleshooting section, contact the dealer from whom you purchased the dryer, or a designated Whirlpool service company.

When calling, please know the purchase date, and the complete model and serial number of your appliance. This information will help us better respond to your request.

If you need replacement parts

FSP® is a protected trademark of Whirlpool Corporation for quality parts. Look for this symbol of quality whenever you need a replacement part. FSP replacement parts will fit right and work right because they are made to the same exacting specifications used to build every new WHIRLPOOL® appliance.

To locate FSP replacement parts in your area, contact the dealer from whom you purchased the dryer, or a designated Whirlpool service company.

For further assistance

If you need further assistance, you can write or call with any questions or concerns at:

Whirlpool UK Ltd.
209 Purley Way
Croydon
CR9 4RY
U.K.
Telephone: 181 649 5000