



JENN-AIR

garbage disposer

INSTALLATION, USE AND CARE MANUAL

HOW THIS GUIDE WILL HELP YOU

This brochure describes everything you need to know to install your new garbage disposer. If you take your time, follow the clear descriptions and drawings, you should have no trouble making a first-rate installation. Note: Read through the entire manual before you start installation so you can get all the tools and materials you will need with one trip to the store.

These are the tools and materials you will need.

SCREWDRIVER

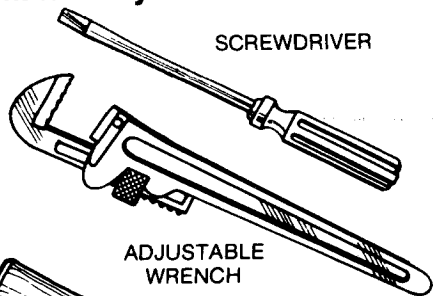

ADJUSTABLE
WRENCH

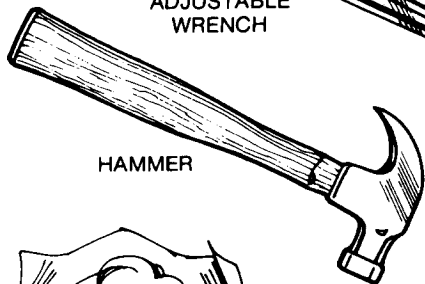

HAMMER

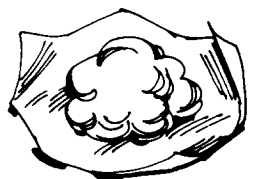

PLUMBER'S PUTTY (1/4 lb.)



WIRE NUTS
(2 - Size 54)

These are the tools and materials you may need.

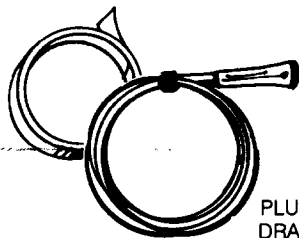

PLUMBER'S
DRAIN, ROD
OR AUGER



ON-OFF
ELECTRICAL
SWITCH
(1/2 H.P., 15-20 AMP.)



PIPE WRENCH

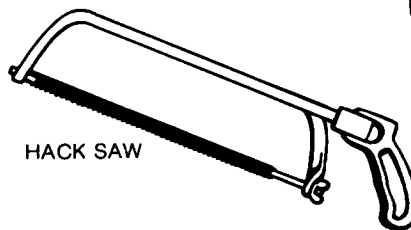

HACK SAW

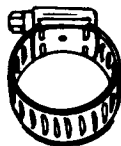

WORM
GEAR CLAMP



COPPER WIRE



DISHWASHER DRAIN
CONNECTING KIT

INSTALLATION DIMENSIONS

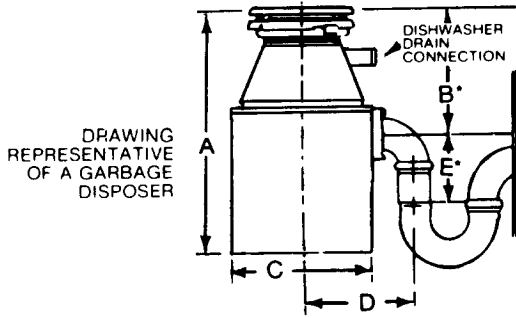

Model No.	A	B*	C	D	E*
GC430	12 ³ / ₄ "	6 ¹¹ / ₁₆ "	4"	7"	5 ³ / ₄ "
GC410	12 ⁵ / ₈ "	5 ¹⁵ / ₁₆ "	4"	6 ⁵ / ₁₆ "	5"

B* — Distance from bottom of sink to center line of disposer outlet. Add 1/2" when stainless steel sinks are used.

E* — Length of discharge tube from center line of disposer outlet to end of discharge tube.

IMPORTANT: Plumb waste line to prevent standing water in disposer motor housing

1 START BY CLEANING YOUR SINK'S DRAIN LINE. (If you have a brand new home, you can skip this step.)

The cutting elements on your old disposer were probably worn and not grinding the waste completely. Your drain line may be partially blocked. We recommend cleaning the line before connecting your new disposer. You can do the job yourself with a drain auger. Remove the drain trap and, using the auger, clean out the horizontal drain pipe that runs from the trap to the main waste pipe.

2 ELECTRICAL SUPPLY

Your disposer may be wired either directly to a wall switch or a switch controlled grounded double wall receptacle. During installation, of a double wall receptacle, one receptacle should be installed with a wall switch in the circuit, the other should be wired direct like a standard wall outlet.

Before you attack this job, you should be thoroughly familiar with electrical power and proper procedures. If you aren't, call in a professional who is knowledgeable.

This appliance is equipped with copper wires. Use 3 conductor copper cable in accordance with your local code to make your connections to the unit.

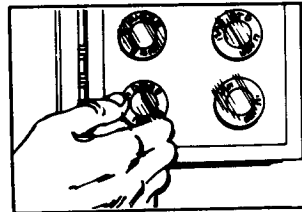

First, remove the fuse or open the circuit breaker on the circuit you plan to use for your disposer. Use a separate 15 amp, 115 volt circuit just for the disposer. If you are replacing a unit, skip to step 3. Next, use 15-20 amp, 115 volt cable to make a connection from the junction box to the on-off switch.

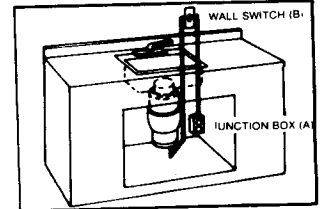

Install a junction box and switch. (Obtain 1/2 H.P., 15-20 amp rated on-off switch and electrical wiring locally.) Position the switch in any convenient location, and connect to junction box. All wiring must comply with local electrical codes. 14 gauge size wire is the smallest permissible for use with a 15 amp circuit, and 12 gauge size wire is the smallest permissible for use with a 20 amp circuit.

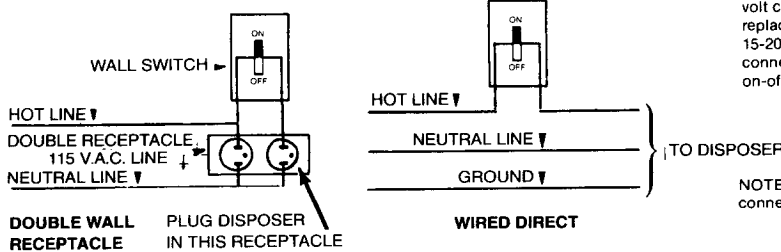

NOTE: See 10 & 11 for final electrical connections.

All wiring must comply with local electrical codes.

3 CHECK THE PARTS AGAINST THE DRAWINGS BELOW AND MAKE SURE EVERYTHING IS THERE. (Your new disposer may not look like the one pictured.)

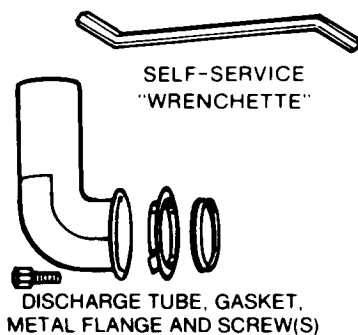

THE MOUNTING ASSEMBLY CONSISTING OF:

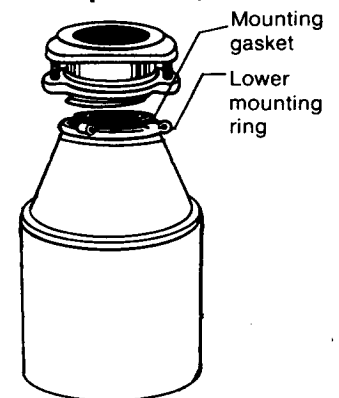
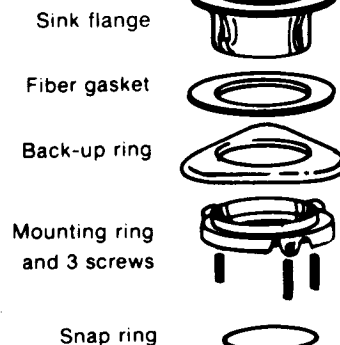

THE UNIT ITSELF

4 HERE IS WHAT YOU DO IF YOU ARE REPLACING AN OLD DISPOSER.

FIRST, TURN OFF ELECTRICAL POWER at the service panel (fuse box or circuit breaker box). If the mounting is the same as your new disposer's mounting, you can use the existing mounting. Follow instructions A through E, Step 4, then go on to Step 10.

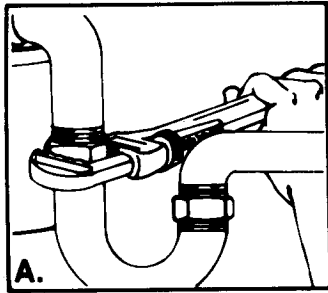

Use a pipe wrench to disconnect the drain line where it attaches to the disposer discharge tube.

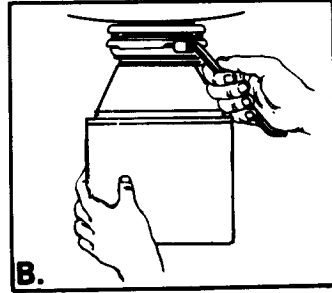

IF YOUR OLD DISPOSER HAS A DIFFERENT MOUNTING THAN YOUR NEW ONE, GO ON TO INSTRUCTION C.

If your old disposer has the same mounting as your new one, insert the end of your "wrenchette" or screwdriver into the right side of one of the disposer mounting ring lugs at the top of the disposer. Then, turn the "wrenchette" or screwdriver to the left (counterclockwise) until the lug lines up with one of the sink mounting assembly screws.

CAUTION: Be sure to hold the disposer with one hand while performing this step or it may fall when the mounting ring is disconnected from the sink mounting assembly. GO TO INSTRUCTION D.

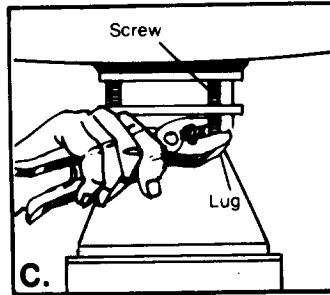

If your old disposer has a different mounting than your new one, use a pliers or adjustable wrench to remove the nuts on the mounting ring. Then remove old disposer. (Some disposers have to be removed by taking off a clamp or by twisting the disposer to remove it from its mounting. Easy to figure out.)

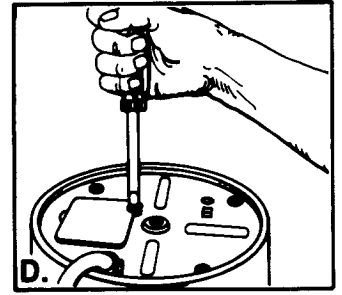

Once the disposer is off, turn it upside down and remove the electrical plate.

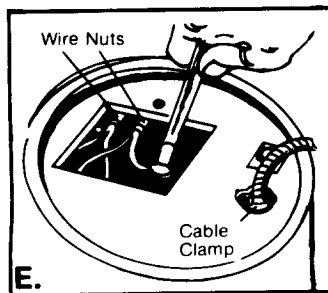

Now, use a screwdriver to remove ground wire. Remove the wire nuts from the power wires. Separate the disposer power wires from the cable wires. Loosen the screw(s) on the cable clamp and remove the cable from the disposer.

If your old disposer has a different mounting than your new one, follow steps F and G. Otherwise go on to Step 3.

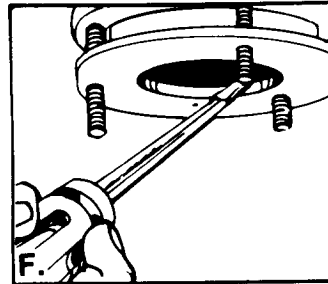

Loosen screws and remove old mounting ring and back-up ring. You may need a hammer to loosen assembly parts.

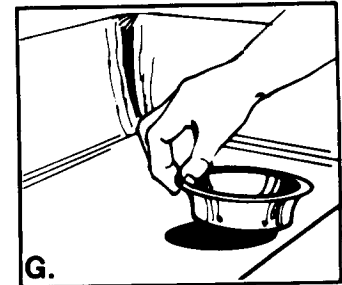

Finally, remove the old sink sleeve by pushing it up through the sink hole.

5 HERE IS WHAT YOU DO IF YOU ARE INSTALLING YOUR SINK'S FIRST DISPOSER.

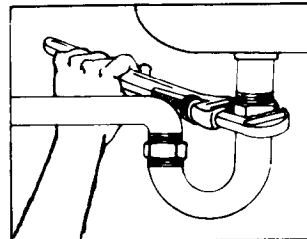

Use a wrench to loosen the nut at the top of the "P"-trap.

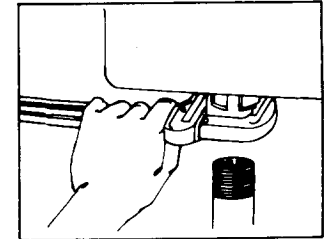

Next, remove the nut at the top of the sink strainer and remove the extension pipe.

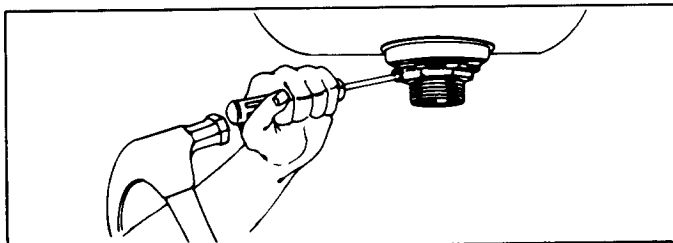

Now, remove the large-diameter nut at the base of the strainer by placing the tip of your screwdriver on the edge of the nut. (There are usually ridges to hold your screwdriver.)

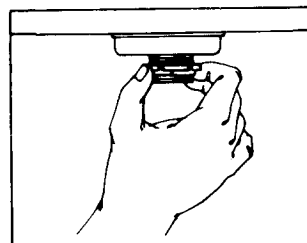

The nut should be loosened enough that you can spin it off by hand.

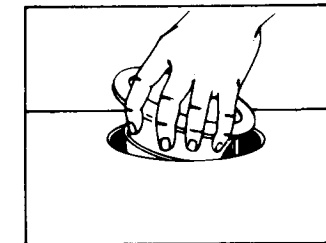

Now, push the strainer assembly up through the sink hole and remove it.

6

IF YOU ARE REPLACING AN OLD DISPOSER, CLEAN THE OLD SEALANT FROM THE RIM OF THE SINK HOLE.

Use your screwdriver or a putty knife to scrape away all traces of the old putty or caulking from the edge of the sink drain hole. Make sure you get this as clean as possible so that you'll have a good, water-tight seal for your new disposer sink sleeve.

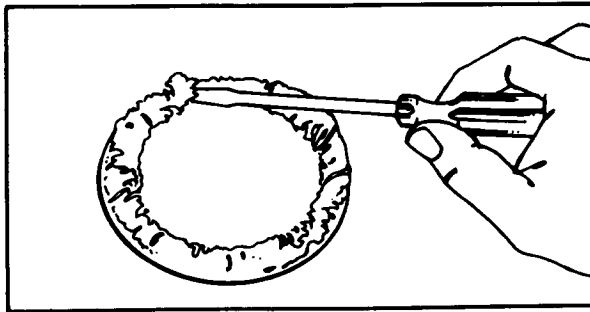

7

NOW, WE SEPARATE

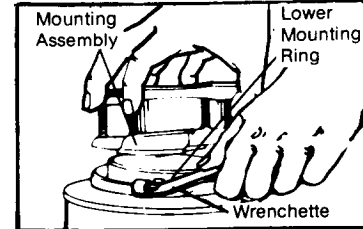

Start by disengaging the top mounting ring from the lower mounting ring. This is done by holding the top of the assembly with one hand and turning it clockwise while holding one of the mounting lugs with your other hand.

8

APPLY PUTTY TO THE SINK FLANGE.

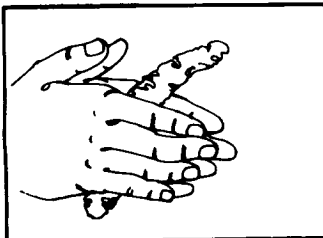

Buy 1/4 lb. of non-hardening "plumber's" putty at your hardware store. Make a nice fat snake of putty by rolling it between your hands.

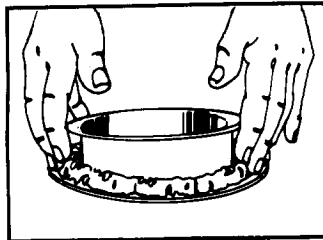

Apply this roll under the rim of the sink flange.

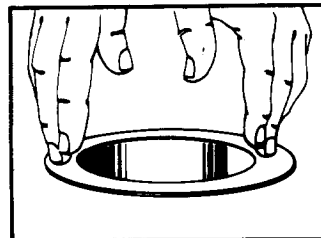

Then, place the sink's flange into the sink drain hole and push down gently but firmly to make sure it sits evenly in the putty.

9

NEXT, LE

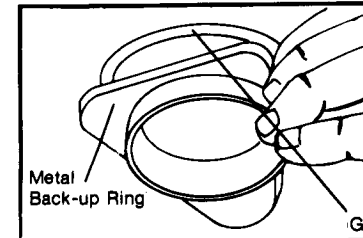

First, working from under the sink, push the fiber gasket and next the back-up ring (flat side up) up against the sink flange.

10

WE'RE READY TO MAKE THE ELECTRICAL CONNECTIONS.

Remove the electrical plate from the bottom of the disposer and pull out the two electrical wires. The ground screw is also under the plate.

Connect the wires from the switch to the disposer wires. In making this connection, electrical wire nuts can be used or wires may be securely soldered together. Be sure to connect white to white and black to black. Wrap wire connections with electrical tape and put wires inside of disposer housing. Check for proper grounding, then replace the electrical cover.

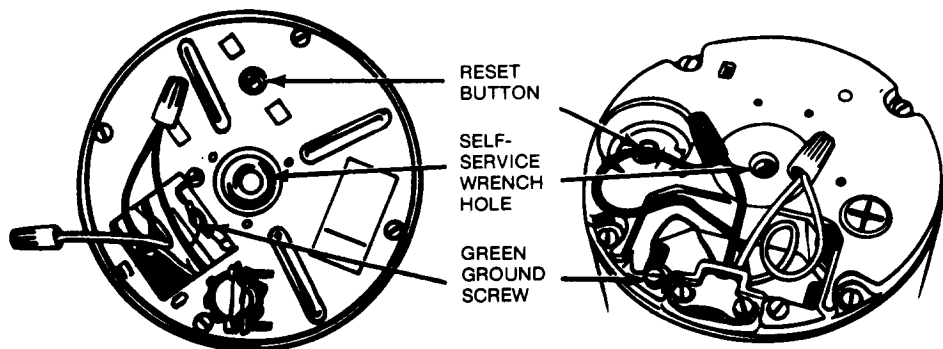

11



Simply a wire to the on the u

USE AND CARE OPERATING INSTRUCTIONS

1. Remove drain cover from disposer and turn on a full flow of cold water (Water should remain on during complete disposing operation). Failure to turn on a full flow of water before turning on the disposer can cause drain blockages.
2. Flip switch to ON position to start disposer. Feed food waste into disposer while it is operating.
3. To avoid drain pipe blockage allow water to flow sufficient time after grinding is completed to be sure all waste is flushed away. Ground waste

and water mixture flows at the rate of 2 seconds per foot in a horizontal drain line. A minimum of 15 seconds is recommended.

NOTE: After all the food waste has been fed into the disposer place the stopper in the sink sleeve in the drain/grind position (see illustrations) to minimize the possible ejection of material while grinding.

TO SEAL SINK FOR DISHWASHING . . . Press Stopper down. Remove for draining.

Replace stopper in drain position immediately (see figs. below) to minimize possible ejection of material while grinding.



Stopper is in drain/grind position.

Do's and Don'ts

DO grind food waste only with a strong flow of cold water.

DO grind hard material such as bones, fruit pits, etc. A scouring action is created by the particles inside of the grind chamber.

DO dispose of coffee grounds in your disposer regardless of whether you are on metropolitan sewer or septic tank. Coffee grounds will not harm the action of the septic tank.

DO dispose of small amounts of fats and greases in your disposer. Be sure to have the disposer operating and use a strong flow of cold water. If you have a large amount of fat and

grease, we suggest you place it in a container, allow it to solidify, then dispose of it in the trash.

DO flush disposer for self-cleansing. Allow disposer and cold water to run after grinding or after draining the sink of dish water. Some detergents are caustic; flushing will pass such material into the drain line without disposer injury.

DON'T use hot water when grinding food waste. However, hot water can be drained into the disposer between grinding periods.

DON'T turn off motor or water until grinding is

completed and only a motor and water sound is heard.

DON'T become alarmed if a brown discoloration appears on the face of the grinding disc. This is normal. It is a surface discoloration only and will not affect the life or performance of the disposer.

DON'T grind extremely fibrous material like corn husks, artichokes, etc. to avoid possible drain blockage.

If you should encounter an objectionable odor coming from your disposer, it may be the water itself, which in some areas develops a slight

odor at times. Or it may be coming from bits of food waste left inside the disposer, because the unit was turned off before the grind cycle was completed or not enough water was used. Try this remedy: after all remaining food waste is disposed of inside the unit:

Heat a large pan of water (approximately 3 to 4 quarts). To this add one-half cup of baking soda. Mix in thoroughly so it is completely dissolved. When water reaches approximate boiling point, turn disposer on and pour heated mixture into sink. This hot, swirling, treated water will then flush the inside of the disposer housing.

INSTRUCTIONS PERTAINING TO A RISK OF FIRE, ELECTRIC SHOCK, OR INJURY TO PERSONS

IMPORTANT SAFETY INSTRUCTIONS

WARNING: When using electric appliances, basic precautions should always be followed, including the following:

1. Read all the instructions before using the appliance.
2. To reduce the risk of injury, close supervision is necessary when an appliance is used near children.
3. Do not put fingers or hands into a waste disposer.
4. Turn the power switch to the off position before attempting to clear a jam or remove an object from the disposer.
5. When attempting to loosen a jam in a waste disposer, use a self service wrenchette as described below.
6. When attempting to remove objects from a waste disposer use a long-handled tongs or pliers.
7. To reduce the risk of injury by materials that may be expelled by a waste disposer, place the stopper in the drain/grind position when grinding. Do not put the following into a disposer:
 - a. Clam or oyster shells.
 - b. Drain cleaner.
 - c. Glass, china, or plastic.
 - d. Large whole bones.
 - e. Metal, such as bottle caps, tin cans, or aluminum foil.

8. When not operating a disposer, leave the drain cover in place to reduce the risk of objects falling into the disposer.

9. a. **GROUNDING INSTRUCTIONS FOR CORD CONNECTED UNITS.** This appliance must be grounded. In the event of a malfunction or breakdown, grounding provides a path of least resistance for electric current to reduce the risk of electric shock. If this appliance is equipped with a cord having an equipment-grounding conductor and a grounding plug, the plug must be plugged into an appropriate outlet that is properly installed and grounded in accordance with all local codes and ordinances.

DANGER - Improper connection of the equipment-grounding conductor can result in a risk of electric shock. Check with a qualified electrician or serviceman if you are in doubt as to whether the appliance is properly grounded. Do not modify the plug provided with the appliance — if it will not fit the outlet, have a proper outlet installed by a qualified electrician.

- b. **GROUNDING INSTRUCTIONS FOR PERMANENTLY CONNECTED UNITS:** This appliance must be connected to a grounded, metal, permanent wiring system; or an equipment-grounding conductor must be run with the circuit conductors and connected to the equipment-grounding terminal or lead on the appliance.

SAVE THESE INSTRUCTIONS.

USER MAINTENANCE INSTRUCTIONS

Trouble Shooting

Loud noises while your disposer is operating are usually caused by the accidental entry of a spoon, bottle cap, or similar object. To correct this, turn off the disposer switch and water. After grinding disc has stopped turning, investigate. Remove object, by reaching into the unit with tongs.

Motor stops while your disposer is operating. This can be caused by overloading the unit.

First, check the cause of the overload—often some foreign material is in the disposer. Turn off the disposer switch and water. Remove object as previously explained. **TO RESTART THE MOTOR:** wait 3 to 5 minutes, then push in on the small red reset button located on the bottom of your disposer (figure 4). If motor remains inoperative, check your fuse box and replace any blown fuses, or look for a tripped

circuit breaker.

Note: If water does not drain as readily as you think it should, and food waste tends to float or take too long to grind, don't reduce water flow to solve this problem. It is very likely that the drain line is partially clogged and should be cleaned with a plumber's flexible rod or tape.

Like any precision machine, your disposer was built to perform a particular job. If unusual demands are placed on it, service interruptions are possible. These service interruptions, mentioned below, are usually not serious and in most cases, can be remedied without calling a service man.

To Free Jams From Foreign Objects

The accidental entry of foreign material will cause any disposer to jam occasionally. To free jammed material, follow these steps:

1. Turn off disposer and shut off cold water.
2. Insert one end of your Self Service Wrench provided with your disposer, into the center hole of the bottom of the disposer as shown.
3. Work the Wrench back and forth until it moves freely for at least one complete revolution. Remove foreign object with tongs. Remove Wrench before restarting disposer.
4. Wait 3 to 5 minutes to allow disposer motor to cool and then push red reset button (see fig. 4).

Your Self Service Wrench will free virtually every jam that may occur, due to foreign objects entering the disposer. Very rarely, however, a piece of metal (bobby pin, thumb tack, paper clip, silverware, etc.) causes a jammed condition too tight for your Wrenchette to handle. To free this type of jam, a pry bar or tool must be used.

Follow this procedure to save the cost of a service call to free a tight jam:

Be sure wall switch is turned off. Remove as much food waste from the disposer as is possible reaching with tongs. Use a flashlight to determine the direction the unit was running at the time of the jam. A pry bar or tool should be inserted through the sink opening into the

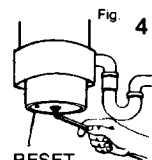

RESET BUTTON

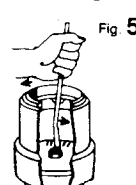

disposer. The end then must be placed alongside the grinding protrusion near the outside edge of the grinding disc. Be sure to place the pry tool on the proper side of the protrusion so when pressure is applied the grinding disc will move in

the proper direction to unjam the disposer (see figure 5).

Do not drop or hammer on pry bar.

Lose Your Self Service Wrenchette? If you should ever lose your Self Service Wrench just write to us and a replacement will be sent at no charge.

WRITE TO: JENN-AIR
3035 SHADELAND AVE.
INDIANAPOLIS, IN
46226