

CONSERVATOR[®]
By CROSLEY

**120-VOLT COMPACT
ELECTRIC DRYER**

Use & Care Guide

For questions about features, operation/performance,
parts, accessories or service call: **1-800-253-1301**
or visit our website at
www.crosley.com

Table of Contents.....2

TABLE OF CONTENTS

DRYER SAFETY	3
PARTS AND FEATURES	4
INSTALLATION INSTRUCTIONS	5
Tools and Parts	5
Location Requirements	5
Electrical Requirements	7
Venting Requirements.....	7
Determine Vent Length	8
Begin Installation.....	8
Install Vent System.....	9
Connect Vent	9
Complete Installation	10
DRYER USE	10
Starting Your Dryer	10
Stopping and Restarting	11
Loading Clothes	11
Drying, Cycle, and Temperature Tips	11
CYCLE DESCRIPTIONS	12
Permanent Press Cycle	12
Timed Dry Cycle.....	12
Air Cycle	12
End of Cycle Signal.....	12
DRYER CARE	13
Cleaning the Lint Screen.....	13
Cleaning the Dryer Interior	13
Removing Accumulated Lint from Inside the Dryer Cabinet	13
TROUBLESHOOTING	14
ASSISTANCE OR SERVICE	15
WARRANTY	16

DRYER SAFETY

Your safety and the safety of others are very important.

We have provided many important safety messages in this manual and on your appliance. Always read and obey all safety messages.



This is the safety alert symbol.

This symbol alerts you to potential hazards that can kill or hurt you and others.

All safety messages will follow the safety alert symbol and either the word "DANGER" or "WARNING." These words mean:

⚠ DANGER

You can be killed or seriously injured if you don't immediately follow instructions.

⚠ WARNING

You can be killed or seriously injured if you don't follow instructions.

All safety messages will tell you what the potential hazard is, tell you how to reduce the chance of injury, and tell you what can happen if the instructions are not followed.

IMPORTANT SAFETY INSTRUCTIONS

WARNING: To reduce the risk of fire, electric shock, or injury to persons when using the dryer, follow basic precautions, including the following:

- Read all instructions before using the dryer.
- Do not place items exposed to cooking oils in your dryer. Items contaminated with cooking oils may contribute to a chemical reaction that could cause a load to catch fire.
- Do not dry articles that have been previously cleaned in, washed in, soaked in, or spotted with gasoline, dry-cleaning solvents, other flammable, or explosive substances as they give off vapors that could ignite or explode.
- Do not allow children to play on or in the dryer. Close supervision of children is necessary when the dryer is used near children.
- Before the dryer is removed from service or discarded, remove the door to the drying compartment.
- Do not reach into the dryer if the drum is moving.
- Do not install or store the dryer where it will be exposed to the weather.
- Do not tamper with controls.
- Do not repair or replace any part of the dryer or attempt any servicing unless specifically recommended in this Use and Care Guide or in published user-repair instructions that you understand and have the skills to carry out.
- Do not use fabric softeners or products to eliminate static unless recommended by the manufacturer of the fabric softener or product.
- Do not use heat to dry articles containing foam rubber or similarly textured rubber-like materials.
- Clean lint screen before or after each load.
- Keep area around the exhaust opening and adjacent surrounding areas free from the accumulation of lint, dust, and dirt.
- The interior of the dryer and exhaust vent should be cleaned periodically by qualified service personnel.
- See Installation Instructions for grounding requirements.

SAVE THESE INSTRUCTIONS

PARTS AND FEATURES

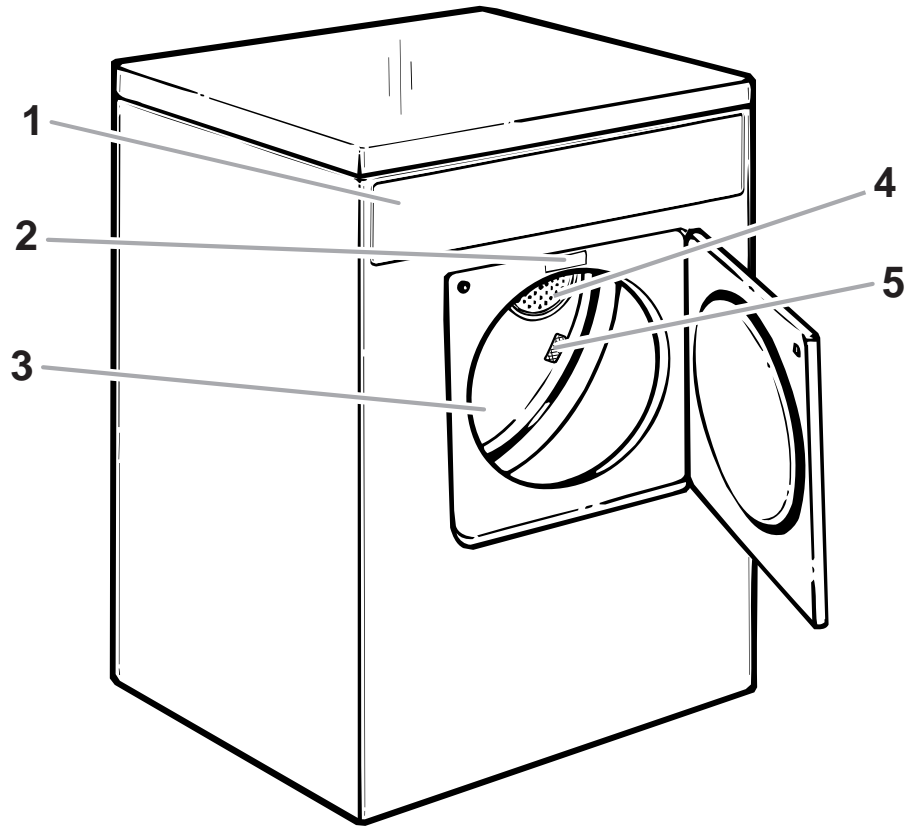

1. Control panel
2. Model and serial number label
3. Dryer drum
4. Lint screen
5. Moisture sensor

Control Panel

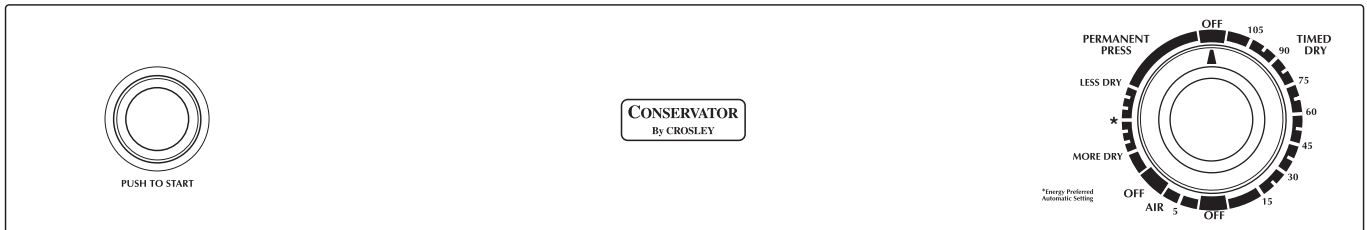

INSTALLATION INSTRUCTIONS

Tools and Parts

Tools needed

Check that you have everything necessary for correct installation. Proper installation is your responsibility.

- flat bladed screwdriver
- level
- adjustable wrench
- gloves (optional)
- tin snips (new vent installations)
- safety glasses (optional)
- duct tape
- caulking gun and compound (for installing new exhaust vent)

1. Remove the tape that holds the drum to the cabinet. Move the drum by hand in a counter-clockwise direction to make certain all tape has been removed.
2. Wipe the interior of the drum thoroughly with a damp cloth before using the dryer.

Parts supplied

Remove parts package from the dryer drum. Check that all parts listed were included.

- 1 - cycle control (timer) knob
- 1 - Push to Start button
- 4 - casters
- 2 - cord brackets
- 2 - screws

Parts needed

Check local codes, check existing electrical supply and venting, and see “Venting Requirements” and “Electrical Requirements” before purchasing parts.

Location Requirements

⚠ WARNING



Explosion Hazard

Keep flammable materials and vapors, such as gasoline, away from dryer.

Place dryer at least 18 inches (46 cm) above the floor for a garage installation.

Failure to do so can result in death, explosion, or fire.

Check location where dryer will be installed. Proper installation is your responsibility.

You will need

- A location that allows for proper exhaust installation. See “Venting Requirements.”
- A grounded electrical supply is required. See “Electrical Requirements.”
- 4-inch metal exhaust vent is required. See “Venting Requirements.”
- A sturdy floor to support the total dryer weight of 110 lb (50 kg).
- Location must be large enough to fully open dryer door.
- A level floor with a maximum slope of 1 in. (2.5 cm) under entire dryer. Clothes may not tumble properly and automatic sensor cycles may not operate correctly if dryer is not level.

Do not operate your dryer at temperatures below 45°F (7°C). At lower temperatures, the dryer might not shut off at the end of an automatic cycle. Drying times can be extended. Do not store your dryer in a location with year round temperatures below 45°F (7°C).

Install the dryer where it is protected from water and/or weather.

Check code requirements. Some codes limit, or do not permit, installation of the dryer in garages, closets, mobile homes, or sleeping quarters. Contact your local building inspector.

WARNING: To reduce the risk of fire, this appliance **MUST BE EXHAUSTED OUTDOORS.**

Recommended/Minimum Clearances

Most installations require a minimum 5 in. (12.7 cm) clearance behind the dryer for the exhaust vent with elbows. See “Venting Requirements.”

NOTE: Observe all governing codes and ordinances.

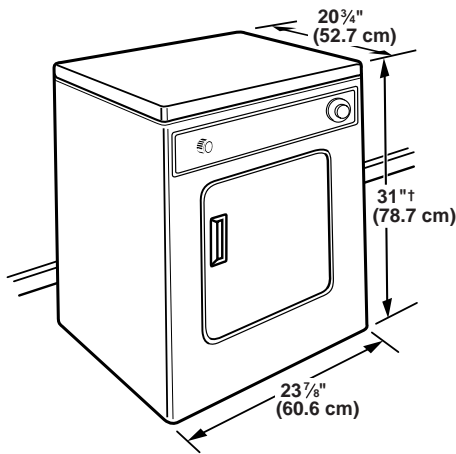

†Height with casters is 32 1/2" (82.6 cm).

- Additional spacing should be considered for ease of installation and servicing.
- Additional clearances might be required for wall, door, and floor moldings.
- Additional spacing of 1 in. (2.5 cm) on all sides of the dryer is recommended to reduce noise transfer.
- For closet installation with a door, minimum ventilation openings in the top and bottom of the door are required. Louvered doors with equivalent ventilation openings are acceptable.
- Companion appliance spacing should also be considered.

NOTE: No fuel-burning appliances may be installed in the same closet as a dryer.

Mobile Home-Additional Location Requirements

This dryer is suitable for mobile home installations. Follow the information in “Location Requirements.”

The installation must conform to the Manufactured Home Construction and Safety Standard, Title 24 CFR, Part 3280 (formerly the Federal Standard for Mobile Home Construction and Safety, Title 245, HUD Part 280).

Recessed Area and Closet Installation

Your dryer needs a certain amount of space around it for proper ventilation and for easier installation and servicing. The following minimum installation spacings are required when the unit is to be operated with, or without, the Stack Stand Kit. To purchase a Stack Stand Kit, see “Assistance or Service.”

Minimum installation spacing

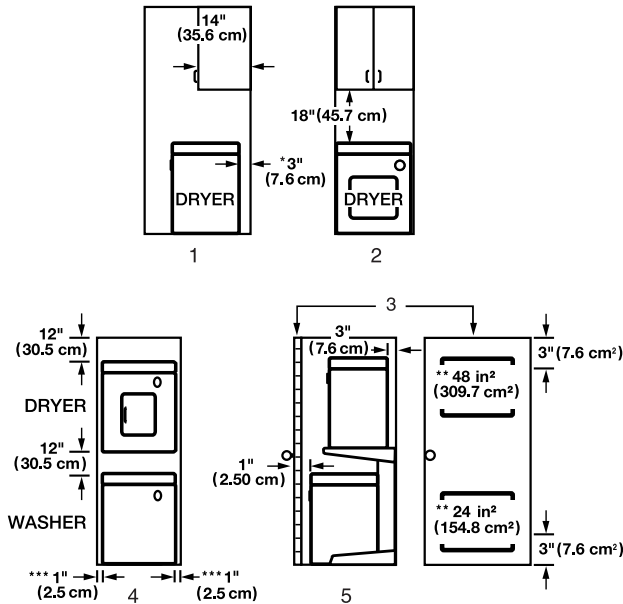

1. Side
2. Front
3. Closet door
4. Front—stack stand
5. Side—stack stand

* Additional space may be needed for exhaust elbow

** Opening is minimum for closet door. Louvered door with air opening is acceptable.

*** May be 0" (0 cm) clearance

Electrical Requirements

⚠ WARNING



Electrical Shock Hazard

Plug into a grounded 3 prong outlet.

Do not remove ground prong.

Do not use an adapter.

Do not use an extension cord.

Failure to follow these instructions can result in death, fire, or electrical shock.

- A 120-volt, 60-Hz., AC-only, 15- or 20- ampere fused electrical supply is required.
- A time-delay fuse or circuit breaker is recommended. Be sure fuse or circuit breaker matches the rating of your line.
- Use a separate circuit serving only your dryer.
- Do not use an extension cord

GROUNDING INSTRUCTIONS

■ For a grounded, cord-connected dryer:
This dryer must be grounded. In the event of malfunction or breakdown, grounding will reduce the risk of electric shock by providing a path of least resistance for electric current. This dryer is equipped with a cord having an equipment-grounding conductor and a grounding plug. The plug must be plugged into an appropriate outlet that is properly installed and grounded in accordance with all local codes and ordinances.

WARNING: Improper connection of the equipment-grounding conductor can result in a risk of electric shock. Check with a qualified electrician or service representative or personnel if you are in doubt as to whether the dryer is properly grounded. Do not modify the plug provided with the dryer: if it will not fit the outlet, have a proper outlet installed by a qualified electrician.

SAVE THESE INSTRUCTIONS

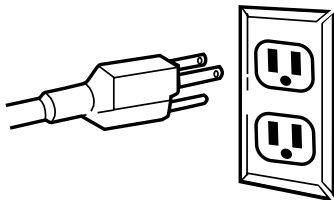

Venting Requirements

⚠ WARNING



Fire Hazard

Use a heavy metal vent.

Do not use a plastic vent.

Do not use a metal foil vent.

Failure to follow these instructions can result in death or fire.

WARNING: To reduce the risk of fire, this dryer **MUST BE EXHAUSTED OUTDOORS.**

- Do not exhaust the dryer into any gas vent, chimney, wall, ceiling, or a concealed space of a building.
- The diameter of the heavy metal exhaust vent must be 4 in. (10.2 cm).
- Do not use an exhaust hood with a magnetic latch.
- Do not install flexible metal vent in enclosed walls, ceilings or floors.
- Do not use screws or other fastening devices that extend into the interior of the vent to secure vent.

IMPORTANT: Observe all governing codes and ordinances.

Improper venting can cause moisture and lint to collect indoors, which may result in:

- Moisture damage to woodwork, furniture, paint, wall-paper, carpets, etc.
- Housecleaning problems and health problems.

Use a heavy metal vent. Do not use plastic or metal foil vent.

Rigid metal vent is recommended to prevent crushing and kinking.

Flexible metal vent must be fully extended and supported when the dryer is in its final position. Remove excess flexible metal vent to avoid sagging and kinking that may result in reduced air flow.

An exhaust hood should cap the vent to prevent rodents and insects from entering the home.

Exhaust hood must be at least 12 in. (30.5 cm) from the ground or any object that may be in the path of the exhaust (such as flowers, rocks or bushes, etc.).

If using an existing vent system, clean lint from the entire length of the system and make sure exhaust hood is not plugged with lint. Lint should be removed again every 2 years, or more often, depending on dryer usage. Replace any plastic or metal foil vent with rigid metal or flexible metal vent.

Use duct tape to seal all joints.

Determine Vent Length

NOTE: Check periodically to ensure that the outside exhaust hood is not blocked.

The maximum length of the exhaust system depends upon:

- The type of vent (rigid metal or flexible metal).
- The number of elbows (90° turns) used.

Recommended hood styles are shown here.

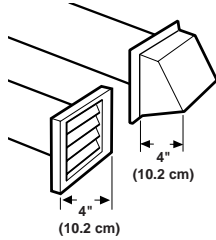

1. Box hood style
2. Louvered hood style

The angled hood style (shown following) is acceptable.

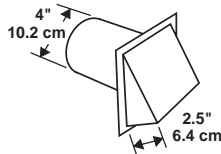

See the exhaust vent length chart that matches your hood type for the maximum vent lengths you can use.

Do not use vent runs longer than specified in exhaust vent length charts.

Exhaust systems longer than specified will:

- Shorten the life of the dryer.
- Reduce performance, resulting in longer drying times and increased energy usage.

Determine the number of elbows you will need. In the column listing the type of metal vent you are using (rigid metal or flexible metal); find the maximum length of metal vent on the same line as the number of elbows

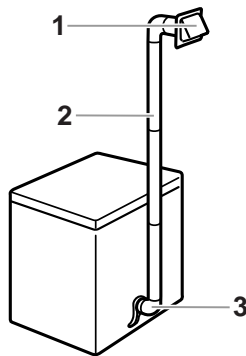

1. Exhaust hood
2. Flexible metal vent or rigid metal vent
3. Elbow

Vent Length Chart

Number of 90° turns or elbows	Type of vent	Box or louvered hoods	Angled hoods
0	Rigid metal	36 ft (11 m)	26 ft (7.9 m)
	Flexible metal	28 ft (8.5 m)	22 ft (6.7 m)
1	Rigid metal	26 ft (7.9 m)	16 ft (4.9 m)
	Flexible metal	18 ft (5.5 m)	12 ft (3.7 m)
2	Rigid metal	16 ft (4.9 m)	6 ft (1.8 m)
	Flexible metal	8 ft (2.8 m)	2 ft (.6 m)

Special Venting Information for Mobile Homes

The exhaust vent must be securely fastened to a noncombustible portion of the mobile home structure.

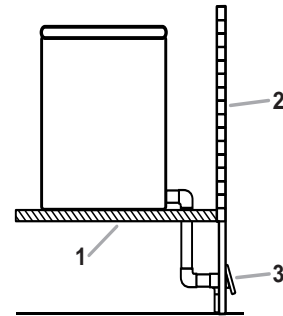

1. Floor
2. Outside wall
3. Enclosure

Terminate the exhaust vent outside. The exhaust vent must not terminate beneath the mobile home and must not be connected to any other duct, vent, or chimney.

Begin Installation

Do not move dryer into its final position until the following steps have been performed.

! WARNING

Excessive Weight Hazard

Use two or more people to move and install dryer.

Failure to do so can result in back or other injury.

Install cord bracket

3. Remove tape from the power cord and the rear panel.

4. Insert cord brackets into slotted holes in rear panel and secure with screws provided.

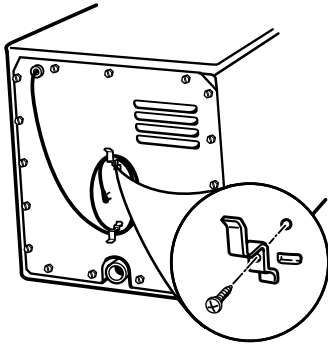

NOTE: Power supply cord may be wrapped around the brackets for storage convenience when dryer is not in use.

Install casters

1. Lay the dryer on its side.
2. Use the carton to prevent damage to the dryer.

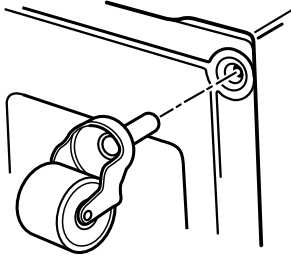

3. Screw casters into dryer base at four corners and tighten securely.
4. Set the dryer upright. In doing so, be careful that the dryer does not roll away from you.
 - As stated in "Location Requirements", it is important that the dryer be located on a level surface.
 - Leveling feet (Part No. 51594200) for use in permanent installations may be purchased. See "Assistance or Service."

Install Vent System

1. (Optional) Put on safety glasses and gloves.
2. Before installing the vent system, be sure to remove the wire exhaust guard that is located at the exhaust outlet.

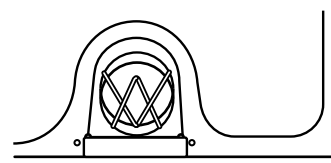

3. Install exhaust hood. Use caulking compound to seal exterior wall opening around exhaust hood.
4. Connect vent to exhaust hood. Vent must fit inside exhaust hood. Secure vent to exhaust hood with 4 in. (10.2 cm) clamp.
5. Run vent to dryer location. Use the straightest path possible. See "Determine Vent Length". Avoid 90° turns. Use duct tape to seal all joints.

Connect Vent

1. Using a 4 in. (10.2 cm) clamp, connect vent to exhaust outlet in dryer. If connecting to existing vent, make sure the vent is clean. The dryer vent must fit over the dryer exhaust outlet and inside the exhaust hood. Make sure the vent is secured to exhaust hood with a 4 in. (10.2 cm) clamp.
2. Move dryer into final position. Do not crush or kink vent. Make sure dryer is level.

Complete Installation

1. Check to be sure all parts are now installed. If there is an extra part, go back through the steps to see which step was skipped.
2. Check to be sure you have all of your tools.
3. Dispose of all packaging materials.
4. Check the dryer's final location. Be sure the vent is not crushed or kinked.
5. Check to be sure the dryer is level.
6. Plug into a grounded 3 prong outlet.
7. Remove the blue protective film on the console and any tape remaining on the dryer.
8. Read "Dryer Use."
9. Wipe the dryer drum interior thoroughly with a damp cloth to remove any dust.
10. Set the dryer on a full heat cycle (not the Air cycle) for 20 minutes. Open the dryer door after five minutes and feel for heat. If you do not feel heat, turn the dryer off and wait five minutes.

Then check the following:

- Controls are set in a running or "On" position.
- Start button has been pushed firmly.

Repeat 5-minute test as outlined above. If dryer still does not operate properly, check the following:

- Dryer is plugged into a grounded outlet.
- Electrical supply is connected.
- House fuse is intact and tight; or circuit breaker has not tripped.
- Dryer door is closed.
- If dryer makes an unusual noise, check that dryer is level.

NOTE: You may notice a burning odor. This odor is common when the heating element is first used. The odor will go away.

DRYER USE

Starting Your Dryer

⚠ WARNING



Explosion Hazard

Keep flammable materials and vapors, such as gasoline, away from dryer.

Do not dry anything that has ever had anything flammable on it (even after washing).

Failure to follow these instructions can result in death, explosion, or fire.

⚠ WARNING



Fire Hazard

No washer can completely remove oil.

Do not dry anything that has ever had any type of oil on it (including cooking oils).

Items containing foam, rubber, or plastic must be dried on a clothesline or by using an Air Cycle.

Failure to follow these instructions can result in death or fire.

Before using your dryer, wipe the dryer drum with a damp cloth to remove dust from storing and shipping.

1. Load clothes loosely into the dryer and close the door. Do not pack the dryer. Allow space for clothes to tumble freely.

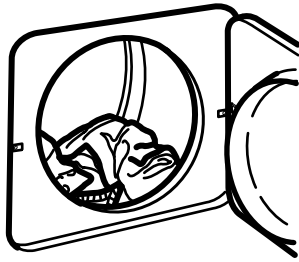

2. Turn the Cycle Control knob to the recommended cycle for the type of load being dried. Use the Energy Preferred Automatic Setting (*) to dry most heavyweight and medium weight loads. See “Drying, Cycle, and Temperature Tips.”

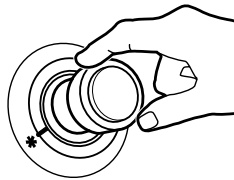

3. Push the START button.

Stopping and Restarting

You can stop your dryer any time during a cycle.

To stop your dryer

Open the dryer door or turn the Cycle Control knob to OFF.

NOTE: The Cycle Control knob should point to an Off area when the dryer is not in use.

To restart your dryer

1. Close the door.
2. Select a new cycle (if desired).
3. Push START.

Loading Clothes

Load clothes loosely into the dryer. Do not pack the dryer. Allow space for clothes to tumble freely. The following chart shows the maximum load you can place in your compact dryer. Expect longer drying times.

Heavy work clothes	2 pair of pants, 3 work shirts
Delicates	1 camisole, 2 slips, 4 undergarments, 1 set of sleepwear, 1 half slip
Towels	9 bath towels; or 6 bath towels, 3 hand towels, 6 wash cloths
Mixed Load	2 pillowcases, 1 T-shirt, 2 shirts, 1 pair slacks
Knits	2 slacks, 2 shirts; or 3 dresses
Perm. Press	6 shirts; or 2 double sheets & 2 pillowcases; or 2 singles sheets & 2 pillowcases

Drying, Cycle, and Temperature Tips

Select the correct cycle and temperature for your load.

Your dryer tumbles the load without heat during the last few minutes of all cycles to make the load easier to handle.

Drying tips

- Follow care label directions when they are available.
- If you use fabric softener sheets, use only those labeled “dryer safe.” Follow package instructions.
- Remove the load from the dryer as soon as tumbling stops to reduce wrinkling. This is especially important for permanent press, knits, and synthetic fabrics.

Cycle and temperature tips

- Dry most loads using the Energy Preferred Automatic Setting (*).
- Use a no heat (air) setting for rubber, plastic, or heat sensitive fabrics.
- Line dry bonded or laminated fabrics.

NOTE: If you have questions about drying temperatures for various loads, refer to the care label directions.

CYCLE DESCRIPTIONS

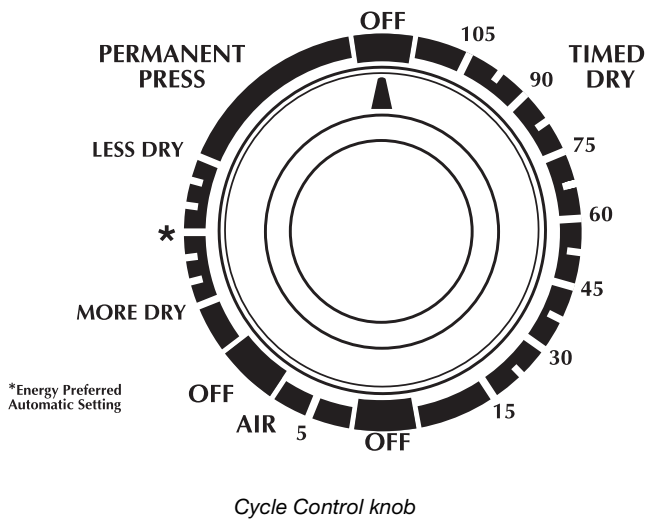

Permanent Press Cycle

This automatic cycle shuts off the dryer when the selected dryness is reached. The Cycle Control knob does not move until the load is almost dry. After the cool down, the knob automatically turns to an Off area and tumbling stops.

Dry most loads using the Energy Preferred Automatic Setting (*).

- If the load is drier than you like, select a setting closer to Less Dry the next time you dry a similar load.
- If the load is not as dry as you like, complete drying using the Timed Dry cycle. The next time you dry a similar load, select a setting closer to More Dry.

NOTE: Drying time with an automatic cycle varies according to the type of fabric, size of load, and temperature setting.

Timed Dry Cycle

Use this cycle to complete drying if items are still damp after the automatic cycle.

Timed Drying is also useful for:

- Heavyweight items and work clothes that require a long drying time.
- Lightweight items, such as lingerie, blouses, and knits that require a short drying time.

For damp dry, turn the Cycle Control knob to 30 minutes or less.

Air Cycle

Use this cycle for items that require drying without heat, such as rubber, plastic, and heat-sensitive fabrics. See the chart for examples of items that can be dried using an air cycle.

Type of Load	Time*
Foam rubber—pillows, padded bras, stuffed toys	20 - 30
Plastic—shower curtains, tablecloths	20 - 30
Rubber-backed rugs	40 - 50
Olefin, polypropylene, sheer nylon	10 - 20

*(Minutes). Reset cycle to complete drying, if needed.

When using an air cycle

- Check to see that coverings are securely stitched.
- Shake and fluff pillows by hand periodically during cycle.
- Dry item completely. Foam rubber pillows are slow to dry.

End of Cycle Signal

The dryer sounds a signal to let you know when the cycle is finished. The signal is not adjustable and cannot be turned off. The signal is helpful when you are drying permanent press, synthetics, and other items that should be taken out as soon as the dryer stops.

DRYER CARE

Cleaning the Lint Screen

Every load cleaning

The lint screen is located inside the dryer drum, on the back wall. Clean it before each load. A screen blocked by lint can increase drying time.

To clean

1. Open the door and pull the lint screen straight out.

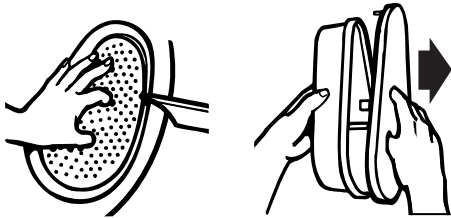

2. Squeeze body of lint screen lightly while pulling off the cover.
3. Roll lint off the screen with your fingers. Do not rinse or wash screen to remove lint. Wet lint is hard to remove.
4. Replace cover on lint screen body. Push the lint screen firmly back into place and close the door.

IMPORTANT:

- Do not run the dryer with the lint screen loose, damaged, blocked, or missing. Doing so can cause overheating and damage to both the dryer and fabrics.
- Some towels made of synthetic fibers and natural fibers (polyester and cotton blends) may shed more lint than other towels, causing your dryer's lint screen to fill up faster. Be sure to remove lint from the lint screen before and after drying new towels.

As needed cleaning

Laundry detergent and fabric softener residue can build up on the lint screen. This buildup can cause longer drying times for your clothes, or cause the dryer to stop before your load is completely dry. The screen is probably clogged if lint falls off the screen.

Clean the lint screen with a nylon brush every six months, or more frequently if it becomes clogged due to a residue buildup.

To wash

1. Wet both the lint screen cover and body with hot water.
2. Wet a nylon brush with hot water and liquid detergent. Scrub lint screen cover and body with the brush to remove residue buildup.



3. Rinse with hot water.
4. Thoroughly dry lint screen body and cover with a clean towel. Replace in dryer.

Cleaning the Dryer Interior

! WARNING



Explosion Hazard

Use nonflammable cleaner.

Failure to do so can result in death, explosion, or fire.

To clean dryer drum

1. Make a paste with powdered laundry detergent and very warm water.
2. Apply paste to a soft cloth.

OR

Apply a liquid, non-flammable household cleaner to the stained area and rub with a soft cloth until all excess dye is removed.

3. Wipe drum thoroughly with a damp cloth.
4. Tumble a load of clean cloths or towels to dry drum.

NOTE: Garments which contain unstable dyes, such as denim blue jeans or brightly colored cotton items, may discolor the dryer interior. These stains are not harmful to your dryer and will not stain future loads of clothes. Dry unstable dye items inside-out to prevent dye transfer.

Removing Accumulated Lint from Inside the Dryer Cabinet

Lint should be removed every two years, or more often, depending on dryer usage. Cleaning should be done by a qualified person.

TROUBLESHOOTING

First try the solutions suggested here and possibly avoid the cost of a service call...

Clothes are not drying satisfactorily

- **The compact dryer operates at a lower wattage. Expect longer drying times.**

- **Check the following:**

Is the wire exhaust guard removed from the back of the dryer?

Is the lint screen clogged with lint?

Is the exhaust vent or outside exhaust hood clogged with lint, restricting air movement? Run the dryer for 5-10 minutes. Hold your hand under the outside exhaust hood to check air movement. If you do not feel air movement, clean exhaust system of lint or replace exhaust vent with heavy metal or flexible metal vent. See "Installation Instructions."

Is the exhaust vent crushed or kinked? Replace with heavy metal or flexible metal vent. See "Installation Instructions."

Has an air dry cycle been selected? Select the right cycle for the types of garments being dried. See "Drying, Cycle, and Temperature Tips."

Are fabric softener sheets blocking the grill? Use only one fabric softener sheet and only use it once.

Is the automatic cycle ending early? This cycle will end early if dryer load is not contacting the sensor strips. Level the dryer. See "Installation Instructions."

- **Is the dryer located in a room with temperature below 45°F (7°C)?**
Proper operation of dryer cycles requires temperatures above 45°F (7°C).
 - **Was a cold rinse water used? Was the load very wet?**
Expect longer drying times with items rinsed in cold water and with items that hold moisture (cottons).
 - **Is the load too large and heavy to dry quickly?**
Separate the load to tumble freely.
-

Dryer will not run

- **Check the following:**
Is the power cord plugged into a grounded 3 prong outlet?
Has a fuse blown, or has a circuit breaker tripped?
Was a regular fuse used? Use a time-delay fuse.
Is the dryer door firmly closed?
Was the START button firmly pressed?
Is a cycle selected?
-

Unusual sounds

- **Has the dryer had a period of non-use?**
If the dryer hasn't been used for a while, there may be a thumping sound during the first few minutes of operation.
-

Lint on load

- **Is the lint screen clogged?**
Clean lint screen. Check for air movement.
 - **Is the load properly sorted?**
Sort lint givers (towels, chenille) from lint takers (corduroy, synthetics). Also sort by color.
 - **Is the load too big or too heavy?**
Dry smaller loads so lint can be carried to the lint screen.
 - **Was the load overdried?**
Use correct dryer settings for load type. Overdrying can cause lint-attracting static electricity. See "Drying, Cycle, and Temperature Tips."
 - **Was paper or tissue left in pockets?**
 - **Is pilling being mistaken for lint?**
Pilling (surface fuzz) is caused by normal wear and laundering.
-

Stains on load or color change

- **Was dryer fabric softener properly used?**
Add dryer fabric softener sheets at the beginning of the cycle. Fabric softener sheets added to a partially-dried load can stain your garments.
 - **Were items soiled when placed in the dryer?**
Items should be clean before being dried.
 - **Were items properly sorted?**
Sort light colors from dark colors. Sort colorfast items from noncolorfast items.
-

Items shrinking

- **Was the dryer overloaded?**
Dry smaller loads that can tumble freely.
 - **Did the load overdry?**
Check the manufacturer's care label. Match dryer setting to load type. See "Drying, Cycle, and Temperature Tips."
-

Loads are wrinkled

- **Was the load removed from dryer at the end of the cycle?**
 - **Was the dryer overloaded?**
Dry smaller loads that can tumble freely.
 - **Did the load overdry?**
Check the manufacturer's care label. Match dryer setting to load type. See "Drying, Cycle, and Temperature Tips."
-

Odors

- **Have you recently been painting, staining, or varnishing in the area where your dryer is located?**
If so, ventilate the area. When the odors or fumes are gone from the area, re-wash and dry the clothing.
 - **Is the dryer being used for the first time?**
The new electric heating element may have an odor. The odor will be gone after the first cycle.
-

Garment damage

- **Check the following:**
Were zippers, snaps, and hooks left open?
Were strings and sashes tied to prevent tangling?
Were care label instructions followed?
Were items damaged before drying?
-

ASSISTANCE OR SERVICE

Before calling for assistance or service, please check “Troubleshooting.” It may save you the cost of a service call. If you still need help, follow the instructions below.

When calling, please know the purchase date and the complete model and serial number of your appliance. This information will help us to better respond to your request.

If you need replacement parts

If you need to order replacement parts, we recommend that you only use Factory Specified Parts. These parts will fit right and work right because they are made with the same precision used to build every new CROSLEY® appliance. To locate replacement parts in your area, call our Customer Interaction Center or your nearest designated service center.

For assistance or service

Call the Customer Interaction Center at **1-800-253-1301**.

Our consultants provide assistance with:

- Features and specifications on our full line of appliances
- Installation information
- Use and maintenance procedures
- Accessory and repair parts sales
- Specialized customer assistance (Spanish speaking, hearing impaired, limited vision, etc.)
- Referrals to local dealers, repair parts distributors, and service companies

Whirlpool designated service technicians are trained to fulfill the product warranty and provide after-warranty service, anywhere in the United States.

To locate the Whirlpool designated service company in your area, you can also look in your telephone directory Yellow Pages.

For further assistance

If you need further assistance, you can write to us with any questions or concerns at:

Crosley Distribution Center
c/o Correspondence Dept.
675 North Main Street
Winston-Salem, NC 27102-2111

Please include a daytime phone number in your correspondence.

CROSLEY® DRYER WARRANTY

ONE-YEAR FULL WARRANTY

For one year from the date of purchase, when this dryer is operated and maintained according to instructions attached to or furnished with the product, Whirlpool Corporation will pay for Factory Specified Parts and repair labor to correct defects in materials or workmanship. Service must be provided by a Whirlpool designated service company.

Whirlpool Corporation will not pay for:

1. Service calls to correct the installation of your dryer, including venting. Heavy 4 in. (10.2 cm) metal exhaust vent must be used. Refer to the venting section of this manual and your Installation Instructions.
 2. Service calls to instruct you how to use your dryer, to replace house fuses or correct house wiring or reset circuit breakers, or to replace owner accessible light bulbs.
 3. Repairs when your dryer is used in other than normal, single-family household use.
 4. Damage resulting from accident, alteration, misuse, abuse, fire, floods, acts of God, improper installation (including, but not limited to, venting with plastic or flexible foil), installation not in accordance with local electrical and plumbing codes, or use of products not approved by Whirlpool Corporation.
 5. Replacement parts or repair labor costs for units operated outside the United States.
 6. Pickup and delivery. This product is designed to be repaired in the home.
 7. Repairs to parts or systems resulting from unauthorized modifications made to the appliance.
-

WHIRLPOOL CORPORATION SHALL NOT BE LIABLE FOR INCIDENTAL OR CONSEQUENTIAL DAMAGES.

Some states do not allow the exclusion or limitation of incidental or consequential damages, so this exclusion or limitation may not apply to you. This warranty gives you specific legal rights, and you may also have other rights which may vary from state to state.

Outside the 50 United States, this warranty does not apply. Contact your authorized Crosley dealer to determine if another warranty applies.

If you need service, first see "Troubleshooting." Additional help can be found by checking "Assistance or Service," or by calling our Customer Interaction Center at **1-800-253-1301**, from anywhere in the U.S.A., or write: Crosley Distribution Center, c/o Correspondence Dept., 675 N. Main St., Winston-Salem, NC 27102-2111.

5/00

Keep this book and your sales slip together for future reference. You must provide proof of purchase or installation date for in-warranty service.

Write down the following information about your dryer to better help you obtain assistance or service if you ever need it. You will need to know your complete model number and serial number. You can find this information on the model and serial number label/plate, located on your appliance as shown in "Parts and Features."

Dealer name _____
Address _____
Phone number _____
Model number _____
Serial number _____
Purchase date _____