



GAS RANGE

Use & Care Guide

For questions about features, operation/performance parts, accessories or service, call: **1-800-253-1301**.

In Canada, call for assistance **1-800-461-5681**, for installation and service, call: **1-800-807-6777**

or visit our website at...
www.whirlpool.com or www.whirlpool.com/canada

Table of Contents	2
-------------------------	---

To the installer: Please leave this instruction book with the unit.

To the consumer: Please read and keep this book for future reference.

Models SF195LEK, GS440LEL,
GS445LEL, GS458LEL,
GS460LEL, GS465LEL,
GS470LEL, GS475LEL

TABLE OF CONTENTS

RANGE SAFETY	2	Meat Thermometer.....	10
The Anti-Tip Bracket	3	Oven Vent	11
PARTS AND FEATURES	5	Baking and Roasting	11
COOKTOP USE	6	CHOICE BAKE™ Function.....	11
Cooktop Controls.....	6	Broiling.....	11
Surface Burners	6	Warm Hold Feature	12
Home Canning	7	Timed Cooking	12
Cookware	7	Sequence Programming	13
ELECTRONIC OVEN CONTROL	8	Warming Drawer.....	14
Display	8	RANGE CARE	15
Start	8	Self-Cleaning Cycle.....	15
Cancel	8	General Cleaning	16
Clock	8	Oven Light	16
Tones.....	8	Oven Door	17
Fahrenheit and Celsius.....	8	Storage Drawer	17
Timer.....	9	Warming Drawer.....	17
Control Lock.....	9	TROUBLESHOOTING	18
12-Hour Shutoff.....	9	ASSISTANCE OR SERVICE	19
Oven Temperature Control	9	WARRANTY	20
OVEN USE	9		
Aluminum Foil.....	9		
Positioning Racks and Bakeware	9		
Split Oven Rack.....	10		
Bakeware.....	10		



RANGE SAFETY

Your safety and the safety of others are very important.

We have provided many important safety messages in this manual and on your appliance. Always read and obey all safety messages.



This is the safety alert symbol.

This symbol alerts you to potential hazards that can kill or hurt you and others.

All safety messages will follow the safety alert symbol and either the word “DANGER” or “WARNING.” These words mean:

! DANGER

You can be killed or seriously injured if you don't immediately follow instructions.

! WARNING

You can be killed or seriously injured if you don't follow instructions.

All safety messages will tell you what the potential hazard is, tell you how to reduce the chance of injury, and tell you what can happen if the instructions are not followed.

WARNING: If the information in this manual is not followed exactly, a fire or explosion may result causing property damage, personal injury or death.

- Do not store or use gasoline or other flammable vapors and liquids in the vicinity of this or any other appliance.
- **WHAT TO DO IF YOU SMELL GAS:**
 - Do not try to light any appliance.
 - Do not touch any electrical switch.
 - Do not use any phone in your building.
 - Immediately call your gas supplier from a neighbor's phone. Follow the gas supplier's instructions.
 - If you cannot reach your gas supplier, call the fire department.
- Installation and service must be performed by a qualified installer, service agency or the gas supplier.

The Anti-Tip Bracket

The range will not tip during normal use. However, the range can tip if you apply too much force or weight to the open door without the anti-tip bracket fastened down properly.



! WARNING

Tip Over Hazard

- A child or adult can tip the range and be killed.**
- Connect anti-tip bracket to rear range foot.**
- Reconnect the anti-tip bracket, if the range is moved.**
- See the installation instructions for details.**
- Failure to follow these instructions can result in death or serious burns to children and adults.**

Anti-Tip Bracket

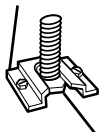

Range Foot

Making sure the anti-tip bracket is installed:

- Slide range forward.
- Look for the anti-tip bracket securely attached to floor.
- Slide range back so rear range foot is under anti-tip bracket.

The California Safe Drinking Water and Toxic Enforcement Act requires the Governor of California to publish a list of substances known to the State of California to cause cancer, birth defects, or other reproductive harm, and requires businesses to warn of potential exposure to such substances.

WARNING: This product contains a chemical known to the State of California to cause cancer, birth defects, or other reproductive harm.

This appliance can cause low-level exposure to some of the substances listed, including benzene, formaldehyde, carbon monoxide, toluene, and soot.

IMPORTANT SAFETY INSTRUCTIONS

WARNING: To reduce the risk of fire, electrical shock, injury to persons, or damage when using the range, follow basic precautions, including the following:

- **WARNING:** TO REDUCE THE RISK OF TIPPING OF THE RANGE, THE RANGE MUST BE SECURED BY PROPERLY INSTALLED ANTI-TIP DEVICES. TO CHECK IF THE DEVICES ARE INSTALLED PROPERLY, SLIDE RANGE FORWARD, LOOK FOR ANTI-TIP BRACKET SECURELY ATTACHED TO FLOOR, AND SLIDE RANGE BACK SO REAR RANGE FOOT IS UNDER ANTI-TIP BRACKET.
- **CAUTION:** Do not store items of interest to children in cabinets above a range or on the backguard of a range – children climbing on the range to reach items could be seriously injured.
- Proper Installation – The range, when installed, must be electrically grounded in accordance with local codes or, in the absence of local codes, with the *National Electrical Code, ANSI/NFPA 70*. In Canada, the range must be electrically grounded in accordance with Canadian Electrical Code. Be sure the range is properly installed and grounded by a qualified technician.

- This range is equipped with a three-prong grounding plug for your protection against shock hazard and should be plugged directly into a properly grounded receptacle. Do not cut or remove the grounding prong from this plug.
 - Disconnect the electrical supply before servicing the appliance.
 - Never Use the Range for Warming or Heating the Room.
 - Injuries may result from the misuse of appliance doors or drawers such as stepping, leaning, or sitting on the doors or drawers.
 - Maintenance – Keep range area clear and free from combustible materials, gasoline, and other flammable vapors and liquids.
 - Storage in or on the Range – Flammable materials should not be stored in an oven or near surface units.
 - Top burner flame size should be adjusted so it does not extend beyond the edge of the cooking utensil.
- For self-cleaning ranges –**
- Before Self-Cleaning the Oven – Remove broiler pan and other utensils. Wipe off all excessive spillage before initiating the cleaning cycle.

SAVE THESE INSTRUCTIONS

PARTS AND FEATURES

This manual covers several different models. The range you have purchased may have some or all of the parts and features listed. The locations and appearances of the features shown here may not match those of your model.

Control Panel

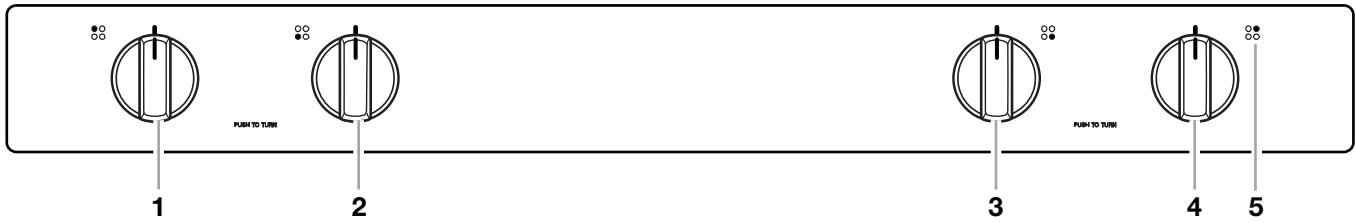

- 1. Left Rear Burner Control
- 2. Left Front Burner Control
- 3. Right Front Burner Control
- 4. Right Rear Burner Control
- 5. Surface Burner Locator

Range

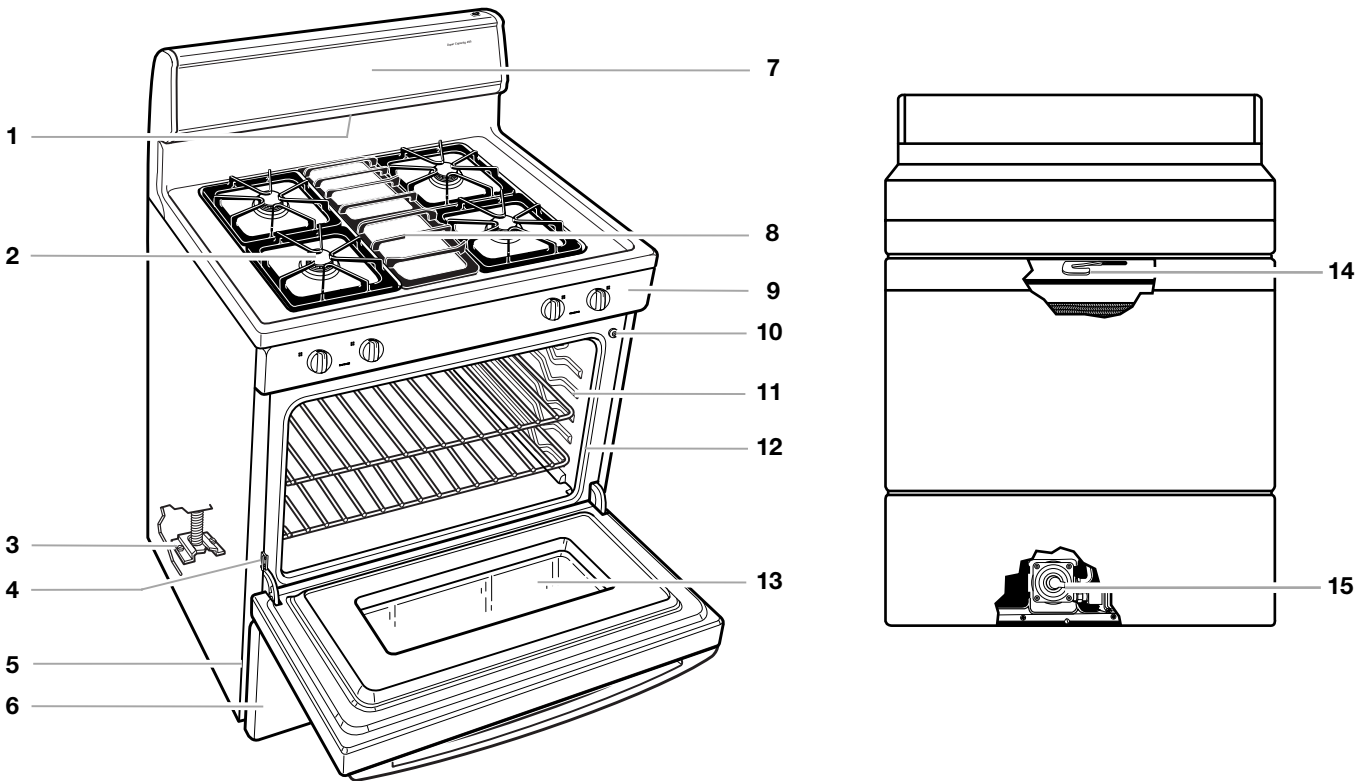

- | | | |
|--|--|---|
| <ul style="list-style-type: none"> 1. Oven Vent 2. Surface Cooking Area 3. Anti-Tip Bracket 4. Oven Door Hinge | <ul style="list-style-type: none"> 5. Model and Serial Number Plate
(behind left side of storage drawer) 6. Storage Drawer 7. Control Panel 8. Center Grate 9. Surface Burner Control | <ul style="list-style-type: none"> 10. Automatic Oven Light Switch 11. Oven Rack 12. Gasket 13. Oven Door Window 14. Self-Clean Latch 15. Gas Regulator |
|--|--|---|

Parts and Features Not Shown
 Oven Door Window
 Oven Light
 Broiler Pan and Grid
 Roasting Rack

COOKTOP USE

Cooktop Controls

! WARNING



Fire Hazard

Do not let the burner flame extend beyond the edge of the pan.

Turn off all controls when not cooking.

Failure to follow these instructions can result in death or fire.

Electric igniters automatically light the surface burners when control knobs are turned to LIGHT.

Before setting a control knob, place filled cookware on the grate. Do not operate a burner using empty cookware or while the grate is unoccupied.

To Set:

1. Push in and turn knob counterclockwise to LIGHT. All four surface burners will click. Only the burner with the control knob turned to LIGHT will produce a flame.
2. Turn knob anywhere between HIGH and LOW. Use the following chart as a guide when setting heat levels.

SETTING	RECOMMENDED USE
LIGHT	<ul style="list-style-type: none"> Light the burner.
HIGH	<ul style="list-style-type: none"> Start food cooking. Bring liquid to a boil.
BETWEEN HIGH and LOW	<ul style="list-style-type: none"> Hold a rapid boil. Quickly brown or sear food. Fry or sauté foods. Cook soups, sauces and gravies. Stew or steam foods.
LOW	<ul style="list-style-type: none"> Keep food warm. Melt chocolate or butter. Simmer.

REMEMBER: When range is in use or (on some models) during the Self-Cleaning cycle, the entire cooktop area may become hot.

Power failure

In case of prolonged power failure, the surface burners can be lit manually. Hold a lit match near a burner and turn knob counterclockwise to LIGHT. After burner lights, turn knob to setting.

Surface Burners

IMPORTANT: Do not obstruct the flow of combustion and ventilation air around the burner grate edges.

Before cleaning, make sure all controls are off and the oven and cooktop are cool. Do not use oven cleaners, bleach or rust removers.

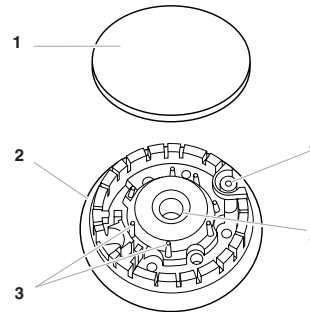

1. Burner Cap
2. Burner Base
3. Alignment Pins
4. Igniter
5. Gas Tube Opening

Burner Cap: Always keep the burner cap in place when using a surface burner. A clean burner cap will help prevent poor ignition and uneven flames. Always clean the burner cap after a spillover and routinely remove and clean the caps according to the "General Cleaning" section.

Gas Tube Opening: Gas must flow freely throughout the gas tube opening for the burner to light properly. Keep this area free of soil and do not allow spills, food, cleaning agents or any other material to enter the gas tube opening. Protect it from spillovers by always using a burner cap.

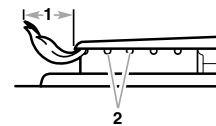

1. 1-1/2 in. (25-38 mm)
2. Burner Ports

Burner Ports: Check burner flames occasionally for proper size and shape as shown above. A good flame is blue in color, not yellow. Keep this area free of soil and do not allow spills, food, cleaning agents or any other material to enter the burner ports.

To Clean:

1. Remove the burner cap from the burner base and clean according to “General Cleaning” section.
2. Clean the gas tube opening with a damp cloth.
3. Clean clogged burner ports with a straight pin as shown. Do not enlarge or distort the port. Do not use a wooden toothpick. If the burner needs to be adjusted, contact a trained repair specialist.

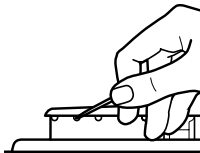

4. Replace the burner cap, making sure the alignment pins on the cap are properly aligned with the burner base.



1. Incorrect
2. Correct

5. Turn on the burner. If the burner does not light, check cap alignment. If the burner still does not light, do not service the sealed burner yourself. Contact a trained repair specialist.

Home Canning

When canning for long periods, alternate the use of surface cooking areas, elements or surface burners between batches. This allows time for the most recently used areas to cool.

- Center the canner on the grate or largest surface cooking area or element. Canners should not extend more than 1 in. (2.5 cm) outside the cooking area.
- Do not place canner on two surface cooking areas, elements or surface burners at the same time.
- On ceramic glass models, only use flat-bottomed canners.
- On coil element models, the installation of a Canning Unit Kit is recommended. If a kit is not installed, the life of the coil element will be shortened. See “Assistance or Service” for ordering instructions.
- For more information, contact your local U.S. Government Agricultural Department Extension Office. In Canada, contact Agriculture Canada. Companies that manufacture home canning products can also offer assistance.

Cookware

IMPORTANT: Never leave empty cookware on a hot surface cooking area, element or surface burner.

Ideal cookware should have a flat bottom, straight sides, a well-fitting lid and the material should be of medium-to-heavy thickness.

Rough finishes may scratch the cooktop. Aluminum and copper may be used as a core or base in cookware. However, when used as a base it can leave permanent marks on the cooktop or grates.

Cookware material is a factor in how quickly and evenly heat is transferred, which affects cooking results. A nonstick finish has the same characteristics as its base material. For example, aluminum cookware with a nonstick finish will take on the properties of aluminum.

Use the following chart as a guide for cookware material characteristics.

COOKWARE	CHARACTERISTICS
Aluminum	<ul style="list-style-type: none"> ■ Heats quickly and evenly. ■ Suitable for all types of cooking. ■ Medium or heavy thickness is best for most cooking tasks.
Cast iron	<ul style="list-style-type: none"> ■ Heats slowly and evenly. ■ Good for browning and frying. ■ Maintains heat for slow cooking.
Ceramic or Ceramic glass	<ul style="list-style-type: none"> ■ Follow manufacturer's instructions. ■ Heats slowly, but unevenly. ■ Ideal results on low to medium heat settings.
Copper	<ul style="list-style-type: none"> ■ Heats very quickly and evenly.
Earthenware	<ul style="list-style-type: none"> ■ Follow manufacturer's instructions. ■ Use on low heat settings.
Porcelain enamel-on-steel or cast iron	<ul style="list-style-type: none"> ■ See stainless steel or cast iron.
Stainless steel	<ul style="list-style-type: none"> ■ Heats quickly, but unevenly. ■ A core or base of aluminum or copper on stainless steel provides even heating.

ELECTRONIC OVEN CONTROL

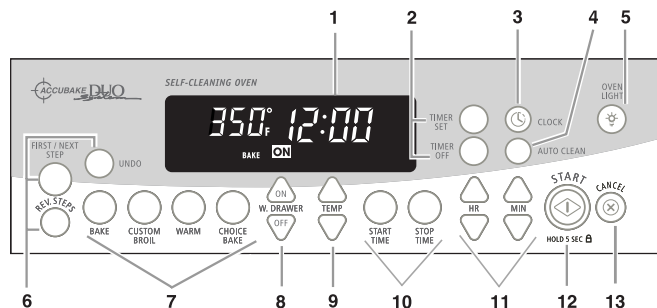

- | | | | |
|---------------|--|------------------------------------|------------------------|
| 1. Display | 5. Oven Light Pad | 8. Warming Drawer (on some models) | 11. Hour/Minute |
| 2. Timer | 6. Sequence Programming (on some models) | 9. Temperature | 12. Start/Control Lock |
| 3. Clock | 7. Oven Settings | 10. Timed Cooking | 13. Cancel |
| 4. Auto Clean | | | |

Display

When power is first supplied to the appliance, "PF" and the current time will appear on the display. Press any pad to clear "PF" from the display.

Any other time "PF" appears, a power failure has occurred. Press any pad and reset the Clock if needed.

When the oven is not in use, the display shows the time of day.

When performing a timed cook function, the display will show either hours and minutes, or minutes and seconds.

Start

The START pad begins any oven function. If not pressed within 5 seconds after pressing a function pad, the "START?" indicator light will flash as a reminder. On some models, "START?" will appear on the display.

If not pressed within 5 minutes after pressing a function pad, the oven display will return to the time of day mode and the programmed function will be canceled.

Cancel

The CANCEL pad stops any function except the Clock, Timer and Control Lock.

Clock

This is a 12-hour clock and does show a.m. or p.m.

To Set:

Before setting, make sure the oven and Timer are off.

1. Press CLOCK.
2. Press the HR or MIN "up" or "down" arrow pads to set the time of day, including a.m. or p.m.
3. Press CLOCK or START.

Tones

Tones are audible signals, indicating the following:

One tone

- Valid pad press
- Oven is preheated (long tone)
- Function has been entered

Three tones

- Invalid pad press

Four tones

- End of cycle
- Reminder, repeating each minute after the end-of-cycle tones

Reminder Tones

Reminder tones may be turned off. Press and hold STOP TIME for 5 seconds. "rEP OFF" will appear in the display. Repeat to turn reminder tones back on, and "rEP on" will appear in the display.

All Tones

All of the above tones are preset on, all except the end-of-cycle tones can be turned off.

To Turn Off/On: Press and hold START TIME for 5 seconds. A tone will sound and "Snd OFF" will appear on the display. Repeat to turn tones on and "Snd on" will appear on the display.

Fahrenheit and Celsius

The temperature is preset at Fahrenheit, but can be changed to Celsius.

To Change: Press and hold BROIL for 5 seconds. A tone will sound and "°C" will appear on the display. Repeat to change back to Fahrenheit. To exit mode, press CANCEL.

Timer

The Timer can be set in hours or minutes up to 12 hours and 59 minutes, and counts down the set time. The Timer does not start or stop the oven.

To Set:

1. Press TIMER SET.
If no action is taken after 5 minutes, the display will return to the time of day mode.
2. Press the HR or MIN “up” or “down” arrow pads to set the length of time to cook.
3. Press START or TIMER SET.
When the set time ends, end-of-cycle tones will sound, then, if enabled, reminder tones will sound every minute.
4. Press TIMER OFF anytime to cancel the Timer.
Remember, do not press the CANCEL pad because the oven will turn off.

To display the time of day for 5 seconds when the timer is counting down, press CLOCK.

Control Lock

The Control Lock shuts down the control panel pads to prevent unintended use of the oven.

When the control is locked, only the ACCUSIMMER®, CLOCK, OVEN LIGHT and TIMER pads will function.

To Lock/Unlock Control: Before locking, make sure the oven and Timer are off. Press and hold START for 5 seconds. A single tone will sound and “Loc” will appear on the display.

Repeat to unlock. “Loc” will disappear from the display.

12-Hour Shutoff

The oven control is set to automatically shut the oven off 12 hours after the oven turns on. This will not interfere with any timed or delayed cook function.

The oven light will come on when the oven door is opened. To keep the light on continuously, turn the light on by pressing OVEN LIGHT.

To Override:

For longer cooking periods that require oven usage longer than 12 hours, press and hold CLOCK for 5 seconds. A single tone will sound and “12H OFF” will appear on the display. The oven will remain on until turned off.

To Reset:

Press and hold CLOCK for 5 seconds. A single tone will sound and “12H on” will appear on the display.

Oven Temperature Control

IMPORTANT: Do not use a thermometer to measure oven temperature because opening the oven door and element or burner cycling may give incorrect readings.

The oven provides accurate temperatures; however, it may cook faster or slower than your previous oven, so the temperature calibration can be adjusted. It can be changed in Fahrenheit or Celsius.

A minus sign means the oven will be cooler by the displayed amount. No sign means the oven will be warmer by the displayed amount. Use the following chart as a guide.

ADJUSTMENT °F (°C)	COOKS FOOD
10°F (5°C)	...a little more
20°F (10°C)	...moderately more
30°F (15°C)	...much more
-10°F (-5°C)	...a little less
-20°F (-10°C)	...moderately less
-30°F (-15°C)	...much less

To Adjust Oven Temperature Calibration:

1. Press and hold BAKE for 5 seconds until the oven display shows the current calibration, for example “0°F CAL.”
 2. Press the TEMP “up” or “down” arrow pad(s) to increase or to decrease the temperature in 10°F (5°C) amounts. The adjustment can be set between 30°F (15°C) and -30°F (-15°C).
 3. Press START.
-

OVEN USE

Odors and smoke are normal when the oven is used the first few times, or when it is heavily soiled.

IMPORTANT: The health of some birds is extremely sensitive to the fumes given off. Exposure to the fumes may result in death to certain birds. Always move birds to another closed and well ventilated room.

Aluminum Foil

IMPORTANT: Do not line the oven bottom with any type of foil, liners or cookware because permanent damage will occur to the oven bottom finish.

- Do not block or cover the oven bottom vents.
 - Do not cover entire rack with foil because air must be able to move freely for best cooking results.
 - To catch spills, place foil on rack below dish. Make sure foil is at least 1 in. (2.5 cm) larger than the dish and that it is turned up at the edges.
-

Positioning Racks and Bakeware

IMPORTANT: Never place food or bakeware directly on the oven door or bottom. Permanent damage will occur to the porcelain finish.

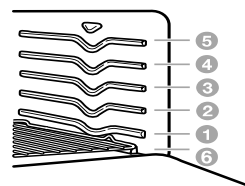

RACKS

Position racks before turning the oven on. Do not move racks with bakeware on them. Make sure racks are level. To move a rack, pull it out to the stop position, raise the front edge, then lift out. Use the following illustration and chart as a guide.

FOOD	RACK POSITION
Frozen pies, large roasts, turkeys, angel food cakes	1 or 2
Bundt cakes, most quick breads, yeast breads, casseroles, meats	2
Cookies, biscuits, muffins, cakes, non-frozen pies	2 or 3
Extra large items	6

BAKEWARE

To cook food evenly, hot air must be able to circulate. Allow 2 in. (5 cm) of space around bakeware and oven walls. Use the following chart as a guide.

NUMBER OF PAN(S)	POSITION ON RACK
1	Center of rack.
2	Side by side or slightly staggered.
3 or 4	Opposite corners on each rack. Make sure that no bakeware piece is directly over another.

Split Oven Rack (on some models)

Split Oven Rack with Removable Insert

The split oven rack with removable insert is a space maximizer. When the two are attached, they make a full rack. The insert can also be removed to provide room for large items such as a turkey and casseroles, and it can also be used on the counter for a cooling rack.

Do not place more than 25 lbs. (11.3 kg) on the split oven rack or on the removable insert piece.

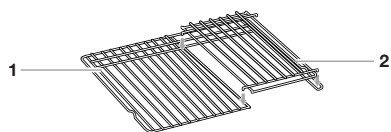

1. Split-Rack
2. Removable Insert

To Use Racks:

- Place a full rack on position 1 or 2, and the split oven rack on position 3 or 4.
- Place large items on the right side of the full rack.
- Place deeper, covered dishes on the left side of the full rack.
- Place shallow dishes on the split oven rack.

- After the cooking is finished, carefully remove items.

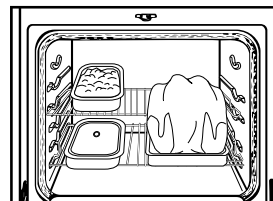

Bakeware

The bakeware material affects cooking results. Follow manufacturer's recommendations and use the bakeware size recommended in the recipe. Use the following chart as a guide.

BAKEWARE/ RESULTS	RECOMMENDATIONS
Light colored aluminum <ul style="list-style-type: none"> Light golden crusts Even browning 	<ul style="list-style-type: none"> Use temperature and time recommended in recipe.
Dark aluminum and other bakeware with dark, dull and/ or nonstick finish <ul style="list-style-type: none"> Brown, crisp crusts 	<ul style="list-style-type: none"> May need to reduce baking temperatures 25°F (15°C). Use suggested baking time. For pies, breads and casseroles, use temperature recommended in recipe. Place rack in center of oven.
Insulated cookie sheets or baking pans <ul style="list-style-type: none"> Little or no bottom browning 	<ul style="list-style-type: none"> Place in the bottom third of oven. May need to increase baking time.
Stainless steel <ul style="list-style-type: none"> Light, golden crusts Uneven browning 	<ul style="list-style-type: none"> May need to increase baking time.
Stoneware <ul style="list-style-type: none"> Crisp crusts 	<ul style="list-style-type: none"> Follow manufacturer's instructions.
Ovenproof glassware, ceramic glass or ceramic <ul style="list-style-type: none"> Brown, crisp crusts 	<ul style="list-style-type: none"> May need to reduce baking temperatures 25°F (15°C).

Meat Thermometer

On models without a temperature probe, always rely on a meat thermometer to determine doneness of meat and poultry. The internal temperature, not appearance, is what counts. A meat thermometer is not supplied with this appliance.

- Insert the thermometer into the center of the thickest portion of the meat or inner thigh or breast of poultry. The tip of the thermometer should not touch fat, bone or gristle.
- After reading the thermometer once, push it into the meat ½ in. (1.25 cm) more and read again. If the temperature drops, cook the meat or poultry longer.
- Check all meat in two or three places.

Oven Vent

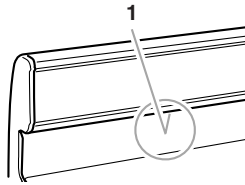

1. Oven Vent

The oven vent releases hot air and moisture from the oven, and should not be blocked or covered. Doing so will cause poor air circulation, affecting cooking and cleaning results. Never set plastics, paper or other items that could melt or burn near the oven vent.

Baking and Roasting

ACCUBAKE® DUO SYSTEM™ Technology Temperature Management

The ACCUBAKE® DUO SYSTEM™ technology electronically regulates the oven heat levels during preheat and bake to maintain the most uniform temperature control.

Two temperature sensors will independently control the bake and broil elements for optimal cooking results. The bake and broil elements cycle on and off in intervals. The bake element will glow red when cycling on, but the broil element will not. This feature is automatically activated when the oven is in use.

Before baking and roasting, position racks according to the "Positioning Racks and Bakeware" section. When roasting, it is not necessary to wait for the oven preheat conditioning time to end before putting food in unless recommended in the recipe.

To Bake or Roast:

1. Press **BAKE**.
Press TEMP "up" or "down" arrow pad to set a temperature other than 350°F (175°C) in 5° amounts. The bake range can be set between 170°F and 500°F (75°C and 260°C).
2. Press **START**.
The temperature can be changed after this step. **START** does not need to be pressed again.
3. Press **CANCEL** when finished.

Preheating

After **START** is pressed, the oven will enter a timed preheat conditioning. "PrE" and the countdown time will appear on the display. When the preheat conditioning time ends, a tone will sound and the selected temperature will appear on the display.

Preheat temperatures are affected by varying factors such as room temperature and peak energy usage times. It is normal for the temperature showing on the display and the actual oven temperature to differ due to the cycling of the elements.

CHOICE BAKE™ Function

The CHOICE BAKE™ function minimizes the top heat during oven cooking. It is ideal for baking pies, casseroles and breads, and for roasting foods that require longer and slower cook times such as poultry and roasts.

Similar to the baking and roasting function, the bake elements or burners cycle on and off at intervals during CHOICE BAKE™ cycle. However, the cycle duration for the broil element is much shorter during CHOICE BAKE™ cycle, allowing less top browning of foods and more customized control for your baking results.

To Use:

1. Press CHOICE BAKE™ function.
Press the TEMP "up" or "down" arrow pad to set a temperature other than 350°F (175°C) in 5° amounts. The bake range can be set between 170°F and 500°F (75°C and 260°C).
2. Press **START**.
The temperature can be changed after this step. **START** does not need to be pressed again.
3. Press **CANCEL** when finished cooking.
To use the CHOICE BAKE™ function during a regular BAKE cycle to achieve less top browning, press CHOICE BAKE™ button, set the desired temperature and press **START**.

Broiling

Broiling uses direct radiant heat to cook food. Changing the temperature when Custom Broiling allows more precise control when cooking. The lower the temperature, the slower the cooking. Thicker cuts and unevenly shaped pieces of meat, fish and poultry may cook better at lower broiling temperatures.

- Use only the broiler pan and grid provided with the range. It is designed to drain juices and help prevent spatter and smoke.
- For proper draining, do not cover the grid with foil. The bottom of the pan may be lined with aluminum foil for easier cleaning.
- Trim excess fat to reduce spattering. Slit the remaining fat on the edges to prevent curling.
- Pull out oven rack to stop position before turning or removing food. Use tongs to turn food to avoid the loss of juices. Very thin cuts of fish, poultry or meat may not need to be turned.
- After broiling, remove the pan from the oven when removing the food. Drippings will bake on the pan if left in the heated oven, making cleaning more difficult.

Before broiling, position rack according to Broiling chart. It is not necessary to preheat the oven before putting food in unless recommended in the recipe. Position food on grid in the broiler pan, then place it in the center of the oven rack. Close the door.

To Broil:

1. Press **CUSTOM BROIL**.
2. Press **START/ENTER**.
3. Press **CANCEL** when finished.

To Custom Broil:

1. Press CUSTOM BROIL.
2. Press TEMP “up” or “down” arrow pad to change the temperature in 5° amounts. The broil range can be set between 300°F (150°C) and HI (525°F [275°C]).
3. Press START/ENTER.
4. Press CANCEL when finished.

BROILING CHART

For best results, place food 3 in. (7 cm) or more from the broil burner. Times are guidelines only and may need to be adjusted for individual tastes. Recommended rack positions are numbered from the bottom (1) to the top (5). For diagram, see the “Positioning Racks and Bakeware” section.

FOOD	RACK POSITION	Approximate Time (minutes)	
		SIDE 1	SIDE 2
Steak 1 in. (2.5 cm) thick medium rare medium well done	4 4 4	14-15 15-16 18-19	7-8 8-9 9-10
*Ground meat patties ¾ in. (2 cm) thick well done	4	13-14	6-7
Pork chops 1 in. (2.5 cm) thick	4	21-22	10-11
Ham slice, precooked ½ in. (1.25 cm) thick	4	8-10	4-5
Frankfurters	4	6-7	3-4
Lamb chops 1 in. (2.5 cm) thick	4	15-17	8-9
Chicken bone-in pieces boneless breasts	3 4	18-20 12-16	18-20 11-16
Fish Fillet ¼- ½ in. (.6-1.25 cm) thick Steaks ¾- 1 in. (2-2.5 cm) thick	4 4	8-10 15-18	4-5 7-9

* Place up to 9 patties, equally spaced, on broiler grid.

Warm Hold Feature

⚠ WARNING

Food Poisoning Hazard

Do not let food sit in oven more than one hour before or after cooking.

Doing so can result in food poisoning or sickness.

IMPORTANT: Food must be at serving temperature before placing it in the warmed oven. Food may be held up to 1 hour, however breads and casseroles may become too dry if left in the oven during Warm Hold.

Warm Hold Feature allows hot cooked foods to stay serving temperature. It can also be used at the end of a timed cook.

To Use Automatic Warm Hold Feature:

At the end of a timed cook, either with or without a delayed start, or at the end of a sequence program in which the last step is not the Warm Hold mode, the oven will automatically default to a 1-hour Warm Hold mode at 170°F (77°C).

When using the Automatic Warm Hold Feature, cook times may need to be adjusted accordingly so that foods do not become over cooked and dry.

When the cook time ends or the last step of the sequence is complete, the display will show a warming countdown time. When warming ends, the oven will automatically shut off and “End” will appear on the display. Four tones will sound and then four 1-second reminder tones will sound every minute thereafter.

To Disable Automatic Warm Hold: Press and hold WARM for 5 seconds. “Off” will appear in the 4-digit display. Repeat to turn back on.

To Use Manual Warm Hold Feature:

1. Press WARM.
2. Set the temperature (optional).
Press the TEMP “up” or “down” arrow pad to raise or lower the temperature in 5°F (3°C) amounts to set a temperature other than 150°F (66°C). The warm range is 100°F-200°F (38°C-93°C).
3. Press START.
4. Press CANCEL when finished.

Timed Cooking

⚠ WARNING

Food Poisoning Hazard

Do not let food sit in oven more than one hour before or after cooking.

Doing so can result in food poisoning or sickness.

Timed Cooking allows the oven to be set to turn on at a certain time of day, cook for a set length of time, and/or shut off automatically. Delay start should not be used for foods such as breads and cakes which use ingredients such as yeast or baking powder to leaven the food.

To Set a Timed Cook:

1. Press BAKE (optional).
Press the TEMP “up” or “down” arrow pads to enter a temperature other than the one displayed.
2. Press STOP TIME.
3. Press the HR and MIN “up” or “down” arrow pads to enter the desired time to end cooking.
4. Press START.
The display will count down the time.
When the time ends, the oven will shut off automatically and “End” will appear on the display.
End-of-cycle tones will sound; then, if enabled, reminder tones will sound every minute.
5. Open and close the oven door to clear the display and/or stop reminder tones.

To Set a Delayed Timed Cook:

Before setting, make sure the clock is set to the correct time of day. See "Clock" section.

1. Press desired cook function.
Press the TEMP "up" or "down" arrow pads to enter a temperature other than the one displayed.
2. Press START TIME.
3. Press the HR and MIN "up" or "down" arrow pads to enter the time of day to start.
4. Press STOP TIME (optional).
5. If STOP TIME has been pressed, press the HR and MIN "up" or "down" arrow pads to enter the desired time to end cooking.
6. Press START.
"DELAY" will appear on the display.

When the start time is reached, the oven will automatically turn on.

When the stop time is reached (if programmed), the oven will shut off automatically and "End" will appear on the display.

End-of-cycle tones will sound; then, if on, reminder tones will sound every minute.

7. Open and close the oven door to clear the display and/or stop reminder tones.

Sequence Programming

(on some models)

Sequence Programming allows you to program at one time up to four cook functions, and is usable with other electronic oven control functions, such as the Timer and Warming Drawer.

Sequence Programming takes precedence over any non-sequenced cook function. For example, if an untimed Bake function is in process and a sequence program is started, the untimed Bake function will be canceled, and the program sequence will start.

All steps of a sequenced program must be programmed with a stop time. If a stop time is not entered for a step in the sequence program, and the FIRST/NEXT STEP pad is pressed, three tones will sound.

To Program the First Step of the Sequence:

1. Press FIRST/NEXT STEP.
"PROGRAM" and "STEP" will appear on the display. A flashing "1" will also appear on the display, indicating that step 1 is being programmed.
2. Choose the desired cook function by pressing any cook function key.
3. Press START TIME, then HR and MIN "up" or "down" arrow pads to set the time of day for the first cook function to begin. If START TIME is not pressed, then the sequence of cook functions will begin immediately once programming is complete and START is pressed.
The display will show either the time of day (if start time was not programmed) or the start time (if same was programmed), but with a flashing colon. "Stop" and "Time" will also appear on the display.
4. Press STOP TIME, then HR and MIN "up" or "down" arrow pads to set the time of day for the first cook function to stop.

To Program Next Steps of the Sequence:

1. Press FIRST/NEXT STEP.
"PROGRAM" and "STEP" will appear on the display. The number of the steps being programmed will flash.
"START" and "TIME" will appear on the display.
2. Choose the desired cook function by pressing any cook function key.
Press TEMP "up" or "down" arrow pad (if desired) to select temperature.
3. Press STOP TIME, then HR and MIN "up" or "down" arrow pads to select stop time.
4. Press START to begin sequence.
5. Press CANCEL at any time to clear program and to stop program.

To Review/Modify Programmed Sequence:

If program steps are partially or completely programmed, yet the sequence has not been started, the programmed cook functions can be reviewed.

1. Press REVIEW STEPS. Step 1 will appear in the display. Subsequent presses of REVIEW STEPS will cause display of programmed steps in order.
"STEP" and "RECALL" will appear on the display. The number of the displayed step will flash. A recalled step will remain lit on the display for 5 minutes if no further action is taken.
2. If fewer than four steps have been programmed, press REVIEW STEPS repeatedly until the last programmed step is displayed, then press FIRST/NEXT STEP if it is desired to program an additional step.
While a step is recalled, a cook function pad can be used to change the function, or the TEMPERATURE "up" or "down" arrow pad can be used to change the set temperature.
START TIME, when used with the HR or MIN "up" or "down" arrow pads, can be used to change, add or delete a delayed start.
STOP TIME can be used to change the stop time. Changing the stop time of a step will automatically change the start times and stop times of all subsequent programmed cook functions.
3. After Review/Modification of the programmed sequence is complete, press START to begin sequence.

To Modify Sequence Programming:

1. Press UNDO.
The last step of the sequence will be canceled, and the step prior to the canceled sequence will show on the display for either review or modification.
If the programmed sequence has not been started, see "To Program Next Steps of the Sequence" section to program a step to replace the canceled cook function.
2. Press START.
The first step will show on the display and the program sequence will begin.
Changes can be made during a programmed cook function; however, changes cannot be made after a programmed cook function has been completed.
If at any time during an active sequenced program FIRST/NEXT STEP is pressed, three tones will sound.

Warming Drawer

(on some models)

WARNING

Food Poisoning Hazard

Do not let food sit for more than one hour before or after cooking.

Doing so can result in food poisoning or sickness.

The Warming Drawer is ideal for keeping hot cooked foods at serving temperature. It may also be used for warming breads and pastries.

Different types of food may be placed in the warming drawer at the same time. For best results, do not hold foods longer than one hour. For smaller quantities or heat-sensitive foods, such as eggs, do not hold longer than 30 minutes.

Food must be at serving temperature before being placed in the warming drawer. Breads, pastries, and fruit pies may be heated from room temperature on the HI setting.

Remove food from plastic bags and place in oven-safe container. Cover foods with a lid or aluminum foil.

Do not cover with plastic wrap.

Empty serving dishes and oven proof dishes can be heated while the warming drawer is preheating.

Do not place food to be warmed directly on the warming drawer surface.

To Use:

1. Place cooked food(s) in warming drawer.
2. Press WARMING DRAWER. “dr Lo,” “DRAWER” and “START?” will appear on the display.
3. Press START. “DRAWER” and “ON” will appear on the display.
4. Press DRAWER OFF when finished.

Warming Drawer Settings:

The warming drawer is pre-set for a “Lo” temperature, but can be changed by pressing the TEMP “up” arrow pad. Use the following chart as a guide when selecting a different temperature other than “Lo.”

SETTINGS	TEMPERATURES
dr Lo (Low) keeps soft rolls warm	100°F (38°C)
dr 2 (Medium Low)	140°F (60°C)
dr 3 (Medium)	160°F (71°C)
dr 4 (Medium High)	180°F (88°C)
dr HI (High) keeps french fries crisp and warm	195°F (91°C)

Warming Drawer Temperature Chart

Different foods require different settings in order to maintain the ideal serving temperature. Use the following chart as a guide.

FOOD	SETTING
Appetizers	dr HI
Biscuits	dr LO
Chicken Boneless, Breaded Nuggets	dr HI dr HI
Coffee Cake	dr LO
Dinner Plate (1) Salisbury Steak, Mashed Potatoes, Corn	dr HI
Fish Pieces Breaded Battered	dr HI dr HI
French Fries	dr HI
Gravy	dr 4
Ham, Boneless	dr 3
Hard Rolls	dr LO
Lasagna	dr 4
Pastries Pre-Packaged, baked Pre-Packaged, frozen	dr 4 dr LO
Pie Single Crust Double Crust	dr LO dr LO
Pizza	dr 4
Potatoes, Baked	dr 4
Quiche	dr 3
Roast, Boneless	dr 4
Roasted Chicken	dr 4
Soft Rolls	dr LO

RANGE CARE

Self-Cleaning Cycle (on some models)

⚠ WARNING

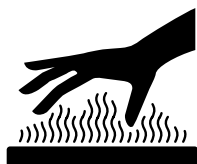

Burn Hazard

Do not touch the oven during the Self-Cleaning cycle.

Keep children away from oven during Self-Cleaning cycle.

Failure to follow these instructions can result in burns.

IMPORTANT: The health of some birds is extremely sensitive to the fumes given off during the Self-Cleaning cycle. Exposure to the fumes may result in death to certain birds. Always move birds to another closed and well ventilated room.

Self-clean the oven before it becomes heavily soiled. Heavy soil results in longer cleaning and more smoke.

Keep the kitchen well-ventilated during the Self-Cleaning cycle to help get rid of heat, odors, and smoke.

Do not block the oven vent during the Self-Cleaning cycle. Air must be able to move freely. See "Oven Vent" section.

Do not clean, rub, damage or move the oven door gasket. The door gasket is essential for a good seal.

Prepare Oven:

- Remove the broiler pan, grid, cookware and bakeware and, on some models, the temperature probe from the oven.
- Remove any foil from the oven because it may burn or melt, damaging the oven.
- Remove oven racks to keep them shiny and easy to slide. See "General Cleaning" section for more information.
- Hand clean inside door edge and the 1½ in. (3.8 cm) area around the inside oven cavity frame, being careful not to move or bend the gasket. This area does not get hot enough during self-cleaning to remove soil. Do not let water, cleaner, etc. enter slots on door frame. Use a damp cloth to clean this area.
- Wipe out any loose soil to reduce smoke and avoid damage. At high temperatures, foods react with porcelain. Staining, etching, pitting or faint white spots can result. This will not affect cooking performance.

Prepare Cooktop and Storage Drawer:

- Remove plastic items from the cooktop because they may melt.
- Remove all items from the storage drawer.

How the Cycle Works

IMPORTANT: The heating and cooling of porcelain on steel in the oven may result in discoloring, loss of gloss, hairline cracks and popping sounds.

The Self-Cleaning cycle uses very high temperatures, burning soil to a powdery ash.

The oven is preset for a 3 hour 30 minute clean cycle, but the time can be changed. Suggested clean times are 2 hours 30 minutes for light soil and between 3 hours 30 minutes to 4 hours 30 minutes for average to heavy soil.

Once the oven has completely cooled, remove ash with a damp cloth. Do not wipe down any of the inside surfaces until the oven has completely cooled down. Applying a cool damp cloth to the inner door glass before it has completely cooled could result in the glass breaking.

The oven light will not work during the Self-Cleaning cycle.

To Self-Clean:

Before self-cleaning, make sure the door is closed completely or it will not lock and the cycle will not begin.

1. Press AUTO CLEAN.
2. Press the HR and MIN "up" or "down" arrow pad to set a clean time other than 3 hours 30 minutes. The clean time can be set between 2 hours 30 minutes and 4 hours 30 minutes.
3. Press START/ENTER.

The oven door will automatically lock. "LOCKED" will appear on the display. The door will not unlock until the oven cools.

When the cycle is complete and the oven cools, "End" will appear on the oven display and "LOCKED" will disappear.

4. Press CANCEL or open the oven door to clear the oven display.

To Delay Start Self-Clean:

Before delay starting Self-Clean, make sure the clock is set to the correct time of day. See "Clock" section. Also, make sure the door is closed completely or it will not lock and the cycle will not begin.

1. Press AUTO CLEAN.
Press the HR "up" or "down" arrow pad to set a clean time other than 3 hours 30 minutes. The clean time can be set between 2 hours 30 minutes and 4 hours 30 minutes.
2. Press START TIME.
3. Press the HR and MIN "up" or "down" arrows pads to enter the time of day to start.
4. Press START/ENTER. The time of day is displayed.

The door will automatically lock and "LOCKED" and "DELAY" will appear on the display. The door will not unlock until the oven cools.

When the start time is reached, the oven will automatically turn on.

When the cycle is complete and the oven cools, "End" will appear on the lower oven display and "LOCKED" will disappear.

5. Press any pad or open the oven door to clear the oven display.

To Stop Self-Clean any time:

Press CANCEL. If the oven temperature is too high, "cln," "TIMED," "ON," "cool," and "LOCKED" will appear on the display and the door will remain locked. It will not unlock until the oven cools.

General Cleaning

IMPORTANT: Before cleaning, make sure all controls are off and the oven and cooktop are cool. Always follow label instructions on cleaning products.

Soap, water and a soft cloth or sponge are suggested first unless otherwise noted.

EXTERIOR PORCELAIN ENAMEL SURFACES (on some models)

Food spills containing acids, such as vinegar and tomato, should be cleaned as soon as the entire appliance is cool. These spills may affect the finish.

- Glass cleaner, mild liquid cleaner or nonabrasive scrubbing pad: Gently clean around the model and serial number plate because scrubbing may remove numbers.

STAINLESS STEEL (on some models)

Do not use soap-filled scouring pads, abrasive cleaners, Cooktop Polishing Creme, steel-wool pads, gritty washcloths or some paper towels. Damage may occur.

Rub in direction of grain to avoid damaging.

- Stainless Steel Cleaner & Polish (not included): See “Assistance or Service” section to order.
- Liquid detergent or all-purpose cleaner: Rinse with clean water and dry with soft, lint-free cloth.
- Vinegar for hard water spots

COOKTOP CONTROLS

Do not use steel wool, abrasive cleansers or oven cleaner.

Do not soak knobs.

When replacing knobs, make sure knobs are in the OFF position.

On some models, do not remove seals under knobs.

- Soap and water or dishwasher: Pull knobs straight away from control panel to remove.

CONTROL PANEL

Do not use abrasive cleaners, steel-wool pads, gritty washcloths or some paper towels. Damage may occur.

- Glass cleaner and soft cloth or sponge: Apply glass cleaner to soft cloth or sponge, not directly on panel.

PORCELAIN-COATED GRATES AND CAPS

Food spills containing acids, such as vinegar and tomato, should be cleaned as soon as the cooktop, grates and caps are cool. These spills may affect the finish.

To avoid chipping, do not bang grates and caps against each other or hard surfaces such as cast iron cookware.

Do not reassemble caps on burners while wet.

Do not clean in the Self-Cleaning cycle.

- Nonabrasive plastic scrubbing pad and mildly abrasive cleanser: Clean as soon as cooktop, grates and caps are cool.
- Dishwasher (grates only, not caps): Use the most aggressive cycle.

SURFACE BURNERS

Sealed Burner models

See “Surface Burners” section.

OVEN DOOR EXTERIOR

- Glass cleaner and paper towels or nonabrasive plastic scrubbing pad: Apply glass cleaner to soft cloth or sponge, not directly on panel.

OVEN CAVITY

Do not use oven cleaners.

Food spills should be cleaned when oven cools. At high temperatures, foods react with porcelain and staining, etching, pitting or faint white spots can result.

- Self-Cleaning cycle: See “Self-Cleaning Cycle” first.

OVEN AND ROASTING RACKS

- Self-Cleaning cycle: See “Self-Cleaning Cycle” first. Remove racks or they will discolor and become harder to slide. If this happens, a light coating of vegetable oil applied to the rack guides will help them slide.
- Steel-wool pad

BROILER PAN AND GRID

Do not clean in the Self-Cleaning cycle.

- Mildly abrasive cleanser: Scrub with wet scouring pad.
- Solution of ½ cup (125 mL) ammonia to 1 gal. (3.75 L) water: Soak for 20 minutes, then scrub with scouring or steel-wool pad.
- Oven cleaner: Follow product label instructions.

Porcelain enamel only, not chrome

- Dishwasher

STORAGE DRAWER (on some models)

Make sure drawer is cool and empty before cleaning.

For more information, see “Storage Drawer” section.

- Mild detergent

Drawer Liner (on some models)

Remove all stored items from drawer and lift out drawer liner.

- Clean with mild detergent.

WARMING DRAWER (on some models)

Make sure drawer is cool.

- Mild detergent

Oven Light

The oven light is a standard 40-watt appliance bulb. It will come on when the oven door is open. It will not work during the Self-Cleaning cycle. On some models, when the oven door is closed, press OVEN LIGHT to turn it on or off.

Before replacing, make sure the oven and cooktop are cool and the control knobs are off.

To replace:

1. Unplug range or disconnect power.
2. Turn the glass bulb cover in the back of the oven counterclockwise to remove.

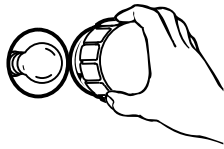

3. Turn bulb counterclockwise to remove from socket.
4. Replace bulb and bulb cover by turning clockwise.
5. Plug in range or reconnect power.

Oven Door

For normal range use, it is not suggested to remove the oven door. However, if necessary, follow these instructions. The oven door is heavy.

Before Removing:

1. Use a putty knife or screwdriver and insert it at the bottom corner of the door stop clip.

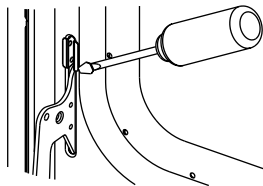

2. Pry door stop clip free and remove from front frame hinge slot. Take care not to scratch finish.
3. Repeat procedure for other door stop clip.

To Remove:

1. Open the oven door. Insert door removal pins, included with your range, into both hinge hangers. Do not remove the pins while the door is removed from the range.

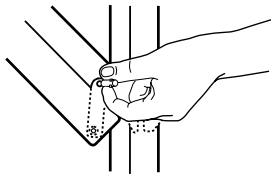

2. Carefully close the door until it rests against the door removal pins.
3. Grasp the door on the sides with your fingers on the front of the door and your thumbs on the inside surface.
4. Pull door straight up, then toward you. Hinge hangers will slide out of front frame hinge slot. Do not remove door removal pins until the door is replaced on the range.

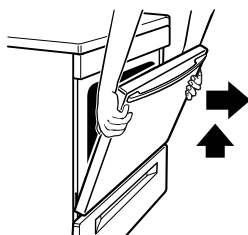
**To Replace:**

1. Grasp the door on the sides with your fingers on the front of the door and your thumbs on the inside surface.
2. Hold oven door so that the top edge of each hinge hanger is horizontal. Insert hinge hangers into the front frame hinge slots.
3. Tilt top of door toward range. Slide hinge hangers down onto front frame support pins. Make sure the hinge hangers are fully seated and engaged on the support pins.

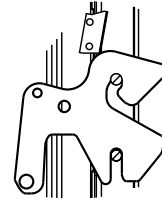

4. Insert the door stop clip with the angular surface at the top of the frame hinge slot, then push in the bottom of the clip until flanges are flush with the front frame.

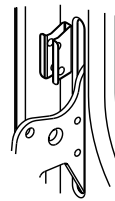

5. Open the door completely and remove the door removal pins. Save door removal pins for future use.
6. Close the door.

Storage Drawer

The storage drawer can be removed. Before removing, make sure drawer is cool and empty.

To Remove:

1. Pull drawer straight out to the first stop.
2. Lift up the back of the drawer and pull out.

To Replace:

1. Fit the ends of the drawer rails into the guides in the cavity.
2. Slide the drawer closed.

Warming Drawer

(on some models)

Remove all items from inside the warming drawer, and allow the unit to cool completely before attempting to remove the drawer.

To Remove:

1. Open drawer to its full open position.
2. Locate the black triangle-shaped tabs on both sides of the drawer.

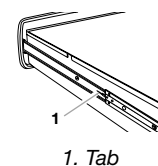

- Press the tab down on the right side, and lift tab up on the left side at the same time, then pull drawer out another inch.

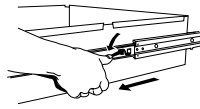

- Holding the drawer by its sides, not its front, carefully pull it all the way out.

To Replace:

- Align the drawer glides with the receiving guides.

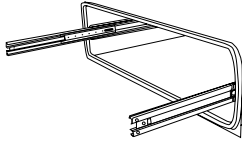

- Push drawer in all the way.
- Gently open and close the drawer to ensure it is seated properly on the slides.

TROUBLESHOOTING

Try the solutions suggested here first in order to avoid the cost of an unnecessary service call.

Nothing will operate

- **Is the power supply cord unplugged?** Plug into a grounded 3 prong outlet.
- **Has a household fuse been blown or has the circuit breaker been tripped?** Replace the fuse or reset the circuit.

Surface burners will not operate

- **Is this the first time the surface burners have been used?** Turn on any one of the surface burner knobs to release air from the gas lines.
- **Is the control knob set correctly?** Push in knob before turning to a setting.
- **Are the burner ports clogged?** See “Surface Burners” section.

Surface burner flames are uneven, yellow and/or noisy

- **Are the burner ports clogged?** See “Surface Burners” section.
- **On models with caps, are the burner caps positioned properly?** See “Surface Burners” section.
- **Is the burner damaged?** On models with caps, look for a warped cap. If cap will not spin freely on a flat surface, painted side down, the cap is warped. Switch cap with a different surface burner to check for further warping. Contact a service technician or see “Assistance or Service” section.
- **Is propane gas being used?** The appliance may have been converted improperly. Contact a service technician or see “Assistance or Service” section.

Surface burner makes popping noises

- **Is the burner wet?** Let it dry.

Excessive heat around cookware on cooktop

- **Is the cookware the proper size?** Use cookware about the same size as the surface cooking area, element or surface burner. Cookware should not extend more than 1 in. (2.5 cm) outside the cooking area.

Cooktop cooking results not what expected

- **Is the proper cookware being used?** See “Cookware” section.
- **Is the control knob set to the proper heat level?** See “Cooktop Controls” section.
- **Is the appliance level?** Level the appliance. See the Installation Instructions.

Oven will not operate

- **Is this the first time the oven has been used?** Turn any one of the surface burner knobs on to release air from the gas lines.
- **Is the electronic oven control set correctly?** See “Electronic Oven Control” section.

Oven burner flames are yellow or noisy

- **Is propane gas being used?** The appliance may have been converted improperly. Contact a service technician or see “Assistance or Service” section.

Cooling fan runs during baking, broiling or cleaning

- It is normal for the fan to automatically run while the oven is in use to cool the electronic control.

Oven temperature too high or too low

- **Does the oven temperature calibration need adjustment?** See “Oven Temperature Control” section.

Display shows messages

- **Is the display showing “PF”?** There has been a power failure. Clear the display. See “Display(s)” section. On some models, reset the clock, if needed. See “Clock” section.
- **Is the display showing a letter followed by a number?** Depending on your model, press CANCEL, OFF or CANCEL/OFF to clear the display. See “Display(s)” section. If it reappears, call for service. See “Assistance or Service” section.

Self-Cleaning cycle will not operate

- **Is the oven door open?** Close the oven door all the way.
- **Has the function been entered?** See “Self-Cleaning Cycle” section.
- **On some models, has a delay start Self-Clean cycle been set?** See “Self-Cleaning Cycle” section.
- **Has a delay start been set?** See “Timed Cooking” section.

Oven cooking results not what expected

- **Is the appliance level?** Level the appliance. See the Installation Instructions.
- **Is the proper temperature set?** Double-check the recipe in a reliable cookbook.
- **Is the proper oven temperature calibration set?** See “Oven Temperature Control” section.
- **Was the oven preheated?** See “Baking and Roasting” section.
- **Is the proper bakeware being used?** See “Bakeware” section.
- **Are the racks positioned properly?** See “Positioning Racks and Bakeware” section.
- **Is there proper air circulation around bakeware?** See “Positioning Racks and Bakeware” section.
- **Is the batter evenly distributed in the pan?** Check to make sure batter is level in the pan.
- **Is the proper length of time being used?** Adjust cooking time.
- **Has the oven door been opened while cooking?** Oven peeking releases oven heat and can result in longer cooking times.
- **Are baked items too brown on the bottom?** Move rack to higher position in the oven.
- **Are pie crust edges browning early?** Use aluminum foil to cover the edge of the crust.

ASSISTANCE OR SERVICE

Before calling for assistance or service, please check “Troubleshooting.” It may save you the cost of a service call. If you still need help, follow the instructions below.

When calling, please know the purchase date and the complete model and serial number of your appliance. This information will help us to better respond to your request.

If you need replacement parts

If you need to order replacement parts, we recommend that you only use FSP® replacement parts. FSP® replacement parts will fit right and work right because they are made with the same precision used to build every new WHIRLPOOL® appliance.

To locate FSP® replacement parts in your area, call our Customer Interaction Center telephone number or your nearest Whirlpool designated service center.

In the U.S.A.

Call the Whirlpool Customer Interaction Center toll free: **1-800-253-1301**.

Our consultants provide assistance with:

- Features and specifications on our full line of appliances.
- Installation information.
- Use and maintenance procedures.
- Accessory and repair parts sales.
- Specialized customer assistance (Spanish speaking, hearing impaired, limited vision, etc.).
- Referrals to local dealers, repair parts distributors, and service companies. Whirlpool designated service technicians are trained to fulfill the product warranty and provide after-warranty service, anywhere in the United States.

To locate the Whirlpool designated service company in your area, you can also look in your telephone directory Yellow Pages.

For further assistance

If you need further assistance, you can write to Whirlpool Corporation with any questions or concerns at:

Whirlpool Brand Home Appliances
Customer Interaction Center
553 Benson Road
Benton Harbor, MI 49022-2692

Please include a daytime phone number in your correspondence.

Accessories U.S.A.

To order accessories, call the Whirlpool Customer Interaction Center toll free at **1-800-442-9991** and follow the menu prompts. Or visit our website at www.whirlpool.com and click on “Buy Accessories Online.”

Stainless Steel Cleaner & Polish

(stainless steel models)

Order Part #4396095

In Canada

For product related questions, please call the Whirlpool Canada Inc. Customer Interaction Center toll free: **1-800-461-5681**
Monday to Friday 8:00 a.m. - 6:00 p.m. (EST).
Saturday 8:30 a.m. - 4:30 p.m. (EST).

Our consultants provide assistance with:

- Features and specifications on our full line of appliances.
- Referrals to local dealers.

For parts, accessories and service in Canada

Call **1-800-807-6777**. Whirlpool Canada Inc. designated service technicians are trained to fulfill the product warranty and provide after-warranty service, anywhere in Canada.

For further assistance

If you need further assistance, you can write to Whirlpool Canada Inc. with any questions or concerns at:

Customer Interaction Center
Whirlpool Canada Inc.
1901 Minnesota Court
Mississauga, Ontario L5N 3A7

Please include a daytime phone number in your correspondence.

WHIRLPOOL® GAS COOKTOP AND RANGE WARRANTY

ONE-YEAR FULL WARRANTY

For one year from the date of purchase, when this appliance is operated and maintained according to instructions attached to or furnished with the product, Whirlpool Corporation will pay for FSP® replacement parts and repair labor to correct defects in materials or workmanship. Service must be provided by a Whirlpool designated service company.

SECOND THROUGH FIFTH YEAR LIMITED WARRANTY ON GAS RANGES AND GAS COOKTOPS

On gas ranges and gas cooktops, in the second through fifth years from the date of purchase, when this appliance is operated and maintained according to instructions attached to or furnished with the product, Whirlpool Corporation will pay for FSP® replacement parts for any gas burner to correct defects in materials or workmanship.

Whirlpool Corporation will not pay for:

1. Service calls to correct the installation of your appliance, to instruct you how to use your appliance, to replace house fuses or correct house wiring, or to replace owner-accessible light bulbs.
 2. Repairs when your appliance is used in other than normal, single-family household use.
 3. Pickup and delivery. Your appliance is designed to be repaired in the home.
 4. Damage resulting from accident, alteration, misuse, abuse, fire, flood, improper installation, acts of God or use of products not approved by Whirlpool Corporation or Whirlpool Canada Inc.
 5. Repairs to parts or systems resulting from unauthorized modifications made to the appliance.
 6. Replacement parts or repair labor costs for units operated outside the United States or Canada.
 7. In Canada, travel or transportation expenses for customers who reside in remote areas.
 8. Any labor costs during limited warranty period.
-

WHIRLPOOL CORPORATION AND WHIRLPOOL CANADA INC. SHALL NOT BE LIABLE FOR INCIDENTAL OR CONSEQUENTIAL DAMAGES.

Some states or provinces do not allow the exclusion or limitation of incidental or consequential damages, so this exclusion or limitation may not apply to you. This warranty gives you specific legal rights and you may also have other rights which may vary from state to state or province to province.

Outside the 50 United States and Canada, this warranty does not apply. Contact your authorized Whirlpool dealer to determine if another warranty applies.

If you need service, first see the "Troubleshooting" section of this book. After checking "Troubleshooting," additional help can be found by checking the "Assistance or Service" section or by calling the Whirlpool Customer Interaction Center, **1-800-253-1301** (toll-free), from anywhere in the U.S.A. For parts and service in Canada, please call **1-800-807-6777**. For product related questions in Canada, please call **1-800-461-5681**.

5/00

Keep this book and your sales slip together for future reference. You must provide proof of purchase or installation date for in-warranty service.

Write down the following information about your appliance to better help you obtain assistance or service if you ever need it. You will need to know your complete model number and serial number. You can find this information on the model and serial number label/plate, located on your appliance as shown in the "Parts and Features" section.

Dealer name _____
Address _____
Phone number _____
Model number _____
Serial number _____
Purchase date _____

