



NO-FROST REFRIGERATOR-FREEZER

Model ED19AK

ED19TK

EHD192XK

EHD192VK

Use and Care Guide

Safety First

Child entrapment, and suffocation, are not things of the past. Junked or abandoned refrigerators are still dangerous...even if they will "just sit in the garage a few days." If you are getting rid of your old refrigerator, do it safely. Please read the enclosed safety booklet from the Association of Home Appliance Manufacturers. Help prevent accidents.

- Power-Saving Control
- Freezer Light
- Air Control Light
- Temperature Control
- Utility Compartment
- Adjustable Shelves
- Ice Cube Trays
- Utility Bin
- Crisper
- Meat Pan
- Meat Pan Air Control (not shown)
- Freezer Storage Bin
- Base Grille

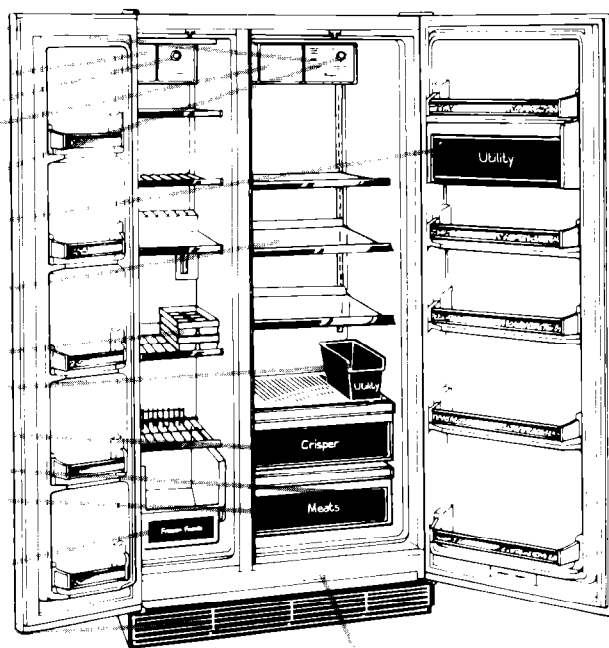

Copy Your Model Number and Serial Number Here

Model and Serial Number Plate

When you need service, or call with a question, have this information ready:

1. **Complete** Model and Serial Numbers (from the plate just above base grille).
2. Purchase date from sales slip.

Copy this information in these spaces. Keep this book, your warranty and sales slip together in a handy place.

Model Number
Serial Number
Purchase Date
Service Company and Telephone Number

Please read this Use and Care Guide before you do anything else...

This booklet tells you how to start your refrigerator, clean it, move shelves and adjust controls. It even tells you what to do if you hear strange sounds or think something is wrong.

Treat your new refrigerator with care. Use it only to do what home refrigerators are designed to do.

CONTENTS

BEFORE YOU PLUG IT IN	2	Removing the Freezer Bin	6
Install Properly	3	Removing the Base Grille	6
Level Refrigerator-Freezer	3	Sounds You May Hear	6
Remove Sales Labels	3	Energy Saving Tips	6
Clean It	3	CLEANING YOUR REFRIGERATOR	7
Plug It In	3	Cleaning Chart	7
USING YOUR REFRIGERATOR	4	FOOD STORAGE GUIDE	8
Setting the Controls	4	Storing Fresh Food	8
Adjusting Shelves	4	Storing Frozen Food	9
Removing Freezer Shelves	5	VACATION AND MOVING CARE	10
Removing the Crisper, Meat Pan	5	IF YOU NEED SERVICE OR ASSISTANCE ..	11
and Covers	5	1. Before Calling for Assistance	11
Changing Light Bulbs	5	2. If You Need Assistance	11
Ice Cube Trays	5	3. If You Need Service	11
Optional Automatic Ice Maker	5	4. If You Have a Problem	11

©1984 Whirlpool Corporation

Before you plug it in

IMPORTANT

Before using your refrigerator, you are personally responsible for making sure that it...

- is installed and leveled on a floor that will hold the weight, and in an area suitable for its size and use.
- is connected only to the right kind of outlet, with the right electric supply and grounding.
- is used only for jobs expected of home refrigerators.
- is not near an oven, radiator or other heat source.
- is properly maintained.
- is out of the weather.
- is used in an area where the room temperature will not fall below 55° F (13° C).
- is not run where there are explosive fumes.
- is not used by children or others who may not understand how it should be used.
- is not loaded with food before it has time to get properly cold.

Install Properly...

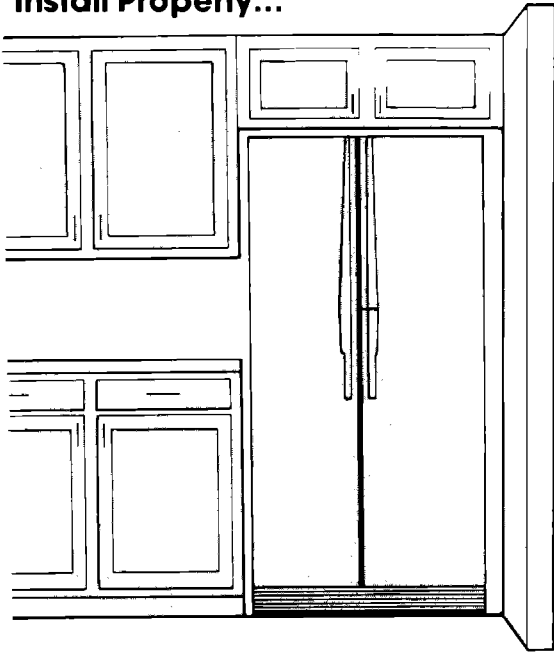

1. Allow 1/2 inch (1.3 cm) space between counters and cabinets and the sides and top of the refrigerator for ease of installation.
2. If the refrigerator is to be against a wall, you might want to leave enough space so the door can be opened wider.
3. The refrigerator back can be flush against the wall.

Level Refrigerator-Freezer...

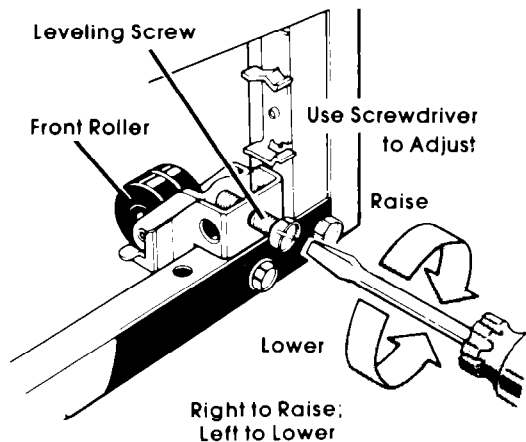

1. Remove base grille (see page 6).
2. To raise front, turn each screw to the right.
3. To lower front, turn each screw to the left.
4. Check with level.

Remove Sales Labels...

Remove the Consumer Buy Guide label and any inside sales labels before using the refrigerator. Remove any left over glue with rubbing alcohol.

Clean It...

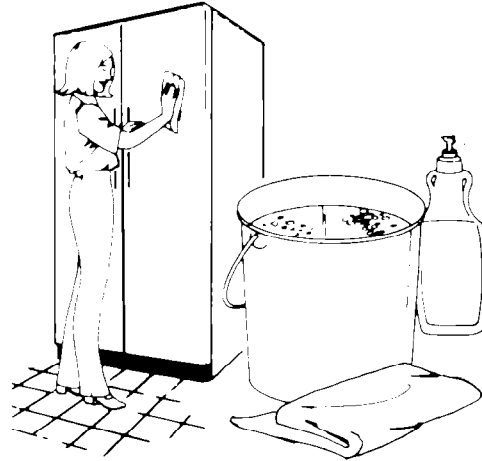

Clean your refrigerator before using it. See cleaning instructions on page 7.

Plug It In...

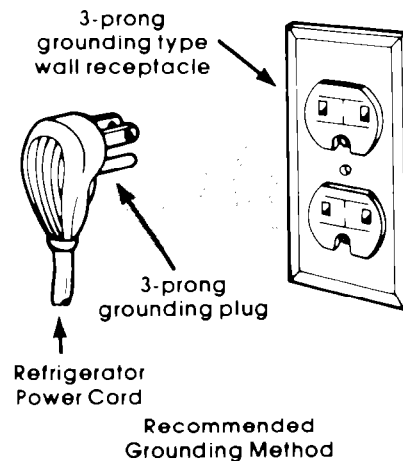

A 115 Volt, 60 Hz., AC only, 15 or 20 ampere fused and grounded electrical supply is required. It is recommended that a separate circuit serving only this appliance be provided.

Do not use an extension cord. Use a receptacle which cannot be turned off with a switch or pull chain. See individual electrical requirements and grounding instruction sheet in your literature package.

BEFORE YOU PLUG IT IN

Using your refrigerator

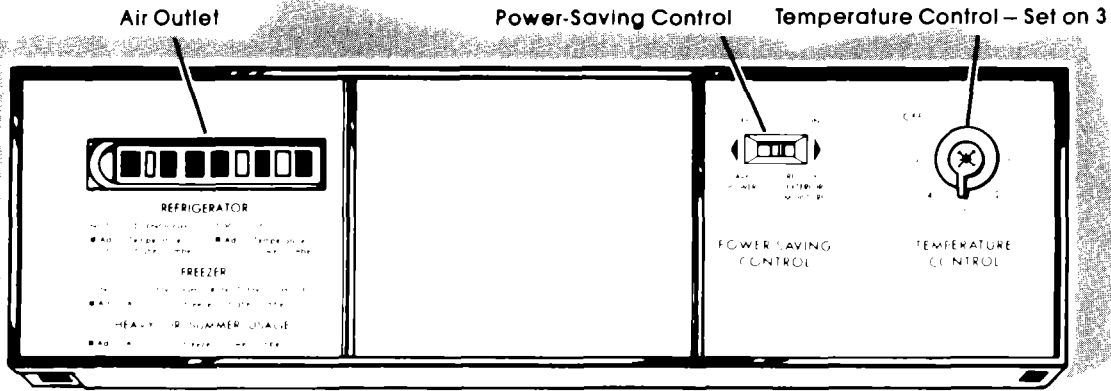

Setting the Controls...

Controls for adjusting temperatures are in both the refrigerator and the freezer.

To start:

1. Set the TEMPERATURE CONTROL (in the refrigerator) to 3.
2. Set the AIR CONTROL (in the freezer) to 3.

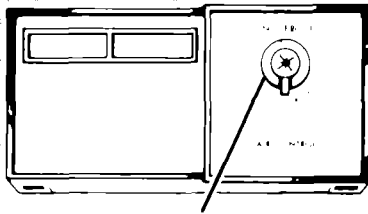

Air Control – Set on 3

Give the refrigerator time to cool down completely before adding food. (This may take several hours). The control console has directions for adjusting temperatures, if needed. Controls will be set about right if your milk or juice is as cold as your family likes it, and when ice cream is firm.

Do not block the air outlets on either control panel. That can slow the air movement needed to keep temperatures at the level you set.

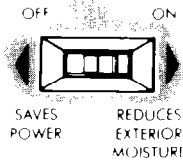

Off Setting Helps Save Energy

- Use the OFF setting when humidity is low.
- Use ON if moisture forms on the outside of the refrigerator.

The POWER SAVING CONTROL on the control panel in the refrigerator operates electric heaters. These heaters help prevent moisture from forming on the outside of the refrigerator when humidity is high.

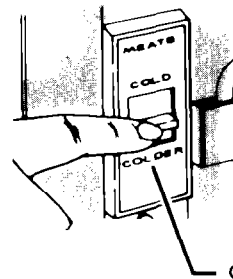

The Meat Pan Air Control...

Cold air flows against the meat pan through an opening between the freezer and the refrigerator. This helps keep the meat pan colder than the rest of the refrigerator.

Set the control to let more or less cold air through.

Colder Meat Storage

Use Control to Adjust Meat Pan Temperatures

Adjusting Shelves...

Shelves can be adjusted to match the way you use your refrigerator.

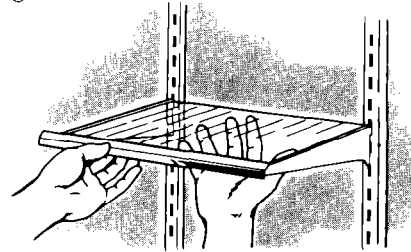

If your model has glass shelves, be careful. They are heavy.

To remove shelves:

1. Tilt up at front.
2. Lift up at back.
3. Pull shelf straight out.

To replace:

1. Guide the rear hooks into the slots in the shelf supports.
2. Tilt up front of shelf until hooks drop into slot. Lower front of shelf to level position.

Removing Freezer Shelves...

- Lift front slightly
- Lift back off supports.
- Replace in reverse order.

Lift the Front
Then the Back

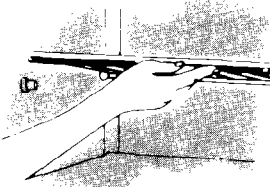

Removing the Crisper, Meat Pan and Covers...

- Slide crisper and meat pan straight out to stop
- Lift the front.
- Slide the rest of the way out.
- Replace in reverse order

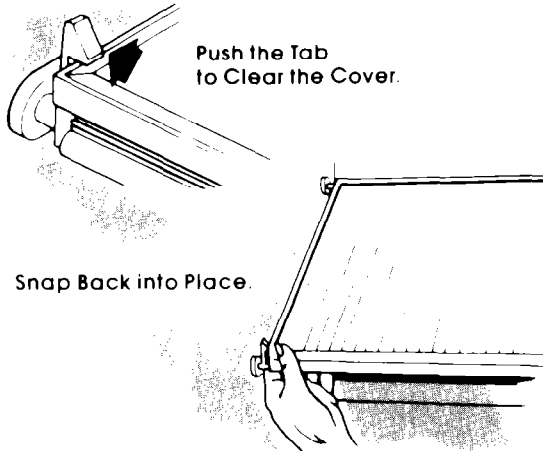

Push the Tab
to Clear the Cover.

Snap Back into Place.

- Covers are held in place by two pegs at the back and two notched tabs in front.
 - Press front tabs out of the way.
 - Lift cover front.
 - Lift back off the pegs
 - Replace in reverse order

Changing Light Bulbs...

Before removing a light shield for cleaning or for replacing a bulb, **unplug the refrigerator.** Use *appliance bulbs only*

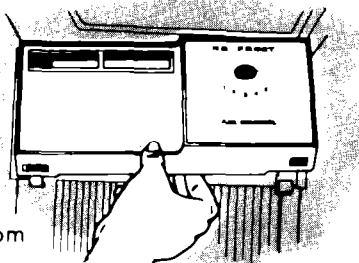

Pull Off the Dial.
Pull Out at the Bottom

Light bulbs behind refrigerator and freezer control consoles:

- Pull control knob straight off
- Pull bottom of control panel straight out.
- Lift top of panel off supports
- Replace with a 40-watt appliance bulb.
- Replace panel in reverse order.

Ice Cube Trays...

To remove ice:

- Hold tray at both ends.
- Slightly twist

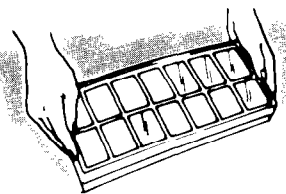

If cubes are not used, they may shrink. The moving cold air starts a slow evaporation. The longer cubes are stored, the smaller they get.

Optional Automatic Ice Maker...

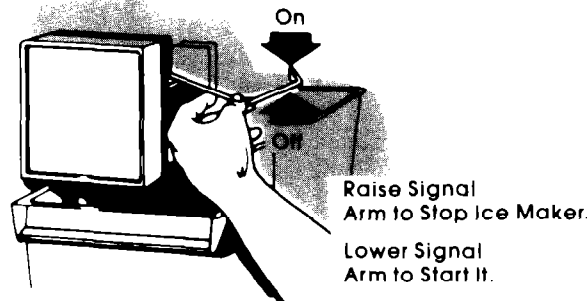

Raise Signal
Arm to Stop Ice Maker.
Lower Signal
Arm to Start It.

If you have the automatic ice maker accessory or plan to add one later (Part No. ECKMF-6), there are a few things you will want to know:

- The ON/OFF lever is a wire signal arm.
 - Down...for making ice automatically;
 - Up...to shut off the ice maker.
- Shake the bin occasionally to keep cubes separated, and to obtain increased storage capacity.
- It is normal for ice crescents to be attached by a corner. They will break apart easily.
- You will hear water running when ice maker is working. You'll hear ice fall into the bin. Don't let these sounds bother you.
- The ice maker will not operate until the freezer is cold enough to make ice. This can take overnight.
- Because of new plumbing connections, the first ice may be discolored or off-flavored. Discard the first few batches of ice.
- If ice is not being made fast enough and more ice is needed, turn the Temperature control to a higher number. Wait a day and, if necessary, turn the Air Control to a higher number.
- If you remove the ice bin, raise the signal arm to shut off the ice maker. When you return the bin, push it all the way in and lower the arm to the ON position.
- If cubes are stored too long, they may develop an off-flavor...like stale water. Throw them away. They will be replaced. Cubes in the ice bin can also become smaller by evaporation.

Removing the Freezer Bin...

For proper air movement, keep the freezer bin in place when the refrigerator is operating.

To remove the bin:

- Slide out to the stop.
- Lift the front to clear the stop.
- Slide out the rest of the way.

To replace the bin:

- Place bin on the slides.
- Make sure the stops clear the front of the slides.
- Slide bin in.

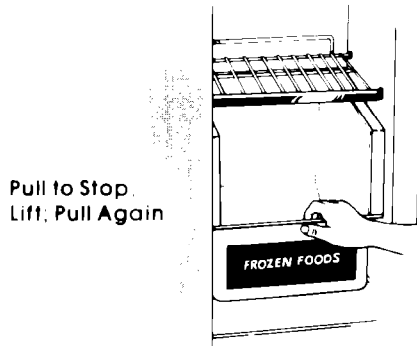

Removing the Base Grille...

- Open the doors.

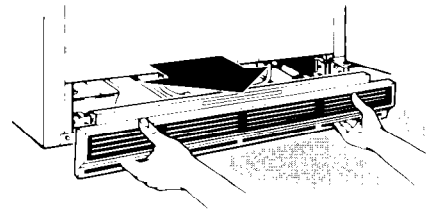

- Pull grille outwards as shown.
- **Do not remove Tech sheet** fastened behind grille.

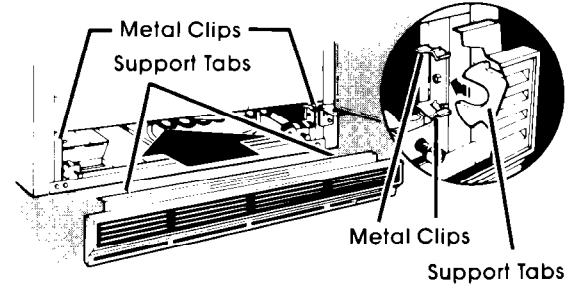

To replace:

- Line up grille support tabs with metal clips.
- Push firmly to snap into place.
- Close the doors.

Sounds you may hear.

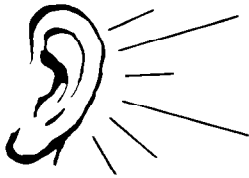

Your new refrigerator may make sounds that your old one didn't. Because the sounds are new to you, you might be concerned about them. Don't be. Most of the new sounds are normal. Hard surfaces like the floor, walls and cabinets can make the sounds seem louder.

The following chart describes the kinds of sounds that might be new to you, and what may be making them.

Possible Sounds:

- Slight Hum, Soft Hiss:

Probable Causes:

Your refrigerator has two fans; you may hear the fan motors and moving air.

- Clicking or Snapping Sounds:

The defrost timer makes a definite click when the refrigerator stops running. It also makes a sound when the refrigerator starts.

- Water Sounds:

When the refrigerator stops running, you may hear gurgling in the tubing for a few minutes after it stops. You may also hear defrost water running into the defrost water pan.

- Ice Maker Sounds:

If your refrigerator has an ice maker, you may hear buzzing (from the water valve), trickling water and the clatter of ice dumped into the bin.

- Running Sounds:

Your refrigerator has a high-efficiency compressor and motor. It will run longer than older designs. It may even seem to run most of the time.

Energy Saving Tips

You can help your refrigerator use less electricity.

- Check door gaskets for a tight seal. Level the cabinet to be sure of a good seal.
- Clean the condenser coil regularly.
- Open the door as few times as possible. Think about what you need before you open the door. Get everything out at one time. Keep foods organized so you won't have to search for what you want. Close door as soon as food is removed.
- Go ahead and fill up the refrigerator, but don't overcrowd it so air movement is blocked.
- It is a waste of electricity to set the refrigerator and freezer to temperatures colder than they need to be. If ice cream is firm in the freezer and drinks are as cold as your family likes them, that's cold enough.
- Keep the Power Saving Control on OFF unless moisture forms on the refrigerator exterior.
- Make sure your refrigerator is not next to a heat source such as a range, water heater, furnace, radiator, or in direct sunlight.

Cleaning your refrigerator

Part	What to use	How to clean
Removable parts (shelves, crisper, meat pan, etc.)	Mild detergent and warm water.	<ul style="list-style-type: none"> • Wash removable parts with warm water and a mild detergent. • Rinse and dry.
Outside	Sponge, cloth or paper towel; mild detergent; appliance wax (or good auto paste wax).	<ul style="list-style-type: none"> • Wash with warm water and a mild detergent. Do not use abrasive or harsh cleansers. • Rinse and dry. • Wax painted metal surfaces at least twice a year with appliance wax or a good auto paste wax. Apply wax with a clean, soft cloth. Do not use wax on plastic parts.
	Waxing painted metal surfaces provides rust protection.	
Inside walls (Freezer should be allowed to warm up so cloth won't stick.)	Sponge, soft cloth or paper towel, baking soda, warm water, mild detergent.	<ul style="list-style-type: none"> • Wash with warm water and mild detergent or – baking soda (2 tablespoons [26 g] to 1 quart [.95 l] warm water). • Rinse and dry.
Door liners and gaskets	Sponge, soft cloth or paper towel; mild detergent, warm water.	<ul style="list-style-type: none"> • Wash with mild detergent and warm water. • Rinse and dry.
	DO NOT USE Cleaning waxes, concentrated detergents, bleaches or cleansers containing petroleum on plastic parts.	
Dark plastics	Mild detergent and warm water; soft, clean sponge and soft, clean cloth.	<ul style="list-style-type: none"> • Wash with a soft grit-free cloth or sponge. • Rinse and dry with a damp grit-free cloth or chamois.
	DO NOT USE paper towels, window sprays, scouring cleansers, or flammable or toxic solvents like acetone, gasoline, carbon tetrachloride, etc. These can scratch or damage the material.	
Defrost pan	Warm water and mild detergent.	<ul style="list-style-type: none"> • Remove base grille (See page 6). • To remove defrost pan, lift pan over wire brace (remove tape, if any). • Wash defrost pan with warm water and mild detergent. • Rinse and dry. • Replace with notched corner to the rear. • Push it all the way in. • Make sure defrost drain tube is pointing into pan.
Condenser Coil	Vacuum cleaner; using the extended narrow attachment.	<ul style="list-style-type: none"> • Remove base grille. • Clean dust and lint from condenser at least every other month. • Replace base grille.
Floor under refrigerator	Usual floor cleaners.	<ul style="list-style-type: none"> • Roll refrigerator out only as far as water supply line allows. • Wash floor. • Roll refrigerator back. • Check to see if the refrigerator is level.

USING YOUR REFRIGERATOR

CLEANING YOUR REFRIGERATOR

Food storage guide

STORING FRESH FOOD



There is a right way to package and store refrigerated or frozen foods. To keep foods fresher, longer, take the time to study these recommended steps.

Leafy Vegetables ...Remove store wrapping. Trim or tear off bruised and discolored areas. Wash in cool water, drain and store in crisper. Cold, moist air helps keep leafy vegetables fresh and crisp. The crisper has sealing gaskets to help keep humid air in.

Vegetables with Skins (carrots, peppers) ...Store in crisper, plastic bags or plastic container.

Fruits ...Wash, let dry and store in refrigerator in plastic bags or crisper. Do not wash or hull berries until they are ready to use. Sort and keep berries in their store container in a crisper, or store in a loosely closed paper bag on a refrigerator shelf.



Meat ... Meat is perishable and expensive...you won't want to waste an ounce of it through careless handling. The following list and chart give you packaging hints and time limits. Store meat in the meat pan.

Fresh, Prepackaged Meat...Store fresh meat in the store wrapping. Vacuum packaged meat can be frozen for as long as one month if the seal is not broken. If you want to keep it frozen longer, you should wrap it with special freezer wrapping material.

Fresh Meat, Not Prepackaged. Remove the market wrapping paper and re-wrap loosely in waxed paper or aluminum foil for storing it unfrozen.

Cooked Meat. Wrap or cover cooked meat with waxed paper, plastic wrap or aluminum foil. Store immediately.

Cured or Smoked Meat and Cold Cuts. Ham, bacon, sausage, cold cuts, etc., keep best in original wrappings. Once opened, tightly re-wrap in plastic wrap or aluminum foil.

Canned Ham. Store in refrigerator unless the label says it's okay to store on the shelf. Do not freeze.

Fresh Poultry...Loosely wrap in waxed paper or plastic wrap. The plastic wrap on poultry, as purchased, may be used for storage.

STORAGE CHART FOR FRESH AND CURED MEAT*

Type	Approximate Time (days)
Variety Meats	1 to 2
Chicken	1 to 2
Ground Beef	1 to 2
Steaks and Roasts	3 to 5
Cured Meats	7 to 10
Bacon	5 to 7
Cold Cuts	3 to 5

*If meat is to be stored longer than the times given, follow the directions for freezing.

NOTE: Fresh fish and shellfish should be used the same day as purchased.

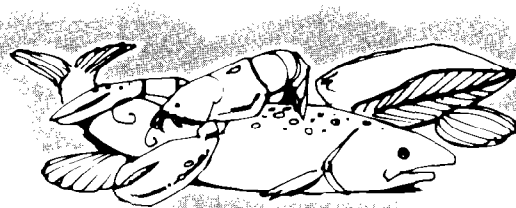

Eggs ...Store without washing in the original carton or use the Utility Bin that came with your refrigerator.

Milk...Wipe milk cartons. For best storage, place milk on interior shelf or bottom door shelf.

Beverages...Wipe bottles and cans. Store on a door shelf or inside the refrigerator.

Butter...Keep opened butter in covered dish or in the Butter Compartment. When storing an extra supply, wrap in freezer packaging and freeze.

Cheese ...Store in the original wrapping until you are ready to use it. Once opened, re-wrap tightly in plastic wrap or aluminum foil.

Condiments ...Store small jars and bottles (cat-sup, mustard, jelly, olives) on the door shelves where they are in easy reach.

Leftovers...Cover leftovers with plastic wrap or aluminum foil to keep food from drying out and transferring food odors. Plastic containers with tight lids are fine, too.

STORING FROZEN FOOD

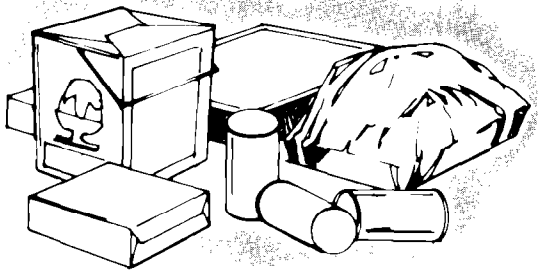

The freezer section is designed for storage of commercially frozen foods and for freezing foods at home.

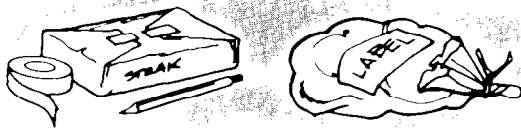

Packaging – The secret of successful freezing is in the packaging. The wrap you use must be air, moisture and vapor proof. The way you close and seal the package must not allow air, moisture or vapors in or out.

Rigid polyethylene (plastic) containers with tight-fitting lids, straight-sided canning freezing jars, heavy-duty aluminum foil, plastic-coated paper and non-permeable plastic wraps (such as saran) are recommended. Note: Heat-sealed boiling bags are easy to use and can be used by themselves or as carton liners.

IMPORTANT: Do not expect your freezer to quick-freeze any large quantity of food. Leave enough space for air to circulate around packages. Be careful to leave enough room at the front so the door can close tightly.

Ice Cream...Store in the freezer. Once the package is opened, place a piece of aluminum foil or waxed paper smoothly against the ice cream surface. This will prevent ice crystals from forming.

Packaged Frozen Food ... Store on freezer door shelf or in the freezer. If you plan to store it for a long time, re-wrap it with aluminum foil or plastic wrap.

Frozen Meats ... The following hints will help keep the quality in your frozen meats:

1. Freeze meat while fresh and in top condition.
2. Use only the recommended wrapping materials.
3. Prepare the meat for freezing before wrapping it. Trim off excess fat and remove bones when practical. Meat should not be salted because salt shortens freezer life.
4. Wrap tightly, pressing out as much air as possible.
5. Label and date it.
6. Refreezing defrosted meat is not recommended.

Frozen Soups, Juices ... Store on freezer door shelf or in the freezer.

STORAGE CHART FOR FROZEN FOOD

Storage times given in this chart are only a guide. For best use of freezer space, keep frozen foods for short times. Use, then replace as needed.

Bread	2 months
Cooked Dishes	2-3 months
Fish and Seafoods	
Fresh	6 months
Commercially Frozen	1-3 months
Fruits	6 months
Ice Cream	1 month
Concentrated Juice	4-6 months
Meats	
Bacon	Less than 1 month
Pork roasts, chops	3-4 months
Sausage	1-2 months
Beef, veal, lamb roasts	6 months
Ground meat	1-2 months
Poultry	3-4 months
Vegetables	6 months

*Courtesy of National Live Stock and Meat Board and U.S.D.A.

Vacation and moving care



Short Vacations.

No need to shut off the refrigerator if you will be away for less than four weeks. Use up perishables, freeze other items. If your refrigerator is equipped with an automatic ice maker, 1) turn it off; 2) shut off the water supply to the ice maker; 3) empty the ice bin.

Long Vacations.

Remove all the food if you are going for a month or more. If your refrigerator is equipped with an automatic ice maker, turn off the water supply to the ice maker at least a day ahead. When the last load of ice drops, turn off the ice maker.

Unplug the refrigerator and clean it...rinse well and dry. Tape rubber or wood blocks to both doors...keeping them open far enough for air to get in. This will keep odor and mold from building up.

Tape the blocks out of a child's reach...do not allow children near the refrigerator when the doors are blocked open.

To restart refrigerator, see "Using Your Refrigerator."

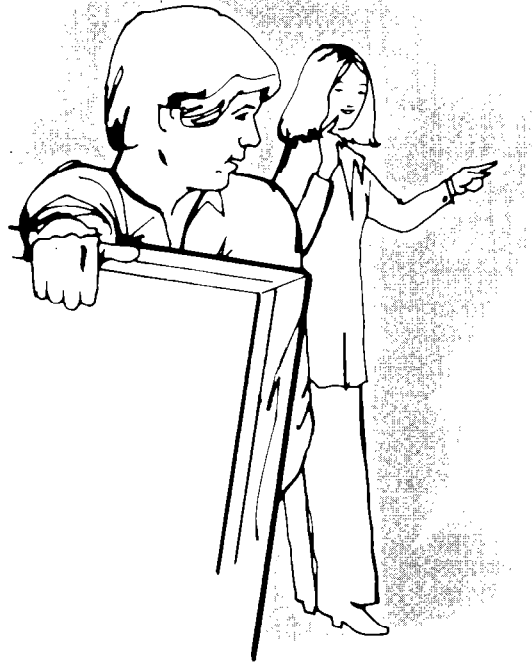

Moving.

If your refrigerator is equipped with an automatic ice maker, shut off the ice maker water supply a day ahead of time. Disconnect the water line. After the last supply of ice drops, lift the signal arm to turn off the ice maker.

Remove all food. Pack frozen foods in dry ice. Unplug the refrigerator and clean it thoroughly.

Remove everything that comes out. Wrap all parts well and tape them together so they don't shift and rattle.

Screw in the levelling rollers, tape the doors shut; tape the electric cord to the cabinet. When you get to your new home, put everything back, and refer to page 3. Don't forget to reconnect the water supply line if you have an icemaker.

QUESTIONS?

...call your
COOL-LINE®
service
assistance
telephone
number
(page 11).



If you need service or assistance, we suggest you follow these four steps:

1. Before calling for assistance...

Performance problems often result from little things you can find and fix yourself without tools of any kind.

If your refrigerator will not operate:

- Is the electric cord plugged in?
- Is a fuse blown or a circuit breaker tripped?
- Is the Temperature Control turned ON?

If your ice maker will not operate:

- Has the freezer had enough time to get cold? With a new refrigerator, this might take overnight.
- Is the signal arm ON...in the down position?
- Is the water valve turned on? Is water getting to the ice maker?

If there is a rattling or jingling noise, or other unfamiliar sounds:

- Is something on top or behind the refrigerator making noise when the refrigerator is running?
- New features on your new refrigerator make new sounds. You may be hearing air flowing from the fans, timer clicks for the defrosting cycle, defrost water draining into the defrost pan.

If there is water in the defrost pan:

- In hot, muggy weather, this is normal. The pan can even be half full. Make sure the refrigerator is level so the pan doesn't overflow.

If the lights aren't working:

- Check fuses and circuit breakers. Make sure it's plugged in.

If a bulb is burned out:

- See instructions for changing light bulbs on page 5. Use appliance bulbs only.

If the motor seems to run too much:

- Is the condenser, behind the base grille, free of dust and lint?
- On hot days, or if the room is warm, the motor naturally runs longer.
- If the door has been opened a lot, or if a large amount of food has been put in, the motor will run longer to cool down the interior.

Remember: Motor running time depends on different things: number of door openings, amount of food stored, temperature of the room, setting of the controls.

And, your new refrigerator may be larger than your old one so it has more space to be cooled. It also has a regular freezer instead of a frozen food compartment. All this means better refrigeration and may require more running time than your old one.

2. If you need assistance*...

Call Whirlpool COOL-LINE® service assistance telephone number. Dial free from:

- Continental U.S. (800) 253-1301
 Michigan (800) 632-2243
 Alaska & Hawaii (800) 253-1121

and talk with one of our trained Consultants. The Consultant can instruct you in how to obtain satisfactory operation from your appliance or, if service is necessary, recommend a qualified service company in your area.

3. If you need service*...



Whirlpool has a nationwide network of franchised TECH-CARE® Service Companies. TECH-CARE service technicians are trained to fulfill the product warranty and provide after-warranty service, anywhere in the United States. To locate

TECH-CARE service in your area, call our COOL-LINE service assistance telephone number (see Step 2) or look in your telephone directory Yellow Pages under

APPLIANCES—HOUSEHOLD— MAJOR—SERVICE & REPAIR WHIRLPOOL APPLIANCES FRANCHISED TECH-CARE SERVICE SERVICE COMPANIES XYZ SERVICE CO. 123 Maple 499-9999	OR	ELECTRICAL APPLIANCES— MAJOR—REPAIRING & PARTS WHIRLPOOL APPLIANCES FRANCHISED TECH-CARE SERVICE SERVICE COMPANIES XYZ SERVICE CO. 123 Maple 999-9999
OR WASHING MACHINES, DRYERS & IRONERS—SERVICING WHIRLPOOL APPLIANCES FRANCHISED TECH-CARE SERVICE SERVICE COMPANIES XYZ SERVICE CO. 123 Maple 999-9999		

4. If you have a problem*...

Call our COOL-LINE service assistance telephone number (see Step 2) and talk with one of our Consultants, or if you prefer, write to:

Mr. Guy Turner, Vice President
 Whirlpool Corporation
 Administrative Center
 2000 US-33 North
 Benton Harbor, MI 49022

If you must call or write, please provide model number, serial number, date of purchase, and a complete description of the problem. This information is needed in order to better respond to your request for assistance.

VACATION AND MOVING CARE

IF YOU NEED SERVICE OR ASSISTANCE



FSP is a registered trademark of Whirlpool Corporation for quality parts. Look for this symbol of quality whenever you need a replacement part for your Whirlpool appliance.

FSP replacement parts will fit right and work right, because they are made to the same exacting specifications used to build every new Whirlpool appliance.



Benton Harbor, Michigan. Automatic Washers, Clothes Dryers, Freezers, Refrigerator-Freezers, Ice Makers, Dishwashers, Built-in Ovens and Surface Units, Ranges, Microwave Ovens, Compactors, Room Air Conditioners, Dehumidifiers, Central Heating and Air Conditioning Systems.

Making your world a little easier.