

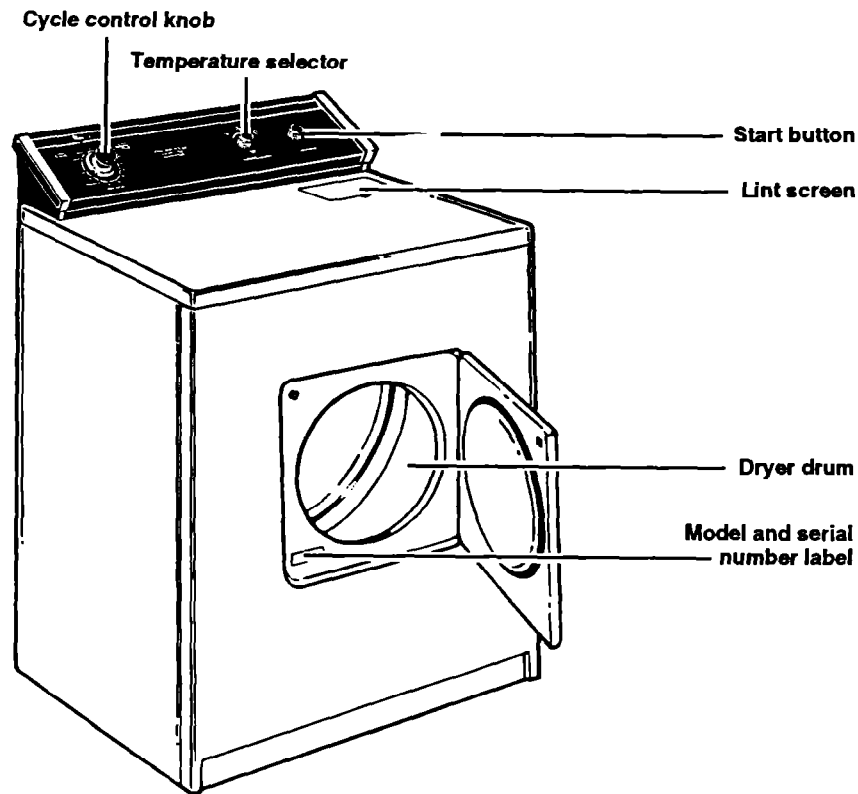

Use & Care Guide



**EXTRA LARGE CAPACITY
AUTOMATIC DRYERS
LE7760XW LG7761XW**

Contents

	Page
Important Safety Instructions	3
Additional safety instructions and your responsibilities	4
Operating Instructions	
Starting your dryer	5
The automatic cycles	7
Timed drying	8
Using TUMBLE PRESS®	8
Using fluff air	9
Caring For Your Dryer	
Cleaning the lint screen	10
Lint screen maintenance	10
Cleaning the dryer	11
Lint removal	12
If You Need Service Or Assistance	14
Whirlpool Automatic Dryer Warranty	16

©1992 Whirlpool Corporation

If your dryer has a Consumer Buy Guide label, remove it. It will be easier to remove before the dryer is used. To remove any remaining glue:

- Rub briskly with thumb to make a ball, then remove.
or
- Soak area with liquid hand dishwashing detergent before removing glue as described above.

Do not use sharp instruments, rubbing alcohol, flammable fluids or abrasive cleaners. These can damage the finish. See "Important Safety Instructions" on page 3.

NOTE: Do not remove any permanent instruction labels inside the dryer.

You should wipe out the dryer drum with a damp cloth before using to remove dust from storing or shipping.

Thank you for buying a Whirlpool appliance. Please complete and mail the Owner Registration Card provided with this product. Then complete the form below. Have this information ready if you need service or call with a question.

- Copy model and serial numbers from label (on the frame behind the door) and purchase date from sales slip.
- Keep this book, the Dryer Guide and the sales slip together in a handy place.

Model Number

Serial Number

Purchase Date

Service Company Phone Number

Important Safety Instructions

⚠ WARNING

Fire Hazard

For your safety the information in this manual must be followed to minimize the risk of fire or explosion or to prevent property damage, personal injury or loss of life.

–Do Not store or use gasoline or other flammable vapors and liquids in the vicinity of this or any other appliance.

–**WHAT TO DO IF YOU SMELL GAS:**

- Do Not try to light any appliance.
- Do Not touch any electrical switch; Do Not use any phone in your building.
- Clear the room, building or area of all occupants.
- Immediately call your gas supplier from a neighbor's phone. Follow the gas supplier's instructions.
- If you cannot reach your gas supplier, call the fire department.

–Never install dryer up against draperies or curtains, or on carpet.

–Keep any and all items from falling or collecting behind the dryer.

Installation and service must be performed by a qualified installer, service agency or the gas supplier.

**Important Safety Instructions
Continued**

⚠ WARNING

To reduce the risk of fire, electrical shock, or injury to persons when using your dryer, follow basic precautions, including the following:

- **Read all instructions before using the dryer.**
- **NEVER** dry items cleaned, washed, soaked in or spotted with wax, paint, gasoline or flammable fluids in the dryer. The fumes can create a **FIRE HAZARD** or **EXPLOSION**. **ALWAYS** hand launder and air dry fabrics containing these materials.
- **NEVER** allow children to operate, play with or crawl inside the dryer. Close supervision of children is necessary when the dryer is used near children.
- **DO NOT** reach into a dryer if the drum is moving.
- When discarding an old dryer, **ALWAYS** remove the door to prevent accidental entrapment.
- **DO NOT** install or store dryer where it will be exposed to the weather.
- **DO NOT** tamper with the controls.
- **You are responsible for making sure that your dryer is installed, repaired and has parts replaced by a qualified person.**
- Use only fabric softeners specifically labeled as not being harmful to the dryer.
- **FIRE HAZARD** and **DAMAGE** to materials can result from:
 - drying rubber, rubber-like and heat sensitive materials with heat.
 - allowing lint build-up inside the dryer or exhaust system. Cleaning should be done periodically by a qualified person.
- Clean lint screen before or after each load.
- **DO NOT** let dust, lint, paper, rags, chemicals, etc. pile up around or under the dryer.
- Dryer must be electrically grounded. See the Installation Instructions.

– SAVE THESE INSTRUCTIONS –

Additional safety instructions and your responsibilities

- **NEVER** operate the dryer if:
 - it is not working right (i.e. noisy, too hot).
 - it is damaged.
 - parts are missing (i.e. door latch).
 - all panels are not in place.
 - the lint screen is loose, damaged or missing.
- **ALWAYS** shut off the gas valve before leaving on vacation if you have a gas dryer.
- **ALWAYS** unplug the power supply cord or turn off electrical power before attempting to service the dryer. Shut off **GAS VALVE** if you have a gas dryer.
- **You are responsible for making sure that your dryer:**
 - is properly maintained.
 - is properly installed and leveled on a floor that can support the weight in a well ventilated room.*
 - is located in an area where the temperature is above 45°F (7°C).
 - is connected to the proper outlet and electrical supply.*
 - is properly connected to fuel and exhaust systems.*
 - is not installed against drapes or curtains.*
 - is used only for jobs normally expected of home clothes dryers.
 - is not used by anyone unable to operate it properly.

*See the Installation Instructions for complete information.

Operating Instructions

Starting your dryer

Be sure to refer to the chart below and the Dryer Guide for proper sorting, loading and control setting information before starting your dryer.

NOTE: Do not overdry. Overdrying can cause shrinkage, static cling, and damage some fabrics.

TYPE OF LOAD	SUGGESTED CYCLE	SUGGESTED TEMPERATURE
Cottons and linens		
EXTRA HEAVY—Bedspreads, mattress pads, quilts	AUTOMATIC REGULAR	PERM'T PRESS HEAVY HIGH
HEAVYWEIGHT—Towels, jeans, corduroys, work clothes		
MEDIUMWEIGHT—Sheets, pillowcases, cotton underwear, diapers		
LIGHTWEIGHT—Batistes, organdies, lingerie		KNITS GENTLE LOW
Permanent press, synthetics and blends		
HEAVYWEIGHT—Work clothes, jackets, raincoats	AUTOMATIC PERMANENT PRESS	PERM'T PRESS HEAVY HIGH
MEDIUMWEIGHT—Shirts, play clothes, sheets, slacks		
LIGHTWEIGHT—Lingerie, blouses, dresses		KNITS GENTLE LOW
Knits		
HEAVYWEIGHT—Cottons, rayons, blends, T-shirts, slacks, shirts	AUTOMATIC PERMANENT PRESS	PERM'T PRESS HEAVY HIGH
MEDIUMWEIGHT—Synthetics (polyester, acrylic, etc.), dress slacks, skirts, sweaters		
LIGHTWEIGHT—Synthetics (polyester, acrylic, etc.) and blends, lingerie, blouses, dresses		KNITS GENTLE LOW
Delicate fabrics		
Sheer curtains (2 or 3 panels), gauze, lace, etc.	AUTOMATIC PERMANENT PRESS	KNITS GENTLE LOW

WARNING

Fire Hazard

Drying rubber, plastic and other heat-sensitive materials with heat can damage them or be a **FIRE HAZARD.**

Rubber, plastic, heat-sensitive fabrics	TIMED DRYING	
FOAM RUBBER—Pillows, bras, stuffed toys	20-30 min.	FLUFF AIR*
PLASTIC—Shower curtains, tablecloths	20-30 min.	
RUBBER-BACKED RUGS	40-50 min.	
OLEFIN, POLYPROPYLENE, SHEER NYLON	15-20 min.	

*See page 9.

IMPORTANT SAFETY INSTRUCTIONS • OPERATING INSTRUCTIONS

**Operating Instructions
Continued**

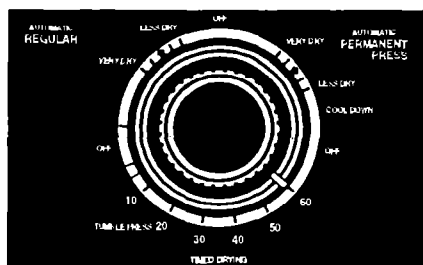

1. **Select a cycle** by turning the Cycle Control Knob either way. Stop when the indicator on the knob's outer ring points to the cycle and setting you want. See pages 7-8 for further cycle information.

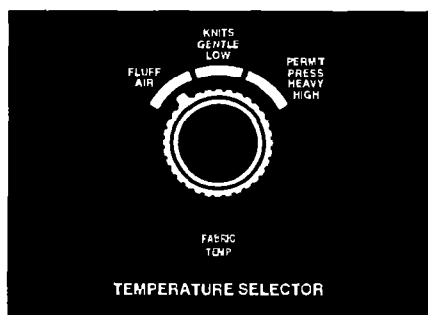

2. **Set the Temperature Selector** on the desired temperature setting.

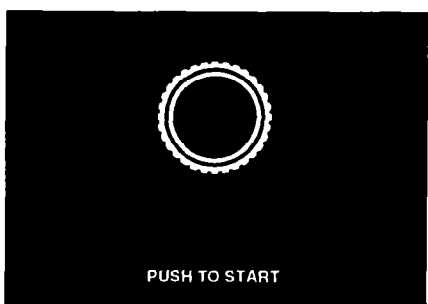

3. **Push the Start Button** to start the dryer.

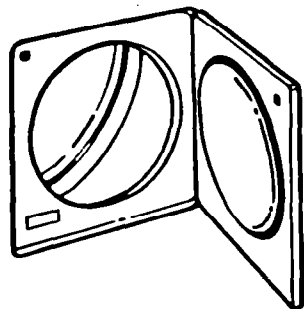

To stop and restart the dryer

- Open the door or turn the Cycle Control Knob to OFF to stop the dryer.
- Close the door, select a cycle (if necessary) and push the Start Button to restart the dryer.

The Cycle Control Knob should point to an OFF area when the dryer is not in use. If the dryer is stopped before the cycle is finished, turn the Cycle Control Knob to an OFF area.

The automatic cycles

The automatic cycles allow you to select the degree of dryness you prefer for the clothes being dried.

The automatic DRY-MISER® control is a thermostat that senses the dryer air temperature. The dryer automatically shuts off when the selected dryness is reached.

The Cycle Control Knob will not move until the load is almost dry or the cool-down portion of the cycle has been reached. After the cool-down portion is complete, the Cycle Control Knob automatically moves to an OFF area and tumbling stops.

Use **AUTOMATIC REGULAR** to dry heavy or mediumweight items. The load tumbles without heat during the last 5 minutes. This helps make the load easier to handle.

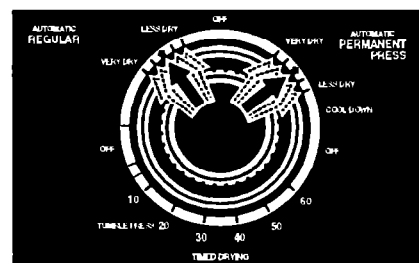
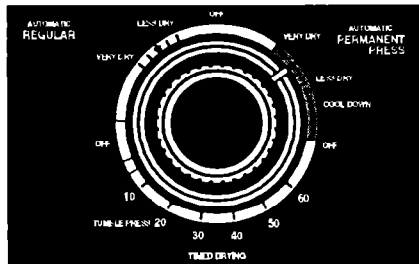
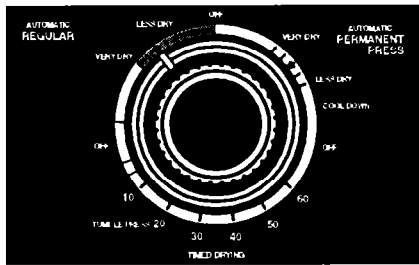

Use **AUTOMATIC PERMANENT PRESS** to dry permanent press, knits and other synthetic items. The load tumbles without heat during the last 10 minutes. This helps keep wrinkles from setting in and makes the load easier to handle.

For the first few loads, set the Cycle Control Knob to point to the ★ in either automatic cycle. When the dryer stops, feel the dried items.

- If items are drier than you like, use a setting to the right of the ★ the next time you dry a similar load.
- If items are not as dry as you like, use a setting to the left of the ★ the next time you dry a similar load.

NOTE: Overdrying can cause shrinkage, static cling and damage to some fabrics.

Operating Instructions Continued

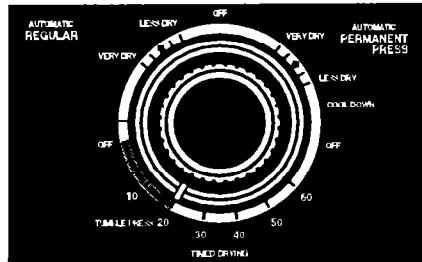
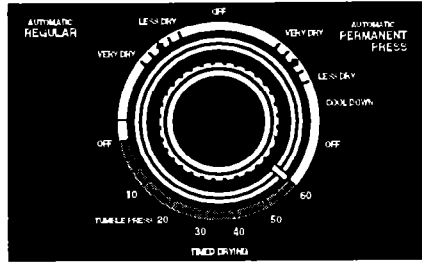

TIMED DRYING

Use the **TIMED DRYING** cycle for any load you want to dry by time. This cycle is designed for small loads, large bulky items or items to be fluffed or dusted using the Fluff Air temperature setting.

- Turn the Cycle Control Knob to the number of minutes you want from 10 to 60.
- For a damp dry, turn the Cycle Control Knob to 30 minutes or less.

The last 5 minutes of this cycle are without heat to help make the load easier to handle.

Using TUMBLE PRESS®

The **TUMBLE PRESS** setting removes wrinkles from clothing that has been packed in a suitcase or closet, and from items not removed from the dryer at the end of a cycle.

1. Set the Cycle Control Knob on **TUMBLE PRESS** in the **TIMED DRYING** cycle.
2. Set the Temperature Selector on **PERM'T PRESS HEAVY HIGH**.
3. Push the Start Button.

The load will tumble in heated air for 15 minutes. Then the dryer will tumble the clothes for 5 more minutes without heat.

For best results, put only a few items at a time in this cycle. As soon as the dryer stops, put the items on hangers or fold them.

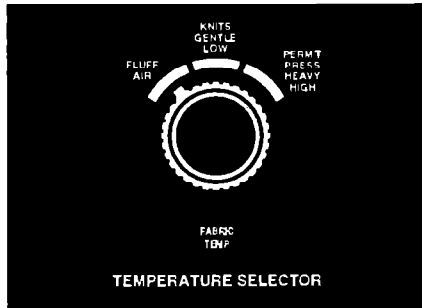

Using FLUFF AIR

⚠ WARNING

Fire Hazard

Do not dry plastic or rubber items with heat. Use FLUFF AIR setting, or line dry.

Failure to do so could result in fire or damaged items.

The dryer does not heat when the Temperature Selector is set to FLUFF AIR. This can be used to fluff or air dry bedding, plastic tablecloths, foam rubber pillows, stuffed toys, sneakers, etc.

1. Turn the Temperature Selector to FLUFF AIR.
2. Turn the Cycle Control Knob to the number of minutes you want in the TIMED DRYING cycle.
3. Push the Start Button.

NOTE: Repeat steps above if more time is needed to dry items.

Caring For Your Dryer

CAUTION

Product and Fabric Damage Hazard
Do not run the dryer with the lint screen loose, damaged, blocked or missing. Doing so can cause overheating and damage to both the dryer and fabrics.

Cleaning the lint screen

The lint screen is conveniently located on top of the dryer. **Clean it before each load.** A screen blocked by lint can increase drying time.

1. Pull the lint screen straight out.

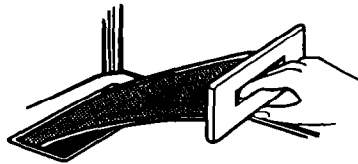

2. Roll lint off the screen with your fingers. Do not rinse or wash the screen to remove lint. Wet lint is hard to remove.

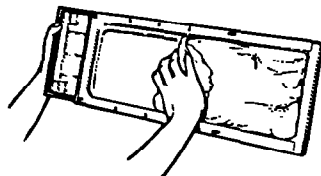

3. Push the lint screen firmly back into place.

Lint screen maintenance

Laundry detergents and fabric softeners can cause a residue build-up on the lint screen. A clogged lint screen can extend drying times. Clean the lint screen every six months or more frequently if it becomes clogged due to a residue build-up. Use the following method:

1. Wet both sides of lint screen with hot water.

2. Wet a nylon brush with hot water and liquid detergent.

3. Scrub lint screen with the brush until all residue build-up is removed.

4. Rinse with hot water.

5. **Thoroughly** dry lint screen with a clean towel and replace in dryer.

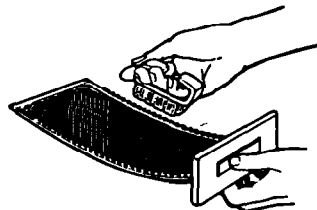

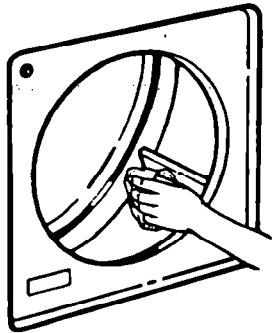

Cleaning the dryer

⚠ WARNING

Electrical Shock and Personal Injury Hazard

- Turn off the electrical power before cleaning the interior.
 - Make sure the dryer is cool.
- Failure to do so could result in electrical shock or injury.

Fire Hazard

- Use non-flammable cleaner.
- Failure to do so could result in an explosion.

Garments which contain unstable dyes, such as denim blue jeans or brightly colored cotton items, may discolor the dryer interior.

If you want to remove stains from dryer drum use one of the following methods:

Powdered laundry detergent

1. Make a paste with detergent and very warm water.
2. Apply paste to a soft cloth and scrub area until all excess dye is removed.
3. Wipe thoroughly with a damp cloth.
4. Tumble a load of rags to dry.

Liquid non-flammable household cleaner

1. Apply to stained area.
2. Rub with a cloth until all excess dye is removed.
3. Wipe thoroughly with a damp cloth.
4. Tumble a load of rags to dry.

To clean dryer exterior:

Wipe with a soft, damp cloth.

Caring For Your Dryer
Continued

Lint removal

Lint can gather inside the dryer and be a fuel for fire. It is recommended the lint be removed every 2 to 3 years, or more often, depending on dryer usage. Cleaning should be done by a qualified person. If you have any questions, please call our Consumer Assistance Center at 1-800-253-1301.

⚠ WARNING

Electrical Shock and Personal Injury Hazard

- Unplug the power supply cord or turn off the electrical power before removing dryer panels.
- Make sure the dryer is cool.
- Dryer parts can have sharp edges. Use care when handling.
- When replacing front panel after lint removal, the wire clips holding the door switch wires must be anchored to top of front and side panels. Wires **MUST NOT** touch rotating drum. (See page 13, step 7.) Failure to do so could result in electrical shock or personal injury.

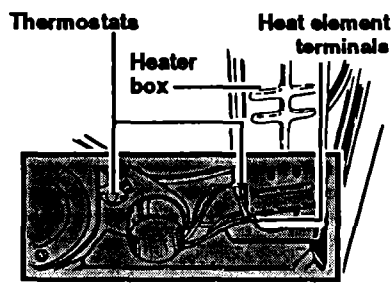

Electric dryer with back panel removed

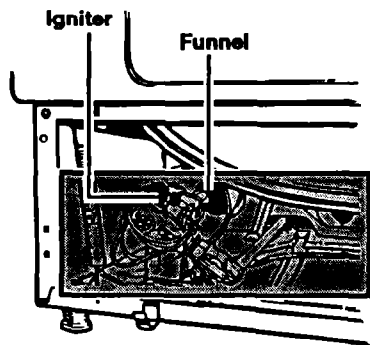

Gas dryer with lower front access panel removed

If your dryer is electric, or is gas and has a lower front access panel:

1. Unplug the power supply cord or turn off the electrical power.
2. Remove back panel (electric) or lower front access panel (gas). See Installation Instructions.
3. Remove lint from shaded area in illustration with a soft brush or vacuum cleaner. Avoid damaging wires, thermostats (electric), funnel (gas) or igniter (gas).
4. Replace panel; reconnect and level dryer again, if necessary.

NOTE: See page 13 if your dryer is gas and has a full front panel.

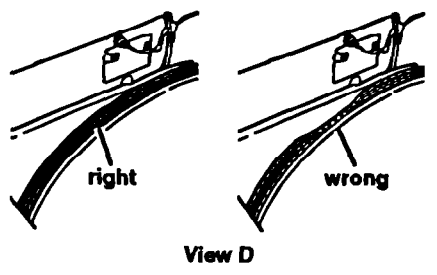
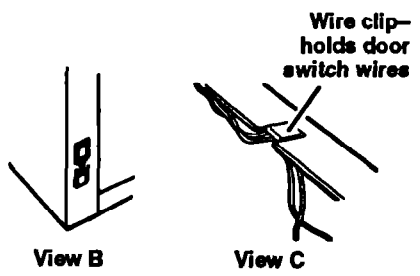
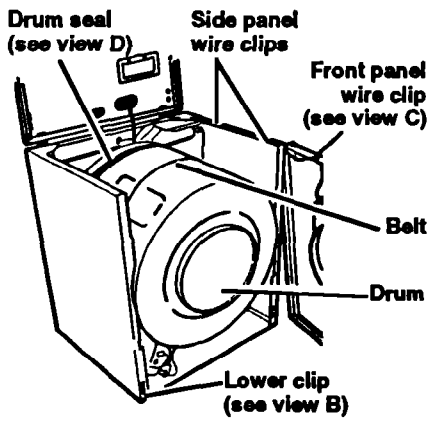
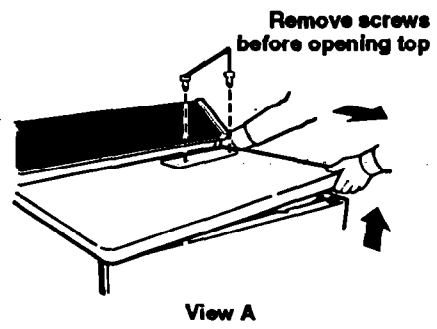

If your dryer is gas and has a full front panel, remove front panel as follows:

1. Unplug the power supply cord or turn off the electrical power.
2. Remove lint screen. Remove two screws in lint screen area.
3. Open top by pulling forward and up at each front corner (see view A). Rest raised top against wall behind dryer (top is hinged at rear).
4. Remove two internal screws from front panel flanges (near top front corners). Lift front panel slightly, lifting off lower clips (see view B). Slowly pull front panel forward, disengaging panel from drum. (Drum will drop slightly.)
5. Move front panel aside and rest edge against side of dryer. Avoid disconnecting wire clips (see view C) or damaging wires.
6. Remove lint from area shown in "gas dryer" illustration on page 12 with soft brush or vacuum cleaner. Avoid damaging wires, funnel or igniter.
7. Reassemble in reverse order. Before closing the top, check the following:
 - Drum seal must be flared out (see view D) and properly positioned against panel at back of drum. Rotate drum counterclockwise one full turn to check drum seal.
 - Belt should be centered and tight on dryer drum.
 - Wire clips which hold the door switch wires must be anchored in slot in top of front panel (see view C) and along top edge of side panel. Door wires must not touch drum when dryer is operating. See Warning, page 12.
8. Replace top panel and lint screen screws. Top and front panels must be securely in place before operating dryer.
9. Reconnect power and level dryer again (if necessary).

NOTE: Call Consumer Assistance at 1-800-253-1301 for assistance or more information.

If You Need Service Or Assistance

We suggest you follow these steps:

1. Before calling for assistance ...

Performance problems often result from little things you can find and fix yourself without tools of any kind.

If your dryer does not run:

- Is the power supply plugged into a live circuit with the proper voltage?
- Is the door closed tightly?
- Did you push the Start Button?
- Have you checked your home's main fuses or circuit breaker box?

If your dryer does not heat:

- The FLUFF AIR setting is without heat.
- The last minutes of heat settings are without heat.
- If you have a gas dryer, is the gas turned on? If not, turn the Cycle Control Knob to OFF. Turn on gas. Wait 5 minutes. Reset controls and start.
- The circuit supplying an electric dryer uses 2 breakers or 2 fuses. If one breaker is tripped or one fuse is blown, the dryer may run, but not heat.

If drying time seems too long:

- Is the lint screen clean? See page 10 for cleaning instructions.
- Is the exhaust duct or outside exhaust hood clogged? Clean if needed.
- See the Dryer Guide.

2. If you need assistance*...

Call Whirlpool Consumer Assistance Center telephone number. Dial free from anywhere in the U.S.:

1-800-253-1301

and talk with one of our trained consultants. The consultant can instruct you in how to obtain satisfactory operation from your appliance or, if service is necessary, recommend a qualified service company in your area.

If you prefer, write to:

Mr. William Clark
Consumer Assistance Representative
Whirlpool Corporation
2000 M-63
Benton Harbor, MI 49022

Please include a daytime phone number in your correspondence.

3. If you need service*...



Whirlpool has a nationwide network of authorized WhirlpoolSM service companies.

Whirlpool service technicians are trained to fulfill the product warranty and provide after-warranty service, anywhere in the United States. To locate the authorized Whirlpool service company in your area, call our Consumer Assistance Center telephone number (see Step 2) or look in your telephone directory Yellow Pages under:

APPLIANCES - HOUSEHOLD - ELECTRICAL APPLIANCES -
MAJOR - SERVICE & REPAIR MAJOR - REPAIRING & PARTS

OR

WASHING MACHINES, DRYERS
& IRONERS - SERVICING

WHIRLPOOL APPLIANCES
AUTHORIZED WHIRLPOOL SERVICE

SERVICE COMPANIES
XYZ SERVICE CO
123 Maple _____ 000-0000

**If You Need Service Or Assistance
Continued**

**4. If you need FSP®
replacement parts*...**

FSP is a registered trademark of Whirlpool Corporation for quality parts. Look for this symbol of quality whenever you need a replacement part for your Whirlpool appliance. FSP replacement parts will fit right and work right, because they are made to the same exacting specifications used to build every new Whirlpool appliance.

To locate FSP replacement parts in your area, refer to Step 3 or call the Whirlpool Consumer Assistance Center number in Step 2.

**5. If you are not satisfied with how
the problem was solved*...**

- Contact the Major Appliance Consumer Action Panel (MACAP). MACAP is a group of independent consumer experts that voices consumer views at the highest levels of the major appliance industry.
- Contact MACAP only when the dealer, authorized servicer and Whirlpool have failed to resolve your problem.

Major Appliance Consumer
Action Panel
20 North Wacker Drive
Chicago, IL 60606

- MACAP will in turn inform us of your action.

*When requesting assistance, please provide: model number, serial number, date of purchase, and a complete description of the problem. This information is needed in order to better respond to your request.

IF YOU NEED SERVICE OR ASSISTANCE

WHIRLPOOL®

Automatic Dryer Warranty

DR006

LENGTH OF WARRANTY	WHIRLPOOL WILL PAY FOR
FULL ONE-YEAR WARRANTY From Date of Purchase	FSP® replacement parts and repair labor to correct defects in materials or workmanship. Service must be provided by an authorized Whirlpool SM service company.
WHIRLPOOL WILL NOT PAY FOR	
<p>A. Service calls to:</p> <ol style="list-style-type: none"> 1. Correct the installation of the dryer. 2. Instruct you how to use the dryer. 3. Replace house fuses or correct house wiring or plumbing. 4. Replace light bulbs. <p>B. Repairs when dryer is used in other than normal, single-family household use.</p> <p>C. Pickup and delivery. This product is designed to be repaired in the home.</p> <p>D. Damage to dryer caused by accident, misuse, fire, flood, acts of God or use of products not approved by Whirlpool.</p> <p>E. Repairs to parts or systems caused by unauthorized modifications made to the appliance.</p>	

WHIRLPOOL CORPORATION SHALL NOT BE LIABLE FOR INCIDENTAL OR CONSEQUENTIAL DAMAGES. Some states do not allow the exclusion or limitation of incidental or consequential damages so this limitation or exclusion may not apply to you. This warranty gives you specific legal rights, and you may also have other rights which vary from state to state.

Outside the United States, a different warranty may apply. For details, please contact your authorized Whirlpool distributor or military exchange.

If you need service, first see the "Service and Assistance" section of this book. After checking "Service and Assistance," additional help can be found by calling our Consumer Assistance Center telephone number, 1-800-253-1301, from anywhere in the U.S.

® Registered Trademark/SM Service Mark of Whirlpool Corporation