

SAFETY INSTRUCTIONS

WARNING: If the information in this manual is not followed exactly, a fire or explosion may result causing property damage, personal injury or death.

- Do not store or use gasoline or other flammable vapors and liquids in the vicinity of this or any other appliance.
- **WHAT TO DO IF YOU SMELL GAS**
 - Do not try to light any appliance.
 - Do not touch any electrical switch; do not use any phone in your building.
 - Immediately call your gas supplier from a neighbor's phone. Follow the gas supplier's instructions.
 - If you cannot reach your gas supplier, call the fire department.
- Installation and service must be performed by a qualified installer, service agency or the gas supplier.

GENERAL

No cooking appliance should be used as a space heater. This instruction is based on safety considerations to prevent potential hazard to the consumer as well as damage to the appliance.

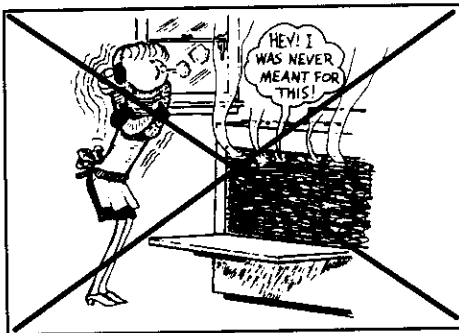

If range is installed near a window, proper precautions should be taken to prevent curtains from blowing over burners creating a FIRE HAZARD.

Keep area around appliance clear and free from combustible materials, gaso-

line, and other flammable vapors and materials.

Have the installer show you the location of the gas shut off valve and how to shut it off in an emergency.

Your appliance is vented through the base of the backguard. Never block oven vent or air intakes. Do not obstruct the flow of combustion and ventilation air. Restriction of air flow to the burner prevents proper performance.

Avoid touching oven vent area while oven is on and for several minutes after oven is turned off. Some parts of the vent and surrounding area become hot enough to cause burns.

Do not use cooktop or oven as a storage area for food or cooking utensils. This instruction is based on safety considerations to prevent potential hazard to user and to the appliance.

Misuse of appliance doors, such as stepping, leaning or sitting on the door, may result in possible tipping of the appliance or breakage of door and serious injuries.

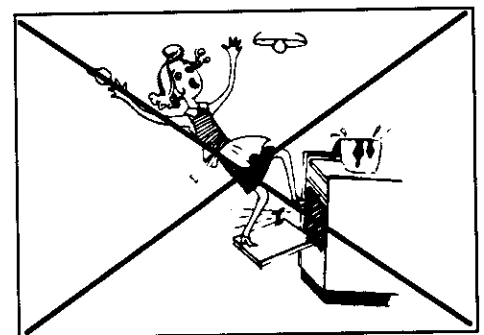

IN CASE OF FIRE:

1. Turn off range controls.
2. Smother fire or flame with baking soda, dry chemical, or a foam-type extinguisher. Do not use water on grease fires.

SAFETY INSTRUCTIONS

CHILD SAFETY

Do not leave children alone or unsupervised near the appliance when it is in use or is still hot. Children should never be allowed to sit or stand on any part of the appliance. Children must be taught that the appliance and utensils in it can be hot. Children should be taught that an appliance is not a toy. They should not be allowed to play with controls or other parts of the unit. Let hot utensils cool in a safe place, out of reach of small children.

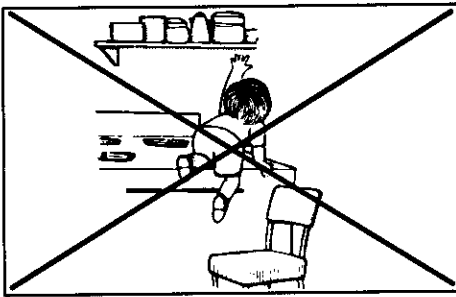

CAUTION: Do not store items of interest to children in cabinets above an appliance or on the backguard of a range. Children climbing on the appliance to reach items could be seriously injured. Do not use an appliance as a step stool to cabinets above.

ANTI-TIP DEVICE

To reduce the risk of tipping of the appliance from unusual usage or by excessive loading of the oven door, the appliance must be secured by a properly installed anti-tip device. To check if device is installed properly: Use a flashlight and look underneath range to see that one of the rear leveling legs is engaged in the bracket slot. When removing appliance for cleaning, be sure anti-tip device is engaged when range is replaced. The anti-tip device secures the rear leveling leg to the floor, when properly engaged.

CLEANING

Turn off all controls and wait for range parts to cool before touching or cleaning them. Do not touch the burner grates or surrounding areas until they have had sufficient time to cool.

Touching a hot oven light bulb with a damp cloth could cause the bulb to break. Should the bulb break, disconnect power to the range before trying to remove the bulb to avoid electrical shock.

Clean range with caution. If a wet sponge or cloth is used to wipe spills on a hot cooking area, be careful to avoid steam burns. Some cleaners can produce noxious fumes if applied to a hot surface.

GREASE

Use extreme caution when moving the grease kettle or disposing of hot grease.

Hot grease is flammable. Avoid letting grease deposits collect around appliance, range hood, or vent fan. Do not leave container of grease around a cooking appliance. Always let quantities of hot fat used for deep fat frying cool before attempting to move or handle. In the event of a grease fire, DO NOT attempt to move pan. Cover pan with a lid to extinguish flame and turn surface burner off. Do not douse flame with water. Use a dry chemical or foam-type fire extinguisher, if available, or sprinkle heavily with baking soda.

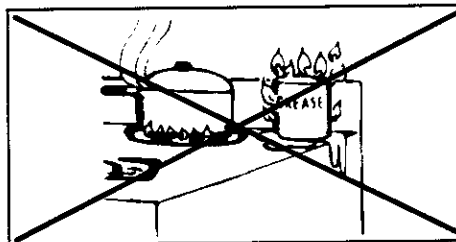

Spills or boilovers which contain grease should be cleaned up as soon as possible. If they are allowed to accumulate, they could create a FIRE HAZARD.

COOKING SAFETY

Always adjust surface burners flame so that it does not extend beyond the bottom of utensil. This instruction is based on safety considerations.

Never leave a surface cooking operation unattended especially when using a high heat setting. Boilovers cause smoking and greasy spillovers may ignite.

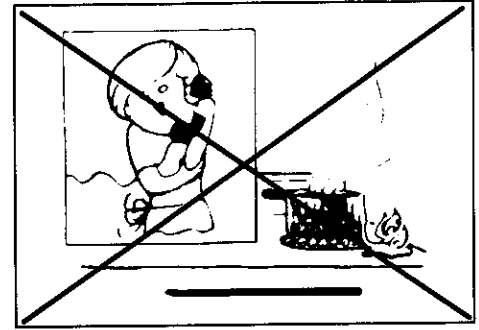

Be sure you know which knob controls which surface burner. Always make sure the correct burner is turned on and that the burner has ignited. When cooking is completed, turn burner off.

Use caution when wearing garments made of flammable material to avoid clothing fires. Loose fitting or long hanging-sleeved apparel should not be worn while cooking. Clothing may ignite or catch utensil handles.

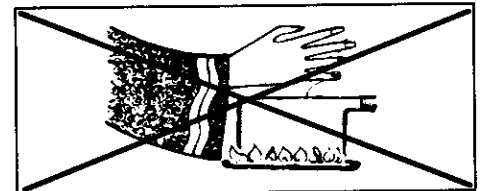

Never heat an unopened container on the surface burner or in the oven. Pressure build-up may cause container to burst resulting in serious personal injury or damage to the range.

Slide oven rack out to add or remove food, using dry, sturdy pot holders. Always avoid reaching into oven to place or remove food.

Use dry, sturdy pot holders. Damp pot holders may cause burns from steam. Dish towels or other substitutes should never be used as pot holders because they can trail across hot surface burners and ignite or get caught on range parts.

Use care when opening oven door. Let hot air or steam escape before removing or replacing food. Always place oven racks in the desired positions while oven is cool. If a rack must be moved while hot, be careful to avoid contact of pot holders with oven burner flame.

SAFETY INSTRUCTIONS

STORAGE ABOVE RANGE

To eliminate the hazard of reaching over hot surface burners, cabinet storage should not be provided directly above a unit. If such storage is provided, it should be limited to items which are used infrequently and which are safely stored in an area subjected to heat from an appliance. Temperatures in storage areas above the unit may be unsafe for some items, such as volatile liquids, cleaners or aerosol sprays.

UTENSIL SAFETY

Use only pans that have flat bottoms and handles that are easily grasped and stay cool. Avoid using unstable, warped, easily tipped or loose handled pans. Do not use pans if their handles twist and cannot be tightened. Pans that are heavy to move when filled with food may also be hazardous.

Always place a pan of food on a surface burner before turning it on, and turn it off before removing the pan.

Always turn pan handles to the side or back of appliance, not out into the room where they are easily hit or reached by small children. To minimize burns, ignition of flammable materials and spillage due to unintentional contact with the utensil, do not extend handles over adjacent surface burners.

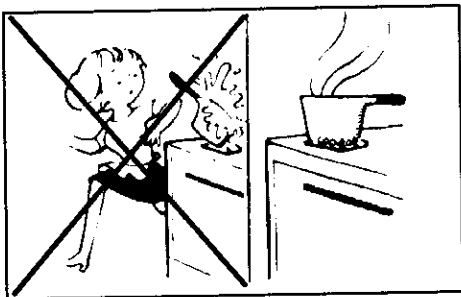

Be sure utensil is large enough to properly contain food and avoid boilovers. Pan size is particularly important in deep fat frying. Be sure pan will accommodate the volume of food that is to be added as well as the bubble action of fat. Never leave a deep fat frying operation unattended.

Never let a pan boil dry as this could damage the utensil and the appliance.

ALUMINUM FOIL

Use aluminum foil ONLY as instructed in this book. Improper use of aluminum foil may cause damage to the oven, affect cooking results, and can also result in shock and/or fire hazards.

PLASTICS

Many plastics are vulnerable to heat. Keep plastics away from parts of the appliance that may become warm or hot.

AEROSOL SPRAYS

Many aerosol-type spray cans are EXPLOSIVE when exposed to heat and may be highly flammable. Avoid their use or storage near an appliance.

SELF-CLEAN OVEN

Do not clean door gasket. The door gasket is essential for a good seal. Care should be taken not to rub, damage, or move the gasket. Do not use oven cleaners of any kind in or around any part of the self-clean oven. Clean only parts listed in this booklet. Before self-cleaning the oven, remove broiler pan, oven racks, and other utensils, and wipe off excessive spillovers.

It is normal for the cooktop of the range to become hot during a self-clean cycle. Therefore, touching or lifting the cooktop during a clean cycle should be avoided.

IMPORTANT SAFETY NOTICE AND WARNING

The California Safe Drinking Water and Toxic Enforcement Act of 1986 (Proposition 65) requires the Governor of California to publish a list of substances known to the State of California to cause cancer or reproductive harm, and requires businesses to warn customers of potential exposures to such substances.

Users of this appliance are hereby warned that the burning of gas can result in low-level exposure to some of the listed substances, including benzene, formaldehyde and soot, due primarily to the incomplete combustion of natural gas or liquid petroleum (LP) fuels. Properly adjusted burners will minimize incomplete combustion. Exposure to these substances can also be minimized by properly venting the burners to the outdoors.

VENTILATING HOOD

To reduce the hazard of storage above a range, install a ventilating hood that projects at least 5 inches beyond the bottom edge of the cabinets. Clean hood frequently to prevent grease from accumulating on hood or its filter. Should a boilover or spillover result in an open flame, immediately turn off the hood's fan to avoid spreading the flame. After thoroughly extinguishing flame, the fan may be turned on to remove unpleasant odor or smoke.

FEATURES

ANALOG CLOCK AND TIMER, if equipped

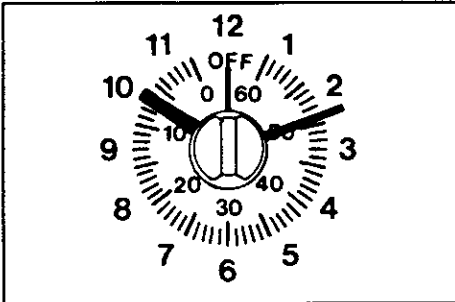

TO SET CLOCK: Push in and turn Minute Minder knob to the correct time-of-day. Be sure Minute Minder hand is on OFF after setting clock.

TO SET MINUTE MINDER: Turn knob in either direction to the desired time. When the buzzer sounds, manually turn the Minder to OFF.

DIGITAL CLOCK AND TIMER, if equipped



88:88 will flash in the display when oven is first connected to power or if power is interrupted.

TO SET CLOCK: Press and hold CLOCK SET button while turning MINUTE TIMER knob to the correct time-of-day. MINUTE TIMER knob can be turned in either direction.

TO SET MINUTE TIMER: Turn MINUTE TIMER knob to the right, to the desired time, up to 60:00 (1 hour). Timer will begin counting down after a few seconds delay. When time has lapsed, a continual beep will sound for up to 2 minutes.

TO STOP BEEPS: Press CLOCK SET button to stop beep sounds. The correct time-of-day will reappear in the display.

TO CANCEL A TIMING OPERATION: Turn MINUTE TIMER knob to the left, until 00:00 appears in the display. The correct time-of-day will reappear in the display after a few seconds delay.

TO CHECK TIME-OF-DAY DURING A TIMING OPERATION: Press and hold CLOCK SET button. Time will reappear in the display.

FEATURES

CONTINUOUS CLEANING OVEN (if equipped)

WHAT IS THE CONTINUOUS CLEANING OVEN?

The finish of the Continuous Cleaning Oven is identified by its dark gray color, and rough, porous texture. The rough texture prevents grease spatters from forming beads which run down the walls leaving unsightly streaks. Rather, the rough texture absorbs spatters and allows them to spread, thus exposing a larger area to the hot oven air. The catalyst, when exposed to heat, speeds the oxidation of soil.

Cleaning action automatically begins whenever the oven is turned on for baking or roasting. The oven **MUST** be "on" for cleaning to take place. No cleaning will occur when the oven is off. The special catalytic finish must be exposed to hot oven air before soil will begin to gradually reduce in size.

FACTORS AFFECTING LENGTH OF CLEANING TIME

The higher the oven temperature, the faster the cleaning action. The length of cleaning time will depend on these factors: Type of soil, amount or size of soil, oven temperature and length of time oven is in use. Time may vary from a few minutes to several hours. Soil deposited at the end of a cycle may still be visible. This will usually fade with continued oven use until the soil gradually disappears or can be wiped up manually. The oven will appear presentably clean, even though some spatters may be present.

MANUALLY CLEANING HEAVY SPILLOVERS

The special finish will clean most spatters during normal oven use unless there is a heavy buildup of soil. Heavy spillovers such as pie or casserole boilovers will not clean effectively without some manual help. The crusty or varnish-like stains that form from these spillovers clog the pores and prevent the special finish from being exposed to the hot oven air. This greatly reduces the cleaning effectiveness of the finish.

These crusty or varnish-like stains must either be removed or broken up before cleaning can effectively take place.

TO MANUALLY CLEAN HEAVY SPILLOVERS

Brush off heavy soil with a nylon brush or plastic pad. **DO NOT USE** paper towels, cloths or sponges for the oven walls are porous and particles of these materials will rub off on the walls. Rinse area with clear water only.

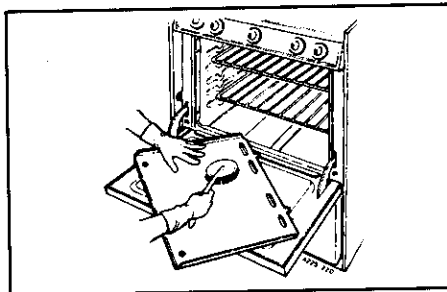

HINTS

Brittle crusts or stains can be loosened by **GENTLY** tapping stain with a wooden or plastic utensil. Brush away any loose soil that flakes off. Varnish type stains usually need to be softened with a small amount of water or damp cloth. Remaining soil will gradually reduce with continued oven use at normal baking temperatures.

DO NOT USE ANY TYPE OF OVEN CLEANER, POWDERED CLEANSERS, SOAP, DETERGENT OR PASTE ON ANY CONTINUOUS CLEANING SURFACE. ALSO, DO NOT USE ANY ABRASIVE MATERIALS, STEEL WOOL, SHARP INSTRUMENTS OR SCRAPERS FOR THEY WILL DAMAGE THE FINISH.

Avoid spillovers by using utensils that are large enough to hold food. A cookie sheet or piece of aluminum foil, just a little larger than the pan, can be placed on the rack directly below the rack holding the utensil to catch spills.

Over a period of time, wear marks may appear on the embossed rack supports. This is normal and results from sliding the racks in and out of the oven. Wear marks will not affect the cleaning action of the oven.

USING YOUR OVEN

PILOT IGNITION

Be sure oven control is set in the OFF position prior to supplying gas to the appliance.

To light oven pilot: When cool, remove oven racks and oven bottom. With the oven thermostat knob in the OFF position, hold a lighted match to the pilot located at the back end of the oven burner. Once pilot lights, replace oven bottom and racks.

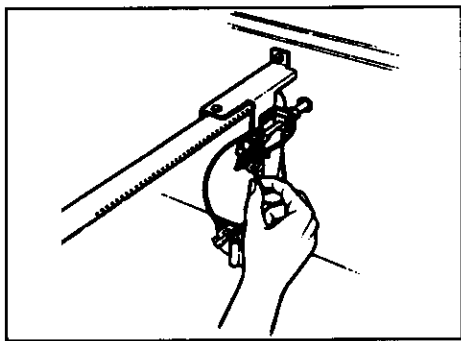

PILOTLESS IGNITION

Glo bar-type ignition

With this type of ignition system, the oven will not operate during a power failure or if unit is disconnected from the wall outlet. No attempt should be made to operate oven during a power failure.

OVEN BURNER

The size and appearance of a properly adjusted oven burner flame should be as shown:

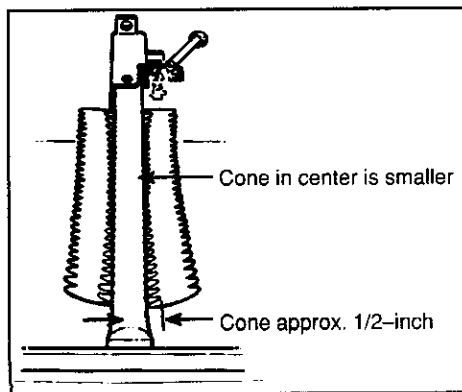

OVEN DOOR

When opening oven door, allow steam and hot air to escape before reaching in oven to check, add or remove food.

Do not attempt to open or close door until door is completely seated on hinge arms. Never turn on oven unless door is properly in place. When baking, be sure door is completely closed. Baking results will be affected if door is not securely closed.

Your wall oven will feature either the standard door (Design 1) or a door with special hinges (Design 2).

DESIGN 1 – STANDARD DOOR

To remove door: Open door to the "stop" position (opened about 4 inches) and grasp door with both hands at each side. Do not use door handle to lift door. Lift up evenly until door clears the hinge arms.

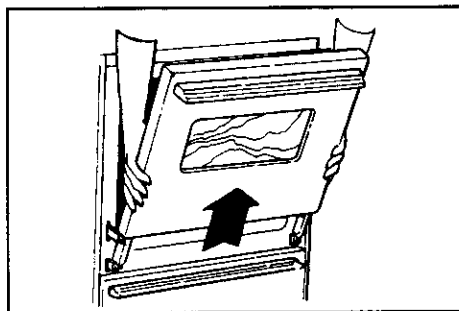

CAUTION:

Hinge arms are spring mounted and will slam shut against the oven if accidentally hit. **Never place hand or fingers between the hinges and the front oven frame.** You could be injured if hinge snaps back.

To replace door: Grasp door at each side, align slots in the door with the hinge arms and slide door down onto the hinge arms until completely seated on hinges.

DESIGN 2 – SPECIAL DOOR

On some models, the oven door is equipped with a special hinge that locks into place as the door is removed.

To remove door with special hinges:

1. Open door to the broil stop position (open about 4 inches).
2. Grasp the sides of the door at the middle of the door. **Slowly** lift door straight up.
3. As you lift the door up, **very slightly** open door by pulling door toward you. Check to be sure latches (A) swing down into the notches on the hinge arms.

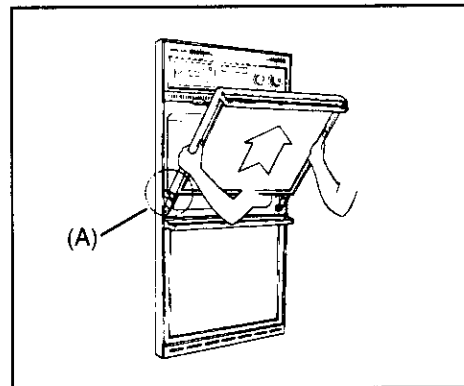

To replace door:

1. Grasp sides of door and align slots in door with hinge arms.
2. **Very slightly** pull door to a more open position as you slide the door down onto the hinge arms. The sliding action of the door will disengage the latches on the hinge arms.
3. Gently push the door downward until the door rests evenly on the hinges. Close door.

USING YOUR OVEN

OVEN BOTTOM

Your oven will be equipped with one of the following types of oven bottoms. Be sure oven bottom is cool. Remove oven racks.

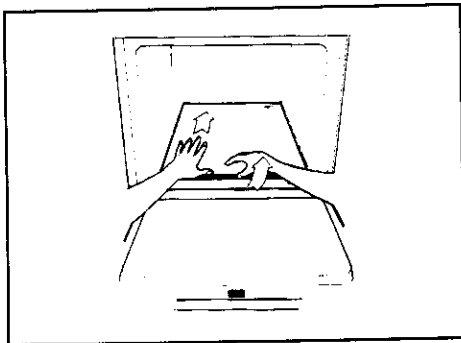

To remove: Push oven bottom to the rear of oven and lift up at the front. When replacing, be sure holes in bottom front flange are positioned on these two front screws.

OR

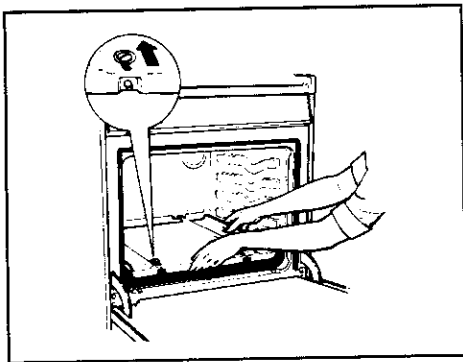

To remove: Loosen the two screws located along the front of the oven bottom. Slide the screws back to release the front of the oven bottom. Grasp oven bottom, lift up and pull forward until rear tabs release. Then, remove oven bottom from oven.

To replace: Insert tabs into slots on the back oven wall. Lower into place. Slide two screws forward and tighten. Be sure bottom is fitted into slots and screws are tight. If not correctly replaced, oven bottom may become warped and cooking results will be affected.

OVEN RACKS

The two oven racks are designed with a "lock-stop" position to keep racks from accidentally coming completely out of the oven.

To remove: Be sure rack is cool. Pull rack out to the "lock-stop" position. Tilt up and continue pulling until rack releases.

To replace: Place rack on rack supports, tilt up and push toward rear of oven. Pull rack out to "lock-stop" position to be sure rack is correctly replaced.

RACK POSITIONS:

RACK 1 (top of oven) used for two-rack cooking.

RACK 2 used for one-rack baking or broiling.

RACK 3 used for most one-rack baking and for roasting some meats.

RACK 4 used for roasting large meats, cooking larger foods and for baking angel food cake or pie shells.

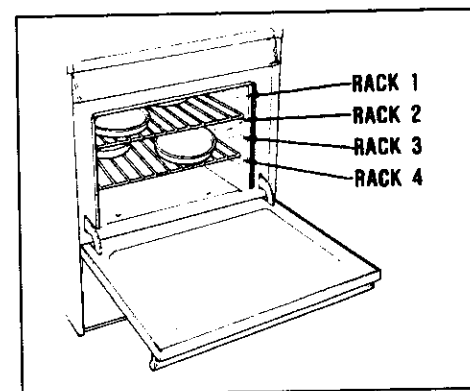

USING YOUR OVEN

THERMOSTAT KNOB

The THERMOSTAT knob is used to select and maintain the oven temperature. Always turn this knob just TO the desired temperature not to a higher temperature and then back. On some models, there is an indent at the 350°F setting. Turn this knob to OFF whenever the oven is not in use.

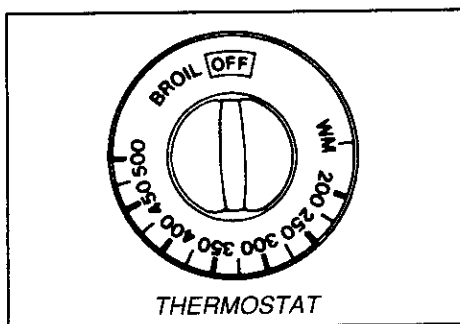

Pilotless Ignition Models:

Oven cannot be used during a power failure.

PREHEATING

Preheating is necessary for baking. Allow oven to heat for 10 to 15 minutes before adding food. It is not necessary to preheat oven for roasting.

It is not necessary to preheat for broiling unless darker browning is desired or if

cooking thin (3/4-inch) steaks. Allow burner to preheat 3 to 5 minutes.

Selecting temperature higher than desired will NOT preheat the oven any faster. Preheating at a higher temperature may have a negative effect on baking results.

The oven temperature is maintained by cycling the burner on and off. After the oven temperature has been set, there will be about a 45 second delay before the burner ignites. This is normal, and no gas escapes during this delay.

HINTS:

For optimum baking results of cakes, cookies, or biscuits, or if using a cookie sheet, use one rack. Position rack so food is in the center of the oven. Allow 2 inches between edge of utensil and the oven sides or adjacent utensils.

NEVER place pans directly on the oven bottom. Do not cover entire rack with aluminum foil. Do not place foil directly on oven bottom or place foil directly under utensil. To catch spillovers, cut a piece of foil a little larger than the pan and place it on the rack below the rack containing the utensil.

If cooking on two racks, stagger pans so one is not directly over the other. Use rack positions 2 and 4, or 1 and 3, depending on baking results, when cooking on two racks.

OVEN CHARACTERISTICS

Every oven has its own characteristics. You may find that the cooking times and temperatures you were accustomed to with your previous oven may need to be altered slightly with your new oven. Please expect some differences with this new oven.

HOW TO SET OVEN:

1. Place rack in correct position.
2. Turn thermostat knob to desired temperature setting for baking or roasting. Turn to BROIL for a broil operation.
3. Preheat oven for baking operations or if called for in the recipe.
4. Check food for doneness at minimum time in recipe. Cook longer if necessary.
5. Turn thermostat knob to OFF and remove food from the oven.

USING YOUR OVEN

COMMON BAKING PROBLEMS AND WHY THEY HAPPEN

PROBLEM	CAUSE	PROBLEM	CAUSE
<i>Cakes are uneven.</i>	Pans touching each other or oven walls. Batter uneven in pans. Temperature set too low or baking time too short. Oven not level. Undermixing. Too much liquid.	<i>Cakes don't brown on top.</i>	Incorrect rack position. Temperature set too low. Overmixing. Too much liquid. Pan size too large or too little batter in pan. Oven door opened too often.
<i>Cake high in middle.</i>	Temperature set too high. Baking time too long. Overmixing. Too much flour. Pans touching each other or oven walls. Incorrect rack position.	<i>Excessive shrinkage.</i>	Too little leavening. Overmixing. Pan too large. Temperature set too high. Baking time too long. Pans too close to each other or oven walls.
<i>Cake falls.</i>	Too much shortening or sugar. Too much or too little liquid. Temperature set too low. Old or too little baking powder. Pan too small. Oven door opened frequently. Added incorrect type of oil to cake mix. Added additional ingredients to cake mix or recipe.	<i>Uneven texture.</i>	Too much liquid. Undermixing. Temperature set too low. Baking time too short.
<i>Cakes, cookies, biscuits don't brown evenly.</i>	Incorrect rack position. Oven door not closed properly. Door gasket not sealing properly. Incorrect use of aluminum foil. Oven not preheated. Pans darkened, dented or warped.	<i>Cakes have tunnels.</i>	Not enough shortening. Too much baking powder. Overmixing or at too high a speed. Temperature set too high.
<p>For optimum results, bake on one rack. If baking cakes on two racks, stagger pans so one is not directly over another.</p>		<i>Cakes crack on top.</i>	Batter overmixed. Temperature set too high. Too much leavening. Incorrect rack position.
		<i>Cake not done in middle.</i>	Temperature set too high. Pan too small. Baking time too short.
		<p>If additional ingredients were added to mix or recipe, expect cooking time to increase.</p>	
<i>Cakes, cookies, biscuits too brown on bottom.</i>	Oven not preheated. Pans touching each other or oven walls. Incorrect rack position. Incorrect use of aluminum foil. Placed 2 cookie sheets on one rack. Used glass, darkened, stained, warped or dull finish metal pans. (Use a shiny cookie sheet.)	<i>Pie crust edges too brown.</i>	Temperature set too high. Pans touching each other or oven walls. Edges of crust too thin.
		<i>Pies don't brown on bottom.</i>	Used shiny metal pans. Temperature set too low.
		<i>Pies have soaked crust.</i>	Temperature too low at start of baking. Filling too juicy. Used shiny metal pans.
<p>Follow cookware manufacturer's instructions for oven temperature. Glassware and dark cookware such as Ecco's Baker's Secret require lowering the oven temperature by 25° F.</p>			

USING YOUR OVEN

BROILING HINTS

Broiling is a method of cooking tender foods by direct heat under the burner. The cooking time is determined by the distance between the meat and the burner, the desired degree of doneness and the thickness of the meat.

Broiling requires the use of the broiler pan and insert. The correct position of the insert in the pan is very important. The broiler insert should be placed in the pan so grease will drain freely. Improper use may cause grease fires.

The broiler insert CANNOT be covered with aluminum foil as this prevents fat from draining into pan below. However,

for easier cleaning, the broiler pan can be lined with foil. Do not use disposable broiler pans. They do not provide a separate tray.

Prepare meat by removing excess fat and slashing remaining fat, being careful not to cut into meat. This will help keep meat from curling.

Place broiler pan on the recommended rack position. For brown exterior and rare interior, the meat should be close to the burner. Place further down if you wish meat well done. Excessive smoking may occur if meat is placed too close to the oven burner.

NOTE: Below are recommended rack positions. Remember, the closer to the flame, the quicker the food cooks. When broiling is completed, remove broiler pan from compartment. Grease left in the pan can catch fire if the oven is used without removing the broiler pan.

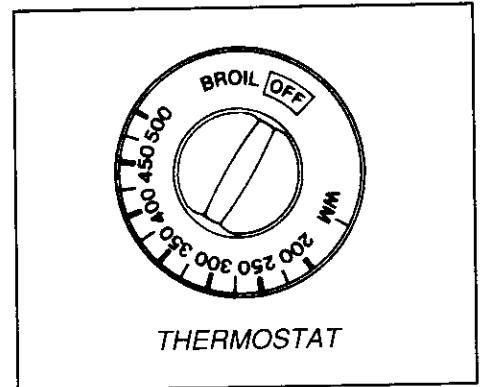

BROILING CHART

TYPE OF FOOD	RACK POSITION*	DONENESS	TOTAL TIME
STEAKS 1-inch	2	140°F rare	8 to 12 min.
	2	160°F medium	12 to 16 min.
	2	170°F well done	16 to 22 min.
1 1/2-inches	2	140°F rare	14 to 18 min.
	2	160°F medium	18 to 22 min.
	2	170°F well done	22 to 30 min.
HAMBURGER PATTIES 3/4 to 1-inch	2	140°F rare	10 to 12 min.
	2	160°F medium	12 to 14 min.
	2	170°F well done	14 to 18 min.
CHICKEN HALVES**	3	185°F well done	40 to 50 min.
FISH FILLETS, fresh or thawed 1-inch	2	flaky	14 to 20 min.
HAM SLICE, precooked 1/2-inch	2	140°F	8 to 15 min.
BACON	2	crisp	5 to 10 min.
PORK CHOPS 1/2-inch	2	170°F well done	15 to 20 min.

* Rack 1 is the top rack position.

** Turn thermostat to 450°F.

CARE AND CLEANING

PARTS	CLEANING AGENTS	DIRECTIONS
Baked Enamel Oven door	Soap & water. Paste of baking soda & water.	Use a dry towel or cloth to wipe up spills, especially acid spills, as soon as they occur. (This is especially important for white surfaces.) When surface is cool, wash with soap and water. Do not use abrasive or harsh cleaning liquids and powders or oven cleaners. These will scratch and permanently damage the finish. Dry with a soft cloth.
Broiler pan & insert	Soap & water. Plastic scouring pad. Soap filled scouring pad.	Remove from oven after use. Cool then pour off grease. Place soapy cloth over insert and pan; let soak to loosen soil. Wash in warm soapy water. Use soap filled scouring pad to remove stubborn soil. Clean in dishwasher if desired.
Control knob	Soap & water.	To remove knobs for cleaning, gently pull forward. Wash in mild detergent and water. Do not use abrasive cleaning agents. They will scratch finish and remove markings. Rinse, dry and replace. Turn on to see if knob has been replaced correctly.
Glass Oven window	Soap & water. Paste of baking soda & water. Window cleaning fluid.	Wash with soap and water. Remove stubborn soil with paste of baking soda and water. To avoid inside staining of oven door glass, do not oversaturate cloth. Do not use abrasive materials such as scouring pads, steel wool or powdered cleaning agents. They will damage glass. Rinse with clear water and dry.
Metal finishes Trim parts Control panel	Soap & water. Paste of baking soda & water.	Wash with soap and water. Remove stubborn soil with paste of baking soda and water. Do not use oven cleaners, abrasive or caustic agents. They will damage the finish.
Oven racks	Soap & water. Cleansing powders & plastic pads. Soap filled scouring pad.	Clean with soapy water. Remove stubborn soil with cleansing powder or soap filled scouring pad. Rinse and dry.
Plastic or vinyl finishes Door handles Overlays Knobs	Soap & water. Paste of baking soda & water. Non-abrasive plastic pad or sponge.	Never use oven cleaners, abrasive or caustic liquid or powdered cleaning agents on plastic finishes. These cleaning agents will scratch or mar finish. To prevent staining or discoloration, wipe up fat, grease or acid (tomato, lemon, vinegar, milk, fruit juice, marinade) immediately with a dry paper towel or cloth. When surface is cool, clean with soap and water; rinse, and dry.
Porcelain finish interior (See page 5 for continuous clean oven instructions)	Soap & water. Cleansing powders & plastic pads. Commercial oven cleaner.	Porcelain enamel is glass fused on metal. It may crack or chip with misuse. Clean with soap and water when parts are cool. NEVER WIPE OFF A WARM OR HOT ENAMEL SURFACE WITH A DAMP CLOTH. THIS MAY CAUSE CRACKING AND CHIPPING. Clean oven interior with soap and water. Use cleansing powders or a plastic scouring pad to remove stubborn soil. Wipe acid or sugar stains as soon as the oven is cool as these stains may discolor or etch the porcelain. Do not use metallic scouring pads as they will scratch the porcelain. Commercial oven cleaners can NOT be used on the Continuous Cleaning oven finish. Oven cleaners can be used on the porcelain oven but follow manufacturer's directions.
Silicone rubber Door gasket	Soap & water.	Wash with soap and water, rinse and dry. Do not remove door gasket.

MAINTENANCE

ELECTRICAL CONNECTION

Appliances which require electrical power are equipped with a three-prong grounding plug which must be plugged directly into a properly grounded three-hole 120 volt electrical outlet.

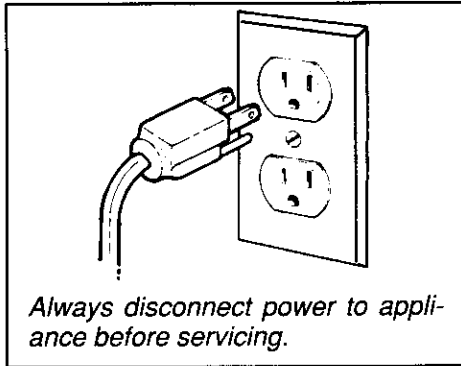

If an ungrounded, two-hole or other type electrical outlet is encountered, IT IS THE PERSONAL RESPONSIBILITY OF THE APPLIANCE OWNER TO HAVE RECEPTACLE REPLACED WITH A PROPERLY GROUNDED THREE HOLE ELECTRICAL OUTLET. The three-prong grounding plug is provided for protection against shock hazards. DO NOT CUT OR REMOVE THE THIRD GROUNDING PRONG FROM THE POWER CORD PLUG.

HOW TO REMOVE OVEN FOR CLEANING AND SERVICING

When necessary, follow these procedures to remove appliance for cleaning or servicing:

1. Shut-off gas supply to appliance.
2. Disconnect electrical supply to appliance.
3. Disconnect gas supply tubing to appliance.
4. Remove screws that secure appliance to cabinet. Remove appliance from cabinet.
5. Reverse procedure to reinstall. If gas line has been disconnected, check for gas leaks after reconnection. (See Installation Instructions for gas leak test method.) Note: A trained serviceman should make the gas installation, disconnection, and re-connection of gas supply to the appliance.

LIGHT REPLACEMENT

Before replacing oven light bulb, DISCONNECT POWER TO OVEN. Be sure bulb and oven parts are cool. Do not touch a hot bulb with a damp cloth as the bulb may break.

To replace oven light: Use a dry pot holder, to prevent possible harm to hands; **very carefully** remove bulb. Replace with a 40 watt APPLIANCE bulb. Reconnect power to the oven.

SERVICE

BEFORE CALLING A SERVICE TECHNICIAN, CHECK THE FOLLOWING:

PROBLEM	CAUSE	CORRECTION
1. Oven burner fails to light	<ul style="list-style-type: none"> a. power supply not connected (pilotless ignition) b. pilot is out (pilot ignition) c. power failure (pilotless ignition) 	<ul style="list-style-type: none"> a. connect power, check circuit breaker or fuse box b. see page 6 to light pilots c. glo-bar ignition system, see page 6
2. Oven temperature inaccurate <ul style="list-style-type: none"> • food takes too long or cooks too fast • pale browning • food over-done on outside and under-done in center • over browning 	<ul style="list-style-type: none"> a. oven not preheated b. incorrect rack position c. incorrect use of aluminum foil d. oven bottom incorrectly replaced e. oven thermostat sensing device out of holding clip(s) 	<ul style="list-style-type: none"> a. preheat oven 3 to 5 minutes b. see page 7 c. see page 8 d. replace oven bottom correctly e. reinstall sensing device securely into clip(s) See Problem Chart on page 9.
3. Clock and/or oven light does not work	<ul style="list-style-type: none"> a. power supply not connected (pilotless ignition) b. burned out light bulb c. malfunctioning switch, starter or ballast d. malfunctioning clock or loose wiring 	<ul style="list-style-type: none"> a. connect power supply, check circuit breaker or fuse box b. replace light bulb c. call serviceman to check d. call serviceman to check

SERVICING

Electrical supply, if equipped, must be disconnected from the wall outlet before servicing appliance. Do not repair or replace any part of your range unless specifically recommended in this manual. All other servicing should be referred to a qualified technician.

HOW TO OBTAIN SERVICE

When your appliance requires service or replacement parts, contact your Dealer or Authorized Servicer. Use only genuine factory or Maycor parts if replacement parts are necessary. Consult the Yellow Pages in your telephone directory under appliance for the service center nearest you. Be sure to include your name, address, and phone num-

ber, along with the model and serial numbers of the appliance. (See front cover for location of your model and serial numbers.)

If you are unable to obtain service, write to us. Our address is found on the rating plate. See front cover for location of rating plate.

If you are not satisfied with the local response to your service requirements, call or write MAYCOR Appliance Parts and Service Company, 240 Edwards Street, S.E., Cleveland, TN 37311, (615) 472-3500. Include or have available the complete model and serial numbers of the appliance, the name and address of the dealer from whom you purchased the appliance, the date of

purchase and details concerning your problem.

If you did not receive satisfactory service through your servicer or Maycor you may contact the Major Appliance Consumer Action Panel by letter including your name, address, and telephone number, as well as the model and serial numbers of the appliance.

Major Appliance Consumer Action Panel
20 North Wacker Drive
Chicago, IL 60606

MACAP (Major Appliance Consumer Action Panel) is an independent agency sponsored by three trade associations as a court of appeals on consumer complaints which have not been resolved satisfactorily within a reasonable period of time.

FULL ONE-YEAR WARRANTY

DOMESTIC GAS OR ELECTRIC RANGE

Maycor Appliance Parts & Service Company will repair or replace, without charge, any part of your product which has a defect in material or workmanship during the first year after the date of the original installation. This warranty extends to any owner during the one-year warranty period.

LIMITED 5 YEAR WARRANTY

On electric ranges equipped with solid disc or smoothtop heating elements, and on gas ranges with sealed burners, for an additional 4 year period beyond the first year of the general coverage of this warranty, Maycor will replace any of the solid disc or smoothtop heating elements, or sealed burners which fail to heat as a result of defective workmanship or material. Additionally, Maycor will replace any smoothtop cooking surface which cracks or breaks during normal household cooking. These parts must be installed by a qualified person. Any labor charge required for replacement is not covered by this warranty.

HOW TO OBTAIN SERVICE

To obtain the repair or replacement of a defective part under these warranties, you should contact the dealer from whom you purchased the appliance or a servicer he designates.

WHAT IS NOT COVERED BY THESE WARRANTIES

1. Conditions and damage resulting from improper installation, delivery, unauthorized repair, modification, or damage not attributable to a defect in material or workmanship.
2. Conditions resulting from damage, such as: (1) improper maintenance, (b) misuse, abuse, accident, or (c) incorrect electrical current or voltage.
3. Warranties are void if the original serial number has been removed, altered, or cannot be readily determined.
4. Light bulbs.
5. Any product used for other than normal household use. It does not extend to products purchased for commercial or industrial use.
6. Any expense incurred for service calls to correct installation errors or to instruct you on how to use the products.
7. CONSEQUENTIAL OR INCIDENTAL DAMAGES SUSTAINED BY ANY PERSON AS A RESULT OF ANY BREACH OF THESE WARRANTIES OR ANY IMPLIED WARRANTY. Some states do not allow the exclusion or limitation of consequential or incidental damages, so the above exclusion may not apply to you.

ADDITIONAL HELP

If you are not satisfied with the local response to your service requirements and wish to contact Maycor, please address your letter to the Customer Relations Department, Maycor Parts & Service Company, 240 Edwards Street, S.E., Cleveland, TN 37311 or call (615) 472-3500. To save time, your letter should include the complete model and serial numbers of the warranted appliance, the name and address of the dealer from whom you purchased the appliance, the date of purchase and details concerning your problem.

These warranties are the only written or expressed warranties given by Maycor. No one is authorized to increase, alter, or enlarge Maycor's responsibilities or obligations under these warranties. These warranties give you specific legal rights, and you may also have other rights which vary from state to state.

8109P059-60
(6/91)

FULL ONE-YEAR WARRANTY

DOMESTIC GAS OR ELECTRIC RANGE

Maycor Appliance Parts & Service Company will repair or replace, without charge, any part of your product which has a defect in material or workmanship during the first year after the date of the original installation. This warranty extends to any owner during the one-year warranty period.

LIMITED 5 YEAR WARRANTY

On electric ranges equipped with solid disc or smoothtop heating elements, and on gas ranges with sealed burners, for an additional 4 year period beyond the first year of the general coverage of this warranty, Maycor will replace any of the solid disc or smoothtop heating elements, or sealed burners which fail to heat as a result of defective workmanship or material. Additionally, Maycor will replace any smoothtop cooking surface which cracks or breaks during normal household cooking. These parts must be installed by a qualified person. Any labor charge required for replacement is not covered by this warranty.

HOW TO OBTAIN SERVICE

To obtain the repair or replacement of a defective part under these warranties, you should contact the dealer from whom you purchased the appliance or a servicer he designates.

WHAT IS NOT COVERED BY THESE WARRANTIES

1. Conditions and damage resulting from improper installation, delivery, unauthorized repair, modification, or damage not attributable to a defect in material or workmanship.
2. Conditions resulting from damage, such as: (1) improper maintenance, (b) misuse, abuse, accident, or (c) incorrect electrical current or voltage.
3. Warranties are void if the original serial number has been removed, altered, or cannot be readily determined.
4. Light bulbs.
5. Any product used for other than normal household use. It does not extend to products purchased for commercial or industrial use.
6. Any expense incurred for service calls to correct installation errors or to instruct you on how to use the products.
7. CONSEQUENTIAL OR INCIDENTAL DAMAGES SUSTAINED BY ANY PERSON AS A RESULT OF ANY BREACH OF THESE WARRANTIES OR ANY IMPLIED WARRANTY. Some states do not allow the exclusion or limitation of consequential or incidental damages, so the above exclusion may not apply to you.

ADDITIONAL HELP

If you are not satisfied with the local response to your service requirements and wish to contact Maycor, please address your letter to the Customer Relations Department, Maycor Parts & Service Company, 240 Edwards Street, S.E., Cleveland, TN 37311 or call (615) 472-3500. To save time, your letter should include the complete model and serial numbers of the warranted appliance, the name and address of the dealer from whom you purchased the appliance, the date of purchase and details concerning your problem.

These warranties are the only written or expressed warranties given by Maycor. No one is authorized to increase, alter, or enlarge Maycor's responsibilities or obligations under these warranties. These warranties give you specific legal rights, and you may also have other rights which vary from state to state.

8109P059-60
(6/91)