

Dishwasher Guide



Table of Contents

For Future Assistance 1

Safety Instructions 1

Check Before Washing 2

 Hot Water

 Rinse Aid

 Detergents

Loading 3

Cycles/Options At
A Glance 4

Additional Information 5

 Adding A Forgotten Item

 Cleaning

 Storing

What Can & Cannot
Be Washed 6

Common Questions
& Answers 7-9

Notes 10

Warranty Back Page

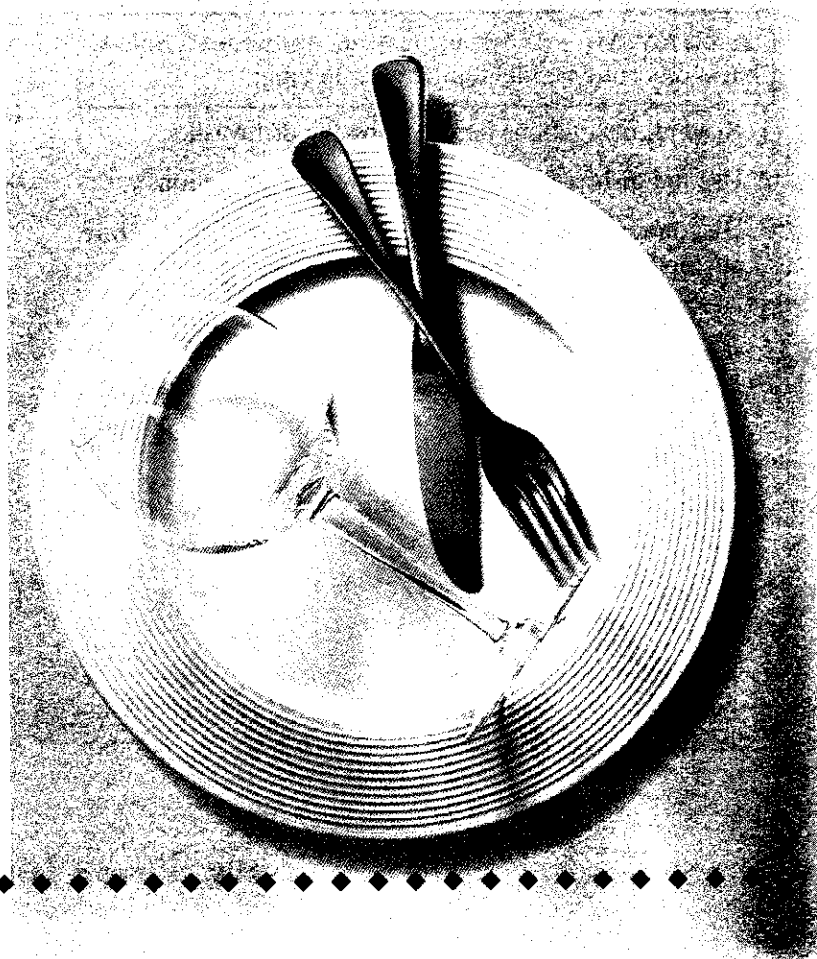

For Future Assistance

Thank you for selecting a new Jenn-Air dishwasher!

We appreciate your purchase decision and feel confident you will be happy with this appliance for years to come. For best results, we suggest reading this material to help you properly operate and maintain the appliance.

Should you ever need our future assistance with your dishwasher, a complete model and serial number recorded in the spaces below will be extremely helpful. These numbers can be found in the upper left corner of the tub opening.

Model Number

Serial Number

In addition, keep your sales slip or cancelled check should any warranty service be required. Proof of original date of purchase is needed. For additional questions, please contact us:

Jenn-Air
403 West Fourth Street North
Newton, Iowa 50208

▲ WARNING - Check with the installer to make sure the appliance has been properly grounded to avoid possible electrical shock. Be sure you read the Important Personal Safety Instructions before you start to use this dishwasher.

In our continuing effort to improve the quality of our dishwashers, it may be necessary to make changes to the appearance without revising this guide.

Important Safety Instructions

Products with a  label have been listed with Underwriter's Laboratories, Inc. – those with a CSA tag have been listed with Canadian Standards Association. Nevertheless, as with any other equipment using electricity and moving parts, there is a potential hazard.

▲ WARNING – When using your dishwasher, follow basic precautions, including the following:

1. Read all instructions before using the dishwasher.
2. Use the dishwasher only for its intended function.
3. Disconnect electrical power to dishwasher before attempting to service.
4. To avoid electrical shock hazard, the sides and back must be enclosed and the front panels must be attached before electrical power is applied to the dishwasher. Refer to the installation instructions for proper grounding procedures.
5. Connect to a properly rated, protected and sized power supply circuit to avoid electrical overload.
6. Children should never be permitted to operate, or play in, with, or around this dishwasher.
7. To reduce the risk of injury when loading items to be washed, sharp or pointed items should be located with the handles up. Also, load sharp items so they are not likely to damage the door seal.
8. Be careful not to touch the heating element on the bottom of the tub during or at the completion of a cycle. It may be hot.
9. Use only detergents and rinse additives designed for an automatic dishwasher. Never use soap, laundry detergent, or hand washing detergent in your dishwasher. Keep these products out of reach of children.
10. Do not sit, stand on or abuse the door or dish racks of the dishwasher.
11. Under certain conditions, hydrogen gas may be produced in a hot water system that has not been used for two weeks or more. **Hydrogen gas is explosive.** If the hot water system has not been used for such a period, turn on all hot water faucets and let the water flow from each for several minutes. This will release any accumulated hydrogen gas. As the gas is flammable, do not smoke or use an open flame during this process.
12. Do not wash plastic items unless marked "dishwasher safe" or the equivalent. For plastic items not so marked, check the manufacturer's recommendations.
13. Do not tamper with controls.
14. Always remove the door to the washing compartment when removing an old dishwasher from service or discarding it.

Save These Instructions

Hot Water

For best results, hot water is necessary. The incoming water temperature should be 120-140°F. To check the water temperature, turn on the hot water faucet nearest the dishwasher and let it run into a glass in the sink. Place a candy thermometer in the glass and check the temperature once it has stopped rising. If the temperature is below 120°F, have a qualified person raise the water heater setting. Additionally:

- ✦ If the outside temperature is unusually low, or if your water travels a long distance from the water heater to the dishwasher, you may need to increase your home's water heater setting and/or select water heating options on your dishwasher.
- ✦ If you have not recently used hot water, the water in the pipes will be cold. Run water at the sink until the water is hot. Then start the dishwasher.
- ✦ If you've recently done laundry or used hot water for showers, your water heater may need time to recover before operating the dishwasher.

Rinse Aid

Rinse aids come in solid or liquid form. When using a solid rinse aid, fasten it to the back right corner of the lower rack. Replace the rinse aid when the container is empty.

A liquid rinse aid dispenser automatically releases a measured amount of additive into the final rinse portion of each cycle.

To fill the dispenser, turn the cap counterclockwise to open. Pour the rinse aid into the reservoir. Replace the cap and be sure it is securely in place before closing the dishwasher door. Check monthly.

Detergent

Use a detergent designed specifically for use in an automatic dishwasher. Other types (laundry, hand soap, etc.) will cause oversudsing. For best results be sure to use fresh detergent and store it in a cool, dry place (not under the sink).

The amount of detergent to use depends on the water hardness (measured in grains per gallon-gpg) and the amount of soil on the dishes.

A basic guideline is:

- 1.) Use 1 teaspoon of detergent per grain of water hardness.
- 2.) A minimum of 3 teaspoons is needed in soft water.*
- 3.) For concentrated detergents, decrease the amount by half.

If the water hardness is 15 grains or harder, it will be virtually impossible to get good results with any dishwasher. The only solution is a mechanical water softener to improve water quality and detergent effectiveness.

Quick Tips...

- ◆ **Use Hot Water** to dissolve and activate detergent, dissolve greasy food soils and improve drying.
- ◆ **Use a Rinse Aid** regularly to improve drying results and reduce spotting and filming.
- ◆ **Use the Proper Detergent Amount** for best soil removal, good drying results and prevention of filming, etching and spotting.
- ◆ **Load Properly** to ensure soiled surfaces get adequate wash action. (See page 3).
- ◆ **Select the Proper Cycle & Options** based on the amount of food soil, water conditions and expected drying results. (See pages 4-5).

DETERGENT USAGE GUIDE (POWDER OR LIQUID)

CYCLES	SOFT WATER (0-3 grains)		MEDIUM WATER (4-9 grains)		HARD WATER (10-12 grains)	
	Main Cup	Pre Wash	Main Cup	Pre Wash	Main Cup	Pre Wash
Pots & Pans Normal /Heavy	3 tsp. minimum	3 tsp. minimum	4-9 tsp.	4-9 tsp.	10-12 tsp.	10-12 tsp.
Light/China	3 tsp. min.	none	4-9 tsp.	none	10-12 tsp.	none
Rinse & Hold	Use no detergent		Use no detergent		Use no detergent	

* Your local water utility or state university extension service can tell you the degree of water hardness in your area.

3 Loading the Dishwasher

Top Rack

This rack is designed to hold glasses, cups, small plates, bowls, cookware etc. Bowls fit securely in the back right half of the top rack. Small plates or saucers can be loaded in front of bowls, facing the center.

Do not place glasses over the tines as this interferes with cleaning and drying results. Instead, rest glasses against tines or the side of the rack.

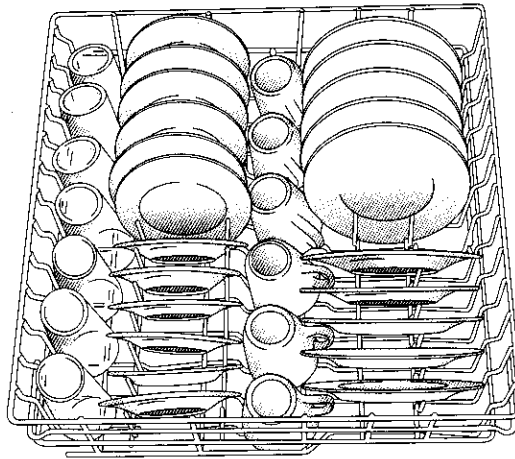

Bottom Rack

Large items may be placed in any convenient location in this rack. Keep soiled surfaces facing the center of the rack.

The back of this rack will accommodate a row of large plates or two rows of smaller plates. Serving bowls, pots and pans also fit across the back of the rack.

Small plates, saucers or shallow bowls may be loaded in the elevated area behind the wash tower to maximize loading space.

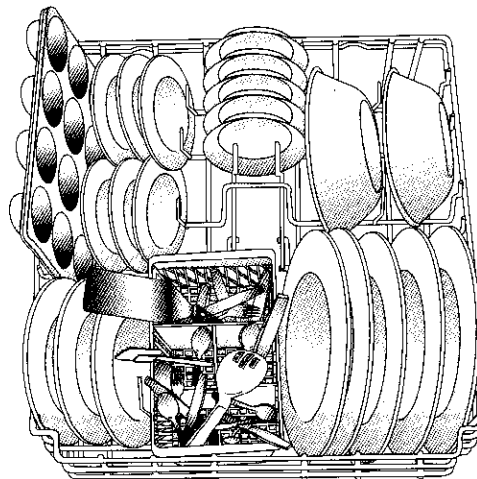
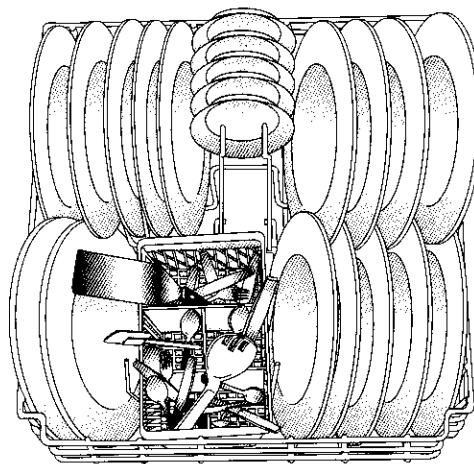

Removable Utensil Basket

Load utensils with some handles up and some down to prevent nesting. Place sharp or pointed items with the handles up.

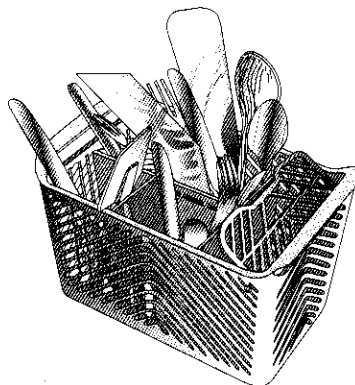

Helpful Hints...

- ◆ Scrape off bones, large food particles & excessive grease/oil.
- ◆ Mustard, lemon juice, mayonnaise, vinegar, and other acidic foods can damage stainless steel and should be rinsed off as soon as possible.
- ◆ Soak or scrub pieces with stubborn burnt-on foods. They need more energy to clean than the rest of the load.
- ◆ Starch from rice, potatoes, oatmeal, pasta, etc... requires more cleaning energy (longer cycle or more detergent).
- ◆ Load items so they are separated and facing center.
- ◆ Wedge, lightweight flat items next to the silverware basket or along the sides and back of the racks.
- ◆ Load items so they do not rest over the wash tower or extend beyond the racks.

Cycles/Options At A Glance 4

Your Jenn-Air dishwasher features various cycles to adjust to your specific load conditions. (Features may vary slightly depending on your model.) To start a cycle, simply turn the cycle selector knob clockwise to the desired cycle and press

the door until it latches. Each cycle will start with a 90 second drain before filling with water. This is normal. (Do not rotate selector knob counterclockwise.)

Cycle Selector Knob

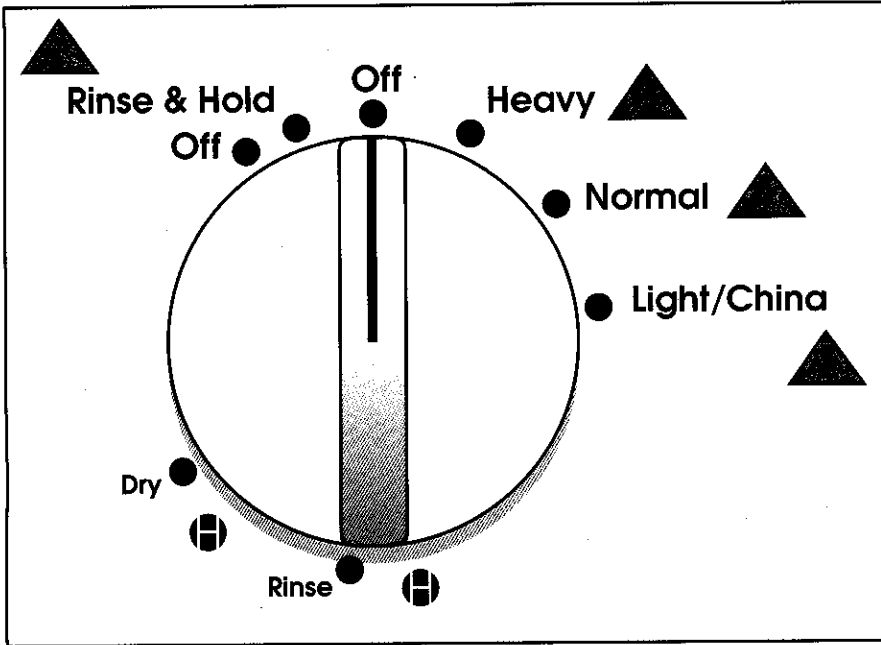

Rinse & Hold rinses dishes being held for a full load. This helps minimize any food odor from building up in the dishwasher.

Heavy is the longest wash cycle designed to handle loads of heavily soiled dishes, pots or pans.

Normal is designed for normally soiled dish loads.

Light/China is for lightly soiled loads or china and crystal.

CYCLE INFORMATION		
CYCLE	SEQUENCE	WATER USE
Rinse & Hold	Rinse Off	1.5 gallons
Heavy	PreWash 3 Rinses Main Wash 2 Rinses Dry	10.5 gallons
Normal	PreWash 2 Rinses Main Wash 2 Rinses Dry	9.0 gallons
Light/China	2 Rinses Main Wash 2 Rinses Dry	7.5 gallons

Heating Options

(Located on buttons on the left side of the panel.)

FAN DRY HEAT improves drying results by turning the heating element on during a portion of fan dry.

FAN DRY AIR turns the heating element off during the fan dry portion of the cycle. Towel drying of some items may be necessary.

Note: With either dry option, it is normal to notice vapor coming out of the vent area.

ACCU TEMP ON checks the main wash and final rinse water temperatures and will extend the heating and water circulation until proper water temperature is reached.

ACCU TEMP OFF cancels the water temperature checks in the main wash and final rinse.

5 Additional Information

Adding a Forgotten Item

For best cleaning, the forgotten item should be added early in the cycle.

1. Unlatch the door and wait until the sound of circulating water stops.
2. Open the door and add the item.
3. Close and latch the door. The cycle will continue at the point it was interrupted.

Cleaning

Clean the control panel and front panels with a lightly dampened cloth. Dry thoroughly. Do not use abrasives or sharp objects on the panel. They can damage it.

The inside normally takes care of itself. Occasionally check the tub bottom for any large pieces which may have collected. Periodically clean the edge of the door liner and gasket if any food spills are noticed.

To remove any odor, try one of the following:

- ✦ Put baking soda in both cups. Select the normal cycle and let the water circulate for about 10 minutes. Unlatch the door and let it sit overnight. Then relatch the door and let the cycle finish.
- ✦ Select the Normal cycle and let the dishwasher fill with water. Then open the door and pour 1 cup of chlorine bleach into the bottom of the dishwasher. Latch the door and let it complete the cycle.
- ✦ Try a lemon scent detergent and/or rinse aid to help periodically freshen the dishwasher interior.
- ✦ Run the dishwasher more frequently. Use the Rinse & Hold cycle (if available) to remove any food soil that may cause an odor.

Storing

If your dishwasher will be in storage or an unheated area exposed to freezing temperatures:

- ✦ Clean the dishwasher as explained above.
- ✦ Operate the drain portion twice to ensure most of the water is removed. Most dishwashers begin each cycle with a drain. For touch control models, press the Drain/Off pad.
- ✦ Disconnect the electrical supply and prop open the door.



What Can & Cannot Be Washed

Remember, it is the user's responsibility to determine if the item should be washed in a dishwasher.

Material	Usually Safe	Exceptions (not safe)	Special Instructions
Aluminum	Yes	Some colored anodized aluminum can fade.	If the item darkens or spots, remove by scouring with soap-filled steel wool pads.
Cast Iron	No	Iron will rust.	If in doubt, check with the manufacturer. Or test wash one piece daily for several weeks.
China & Stoneware	Yes	Antique, metal-trimmed, hand-painted or over-the-glaze patterns fade. Gold leaf will discolor.	Load securely to prevent movement. Check with manufacturer.
Crystal	Yes	Antique, metal-trimmed or painted patterns fade.	
Non-dishware items such as electronic air cleaner filters, furnace filters, paint brushes, etc.	No		Do not wash in dishwasher. It may damage, discolor or stain the dishwasher.
Glass	Yes	Milk Glass may yellow.	
Pewter	No	Pewter tarnishes.	
Plastics	Yes		If it doesn't say DISHWASHER SAFE, test one piece before dishwashing an entire set.
Stainless Steel	Yes		Rinse if not washing immediately. Salty or acidic foods stain if left on.
Sterling Silver and Silver plate	Yes	Don't put in same silverware basket with stainless steel. Contact between metals can damage silver. Don't wash copper utensils in the same load. Silver may get a brown film.	Rinse if not washing immediately. Salty or acidic foods stain if left on.
Non-stick coatings	Yes		
Tin	No	Tin can rust.	
Wood	No	Wood can warp, crack or lose its finish.	

7 Common Questions & Answers



<p>Dishwasher Won't Run?</p>	<ul style="list-style-type: none"> ◆ Be sure door is latched securely. ◆ Be sure the water is turned on. ◆ Check that the dial/pad is properly selected for a cycle. ◆ Allow time for select models to drain/pause before filling. ◆ Check your home's circuit breaker or fuse box.
<p>Unusual Noise?</p>	<ul style="list-style-type: none"> ◆ A water valve hiss during fill is normal. ◆ Water circulation sounds are normal. ◆ A ticking noise is a normal timer sound. ◆ A thumping sound may be a wash arm bumping an item that is extending beyond the racks. ◆ Chopping or grinding sounds may be heard during drain as the internal food disposer chops hard items like fruit seeds, nuts etc. ◆ Humming during drain is normal. ◆ A snap noise is the detergent cup lid hitting the door liner when the dishwasher door is opened at the end of the cycle. This is normal. ◆ Proper installation affects the noise level.
<p>Dishes Don't Dry?</p>	<ul style="list-style-type: none"> ◆ Check the rinse aid dispenser to see if it needs refilling. ◆ Select the Drying Heat option. ◆ Check incoming water temperature. ◆ Load properly. Dishes shouldn't nest together. Avoid overloading. ◆ Unload the bottom rack first. Water from dishes in the top rack may be spilling into the bottom rack. ◆ Plastic and teflon items have a porous surface and tend to hold water. Towel drying may be required. ◆ Glasses, cups, etc., with concave bottoms will hold water.
<p>Unclean Dishes And Flatware?</p>	<ul style="list-style-type: none"> ◆ Check incoming water temperature. ◆ Run hot water at the sink before starting the dishwasher. ◆ Select water heat (select models). ◆ Check water hardness and adjust detergent amount accordingly. ◆ Use fresh detergent stored in a cool dry place. ◆ Select proper cycle for the soil level. ◆ Load items so they do not block the wash arms or center tower. ◆ Load the utensil basket with some handles up and some down to prevent nesting. ◆ Do not place glasses over tines.
<p>Detergent Left In Dispenser Cups?</p>	<ul style="list-style-type: none"> ◆ Check that the cycle is completed. ◆ Be sure dispenser is not blocked. ◆ Use fresh detergent stored in a cool, dry place.
<p>Stains Or Marks On Dishes Or Tub?</p>	<p>Aluminum utensils can leave marks when they rub against other things. Leave a slight space between items. Iron deposits in the water can leave a yellow, brown or orange film on dishes. A filter may be needed or periodically use RoVer Rust Remover.* Food soil stains normally require hotter water and more detergent to remove and prevent.</p>

<p>Dishes Chipped?</p>	<ul style="list-style-type: none"> ◆ Rough handling can cause chipping. Load with care. Make sure glassware and china are secure and can't jar loose. Do not load glasses over tines. Make sure tall glasses and stemware will clear the top of the tub when you push the rack into the dishwasher. ◆ Refer to the previous chart on "What Can and Cannot Be Washed".
<p>Spots And Film On Glasses And Flatware?</p>	<p>Spotting can be caused by all these things:</p> <ul style="list-style-type: none"> ◆ Extremely hard water. ◆ Low inlet water temperature. ◆ Overloading the dishwasher. ◆ Improper loading. ◆ Old or damp detergent. ◆ Rinse aid dispenser empty. ◆ Too little detergent. <p>Due to the varying local water conditions and personal preferences, try different brands of detergent to find one that gives the best results for you.</p> <p>To remove the spots and film from glassware:</p> <ol style="list-style-type: none"> 1. Remove all metal utensils from the dishwasher. 2. DO NOT ADD DETERGENT. 3. Select the NORMAL WASH cycle. 4. Start the dishwasher and allow to run for approximately 20 minutes. The dishwasher will now be in the main wash. 5. Then open the door and pour 1/2 cup (125ml) of white vinegar into the bottom of the dishwasher. 6. Close the door and allow the dishwasher to complete the cycle. Using a vinegar rinse more than twice a month? Consider a home water softener.
<p>Cloudy Glassware?</p>	<p>If vinegar doesn't remove the cloudiness, it is "etching." The film is permanent.</p> <p>To prevent:</p> <ol style="list-style-type: none"> 1. Use less detergent if you have soft water. 2. Avoid manually pre-rinsing the dishes. 3. Lower the temperature of water entering the dishwasher to 120° F.
<p>Dishwasher Won't Drain?</p>	<ul style="list-style-type: none"> ◆ If hooked up to a food waste disposer, be sure the knock-out is removed from the disposer inlet. ◆ Be sure the drain hose is elevated at least 32" so water cannot siphon back into the tub. ◆ Check for food obstruction in the drain or disposer. ◆ Check drain hose for a kink. ◆ Check your home's circuit breaker or fuse box. ◆ Check that the cycle is completed.

Q & A Continued

Suds In The Tub?	Sudsing detergents are not meant for dishwashers. USE ONLY AUTOMATIC DISHWASHER DETERGENTS TO AVOID SUDSING. To remove suds from the tub: <ol style="list-style-type: none">1. Open the dishwasher door and sprinkle 1 cup of salt on top of the suds to help evaporate them.2. Close and latch the dishwasher.3. Turn the dial until a drain is reached or select the drain pad.4. Repeat if necessary.
Dishwasher Leaks?	<ul style="list-style-type: none">◆ Check that the dishwasher is level. (Refer to the Installation Instructions.)◆ Suds can cause the dishwasher to overflow. Measure the detergent carefully and use only detergents designed for use in a dishwasher. Less detergent is needed in soft water. Try another brand if sudsing continues.◆ Follow directions closely on how to add a forgotten item.◆ To avoid rinse aid leaking from the dispenser, be sure the lid is securely attached. Wipe up any accidental spills.
Odor?	<ul style="list-style-type: none">◆ Dishwashers will have a “new” smell when installed. This will decrease with time.◆ Soiled dishes held too long. Use the Rinse & Hold, if available.◆ Dishwasher not draining properly.◆ A chemical odor is usually due to chlorine bleach in dishwashing detergents. You may want to try another brand.

** Brand names are trademarks of the respective manufacturer.*

For further help, call Jenn-Air Customer Assistance: 1-800-688-1100.

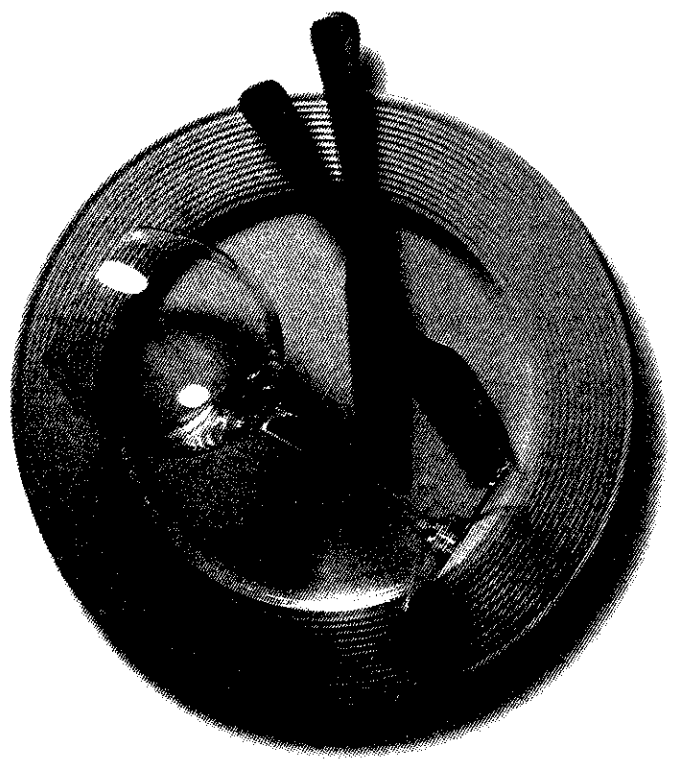

JENN-AIR Dishwasher Warranty

FULL ONE-YEAR WARRANTY

Any part which fails in normal home use during the first year after the date of original retail purchase will be repaired or replaced free of charge.

LIMITED Two Year WARRANTY

Any part which fails in normal home use during the second year from the date of original retail purchase, will be repaired or replaced free of charge for the part itself, with the owner paying all other costs, including labor.

LIMITED Five Year WARRANTY on Wash System and Solid State Controls

Any parts of the system including the complete power module assembly, center spray nozzle, spray arms, top wash arm hose, motor, AND—on Computer Touch Control Models only—any microprocessor and touch pad assemblies which fail in normal home use during the second through the fifth year from the date of original retail purchase, will be repaired or replaced free of charge for the part itself, with the owner paying all costs, including labor.

LIMITED Five Year Rack WARRANTY (Available on Select Models)

Should the Duralon™ coated racks rust during the five year period starting from the date of original retail purchase, repair or replacement will be made free of charge for the part itself, with the owner paying all costs, including labor.

Full TWENTY Year WARRANTY Against Leaks on Dishwasher Tub and Door Liner

Should a water leak develop in the tub or door liner in normal home use during the TWENTY YEAR period starting from the date of original retail purchase, repair or replacement of the tub and/or door liner will be made FREE OF CHARGE. These full warranties and the limited warranties apply when the appliance is located in the United States or Canada. Appliances located elsewhere are covered by the limited warranties only, which include parts which fail during the first year.

Canadian Residents

This warranty covers only those appliances installed in Canada that have been listed with Canadian Standards Association unless the appliances are brought into Canada due to transfer of residence from the United States to Canada.

To Receive Warranty Service

- First:** Call or write the Jenn-Air dealer from whom your appliance was purchased or the authorized service firm designated by the dealer. If you have moved from the selling dealer's service area call or write any authorized Jenn-Air dealer or authorize service firm at your new location. Check the telephone directory yellow pages to identify the dealer or service firm in your area.
- Second:** Should your contact with the dealer or the service firm fail to satisfactorily resolve the problem, contact the manager of the dealership or the manager of the service firm for assistance.
- Third:** Should you not receive satisfactory warranty service from one of the above or need help in identifying an authorized service firm write Jenn-Air Customer Assistance, c/o Maytag Customer Service, P.O. Box 2370 Cleveland, TN 37320-2370, and arrangements for warranty service will be made. If the problem is urgent, call Jenn-Air Customer Assistance, c/o Maytag Customer Service at (800) 688-1100

When contacting Jenn-Air Customer Assistance, c/o Maytag Customer Service, be sure to include the model and serial number of your appliance, the name and address of the dealer from whom you purchased the appliance and the date of purchase.

This Warranty gives you specific legal rights, and you may also have other rights that vary from state to state.

Should you still have a problem, write to Major Appliance Consumer Action Program, 20 North Wacker Drive, Chicago, Illinois 60606. MACAP is an industry sponsored but independent group of consumer experts who receive and act on complaints from appliance owners.

NOTE: When writing about an unsolved service problem, please include the following information:

- (a) Your name, address and telephone number;
- (b) Model number and serial number (found on the upper left corner of the tub opening) of your appliance;
- (c) Name and address of your dealer and the date the appliance was purchased;
- (d) A clear description of the problem you are having.
- (e) Water hardness, detergent brand and amount, water temperature, and cycle used.

Jenn-Air • 403 West Fourth Street North • Newton, Iowa 50208