

# TABLE OF CONTENTS

	Page
<b>For Future Reference</b> .....	1
<b>Consumer Publications</b> .....	1
<b>Safety Instructions</b> .....	2
<b>Using Your Dishwasher</b> .....	3-7
• Hot Water is Essential .....	3
• Preparing Dishes.....	3
• Loading Your Dishwasher .....	3-5
• Using Detergent and Rinse Aid .....	6-7
• Connecting a Convertible Dishwasher .....	7
<b>Selecting Cycles and Options/Starting Dishwasher</b> .....	8-9
<b>Special Tips</b> .....	10-13
• For Best Results.....	10
• Water Conditions .....	10-11
• Energy Saving Tips .....	11
• What Can and Cannot Be Washed.....	12
• Caring for Dishwasher .....	13
• Changing Panels.....	13
<b>Before You Call For Service</b> .....	14-15
<b>Warranty</b> .....	16

## FOR FUTURE REFERENCE

Congratulations on your choice of a Maytag Jetclean™ dishwasher. As you use your new dishwasher we know you will appreciate the many features that provide unsurpassed cleaning and capacity along with energy efficiency and dependability.

On the following pages you will find a wealth of information regarding all aspects of your beautiful new dishwasher. By following these instructions carefully, you will be able to achieve excellent results with your dishwasher. Should you have any questions about using your Maytag dishwasher, contact us. Be sure to provide the model number of your dishwasher.

MAYTAG COMPANY  
CONSUMER EDUCATION  
ONE DEPENDABILITY SQUARE  
NEWTON, IOWA 50208  
(515) 791-8911  
(Mon.-Fri., 8 am-5 pm CST)

For future reference we suggest you retain this manual after recording the model number and serial number of this dishwasher in the spaces provided. This information can be found on the data plate located on the upper left corner of the tub opening.

Model Number

Serial Number

**WARNING - Check with installer to make sure appliance has been grounded to avoid possible electrical shock. Be sure you read the IMPORTANT PERSONAL SAFETY INSTRUCTIONS on page 2 before you start to use this dishwasher.**

## CONSUMER PUBLICATIONS

For additional information order the following booklets from Maytag at the prices indicated. Send your name, address, booklet title, form number and payment to: Consumer Education Dept., Maytag Co., One Dependability Square, Newton, IA 50208. Allow 6-8 weeks for delivery.

- Innovative Ideas for Today's Kitchens — 22PR.....\$1.00
- Before You Call (Appliance Servicing Tips) — 206YG .....50¢
- Appliance Buying Guides .....50¢ EACH
- Washer — 211YG
- Dryer — 212YG
- Dishwasher — 213YG
- Electric Range — 214YG
- Gas Range — 215YG
- Refrigerator — 276YG

## IMPORTANT PERSONAL SAFETY INSTRUCTIONS

Products with a  label have been listed with the Underwriters' Laboratories, Inc. – those with a CSA tag have been listed with Canadian Standards Association. Nevertheless, as with any other equipment using electricity and moving parts, there is a potential hazard. When using your dishwasher, follow basic precautions, including the following:

1. Read all instructions before using the dishwasher.
2. Use the dishwasher only for its intended function.
3. Disconnect electrical power to dishwasher before attempting to service.
4. To avoid electrical shock hazard, the sides and back must be enclosed, and the front panels must be attached before electrical power is applied to the dishwasher. Refer to the installation instructions for proper grounding procedures.
5. Connect to a properly rated, protected and sized power supply circuit to avoid electrical overload.
6. Children should never be permitted to operate, or play in, with, or around this dishwasher.
7. To reduce the risk of injury when loading items to be washed, sharp or pointed items should be located with the handles up. Also, load sharp items so they are not likely to damage the door seal.
8. Be careful not to touch the heating element on the bottom of the tub during or at the completion of a cycle. It may be hot.
9. Use only detergents and rinse additives designed for an automatic dishwasher. Never use soap, laundry detergent, or hand washing detergent in your dishwasher. Keep these products out of the reach of children.
10. Do not sit, stand on or abuse the door or dish racks of the dishwasher.
11. Under certain conditions, hydrogen gas may be produced in a hot water system that has not been used for two weeks or more.  
**Hydrogen gas is explosive.** If the hot water system has not been used for such a period, turn on all hot water faucets and let the water flow from each for several minutes. This will release any accumulated hydrogen gas. As the gas is flammable, do not smoke or use an open flame during this process.
12. Do not wash plastic items unless marked "dishwasher safe" or the equivalent. For plastic items not so marked, check the manufacturer's recommendations.
13. Do not tamper with controls.
14. Always remove the door to the washing compartment when removing an old dishwasher from service or discarding it.

**SAVE THESE INSTRUCTIONS**

## USING YOUR DISHWASHER

### Hot Water is Essential

For proper performance of your dishwasher, hot water is necessary to activate the dishwasher detergent and melt fatty food soils. Set your water heater to deliver 120°F water to the dishwasher. If, for any reason, the temperature of the water being delivered by the water heater should be below 120°F, select the Temp Boost Sensor option to have your dishwasher heat the water until proper temperature is reached.

To check water temperature, turn on the hot water faucet nearest the dishwasher. Let water run into a glass in the sink until it is as hot as possible, then check with a candy or meat thermometer. If the temperature at the faucet is below 120°F (49°C), have a qualified person raise the water heater thermostat setting.

### Preparing Dishes

- It is not necessary to rinse dishes before placing them in your Maytag dishwasher. Simply scrape off bones and large pieces of food. The food disposer in your dishwasher can handle a variety of items such as pits, fruit seeds, popcorn and toothpicks. These items will be chopped into small pieces during drain and removed with the drain water. If hard items get into the dishwasher module, you may hear chopping noises during drain. These sounds are normal.
- Foods that have been burned onto cooking utensils will need to be scraped or soaked.
- Certain foods, such as mustard, mayonnaise, lemon juice, vinegar, salt or dressings may cause stainless steel flatware to rust and pit if allowed to remain in contact with the surface for a period of time. Therefore, it is best to rinse these food soils off stainless steel flatware unless the dishwasher is to be operated soon after loading.
- If your dishwasher drains into a food waste disposer, make certain the disposer is completely empty before starting the dishwasher to provide for proper draining.

### Loading Your Dishwasher

Seldom will households have identical dishes; the number and type of articles used will vary daily. Your dishwasher is designed to be flexible and accommodate a wide variety of dishes and utensils. The following instructions and pictures will help you become familiar with your dishwasher. With experience, you will learn the best arrangement for your particular needs.

### General Recommendations

- Place all items on racks so they are separated and face the center to insure the water spray will reach the soiled surfaces. Do not allow items to extend out of the racks.
- Make sure the movement of the upper and lower spray arms is not blocked by items hanging below the lower rack or tall articles in the upper rack.
- Insure the free flow of water to the detergent cup by not blocking it with large items.
- Larger, flat, lightweight items (such as plastic covers) may be wedged next to the silverware basket or along the sides and back of the racks.
- The wash tower rises through the center of the lower rack during the cycle. For the best cleaning results, avoid blocking it or loading tall articles next to it.

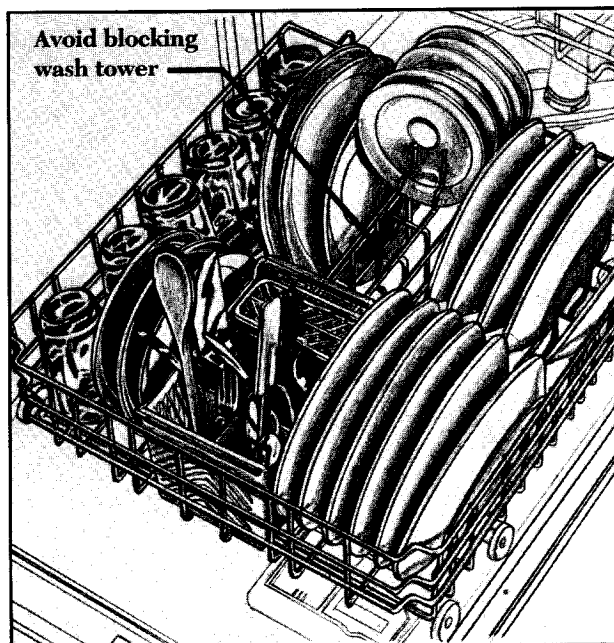

## Upper Rack

The upper rack of your dishwasher is designed with flexibility in mind. Glasses, cups, small plates, bowls, pans, etc. can be loaded in many different positions to suit your needs.

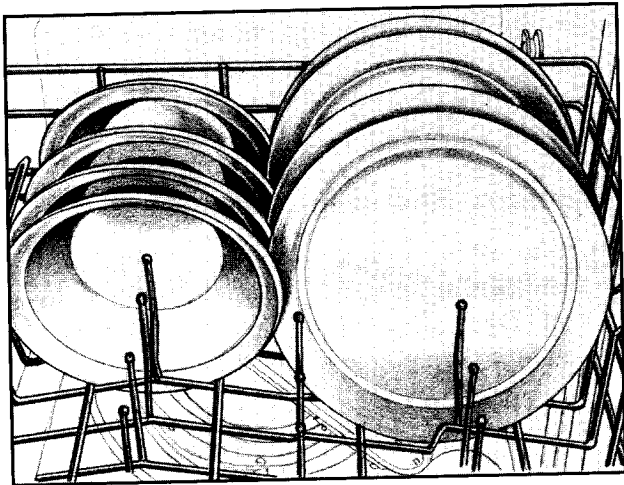

The rack is designed so dishes can be centered behind a single tine and held in place by the rack's support wires. Dishes can also be loaded at an angle to maximize space.

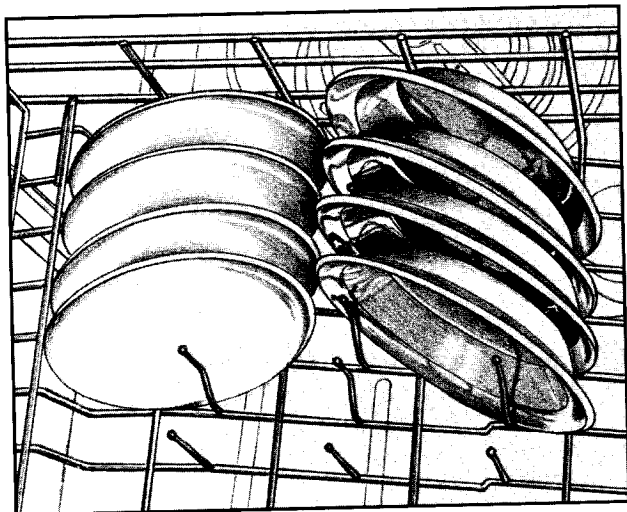

When loading glassware, leave a small space between each piece so they do not touch each other during the wash cycle. **Do not place glasses over the tines.**

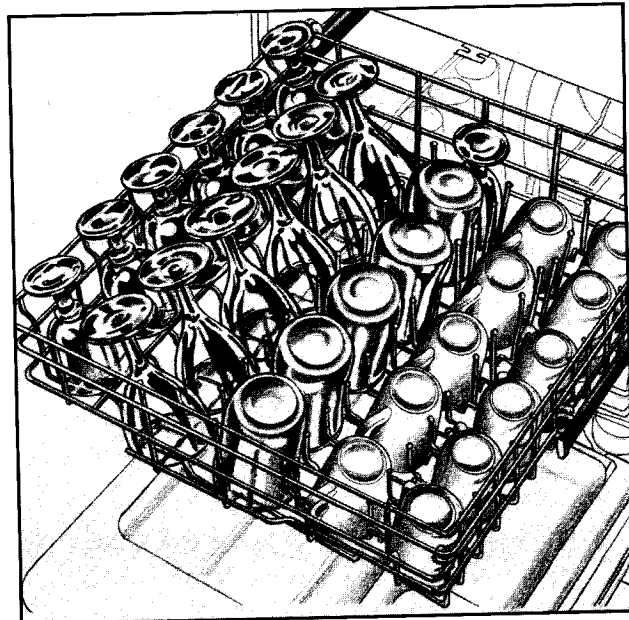
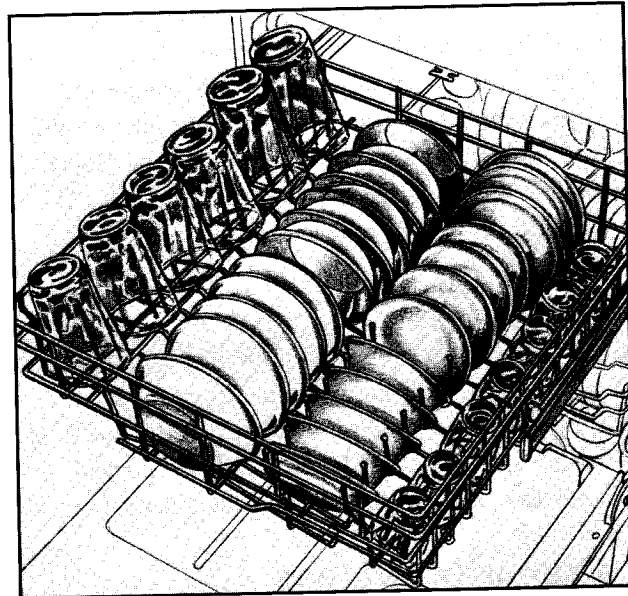

The upper rack may be removed if desired. Push inward on the front of the rack rail ends to unsnap. Remove rail ends and pull out rack.

To replace rack: reinsert rack, place rail ends in position and snap fronts into place by pushing outward.

## Lower Rack

Large dinner plates and other dishes may be placed in any convenient location in the lower rack but **soiled surfaces should face the center.**

Tall items such as bakeware and large platters should be loaded on the left side of this rack.

Small items such as plates, saucers or shallow bowls may be loaded in the elevated area behind the wash tower.

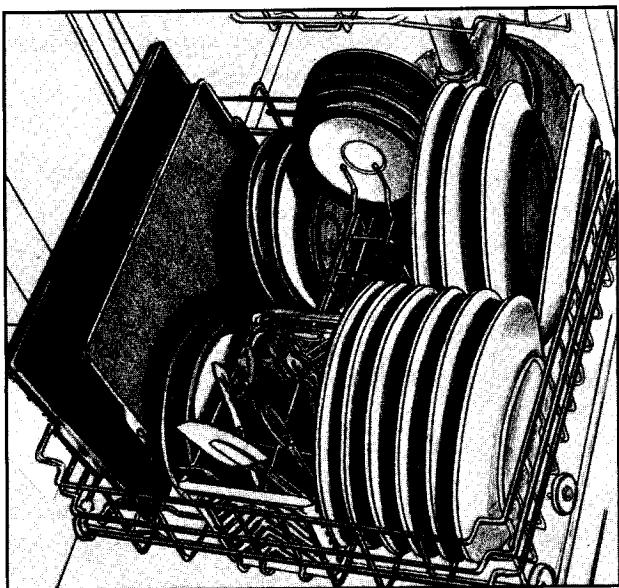

The convertible bowl tines in the right rear corner can be folded to provide either narrow or wide spacing. This allows flexible loading of a variety of articles such as serving bowls, plates, pans or casserole dishes.

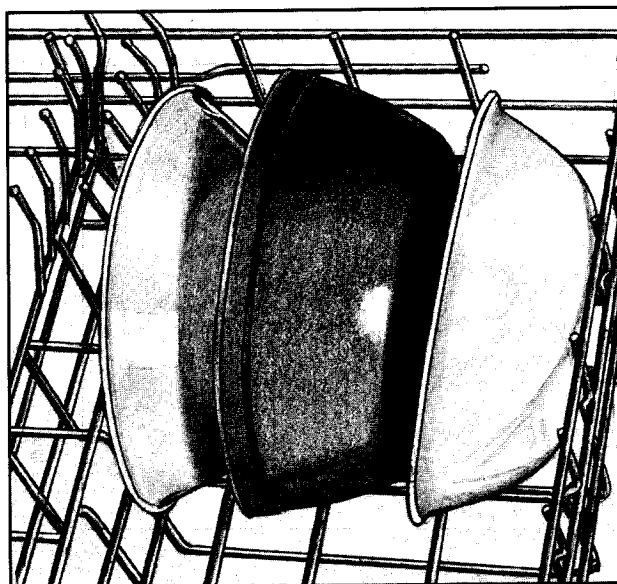
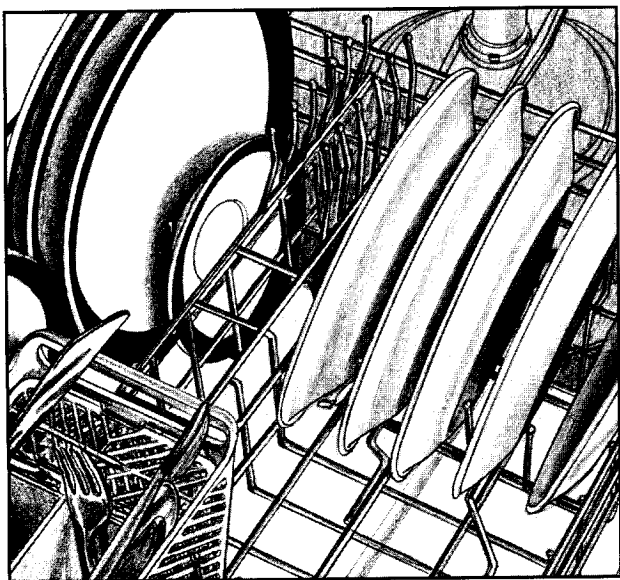

## Flatware

Put flatware in the removable silverware basket, mixing knives, forks and spoons. To prevent them from nesting together, place some handles up and some down. However, sharp or pointed items should be loaded with the handles up.

The silverware basket may be removed for ease of loading or unloading.

Use the covered section for small, lightweight articles such as measuring cups and spoons, small plastic items, baby spoons, etc. Lower the cover to keep these items in place.

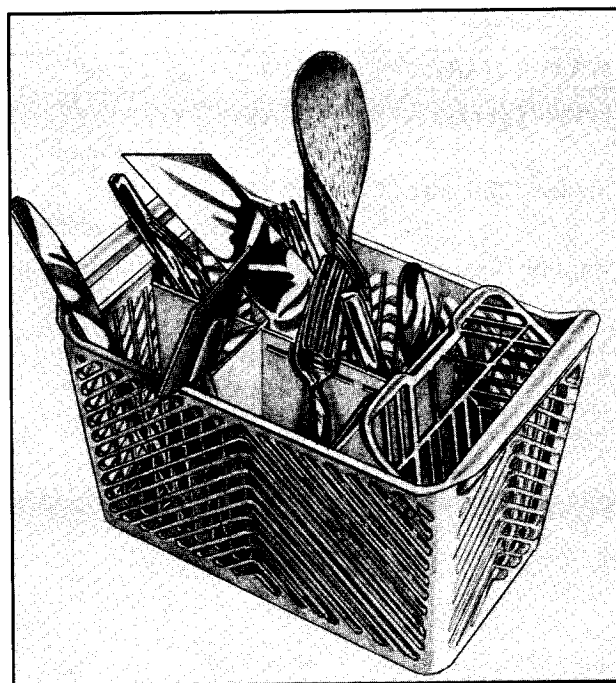

## Using Detergent and Rinse Aid

### Detergent

Use only a powder or liquid detergent designed for an automatic dishwasher. Never use soap, laundry detergent or hand dish washing detergent in your dishwasher as it will cause severe oversudsing. Use fresh detergent and store it in a cool, dry place (not under kitchen sink).

### Recommended Amount to Use

The amount of detergent to use depends on the water hardness (measured in grains per gallon—gpg) and the amount of soil on the dishes. Generally detergent amounts should be increased for harder water and heavier soil.

Too little detergent can result in poor cleaning, hard water filming and spotting, and poor drying. Overuse of detergent (especially in chemically softened water) can cause permanent etching (cloudiness) of glassware. For detergents with low phosphate content (8.7% or less) the usage level may have to be increased. The phosphate content is shown on the side of the box.

A basic guideline is one teaspoon of detergent for each grain of water hardness (gpg). Use a minimum of three teaspoons (one tablespoon) in soft water. Refer to the chart below.

WATER HARDNESS*	DETERGENT USE
Soft (0-4 grains)	1-2 Tbs. (fill cup to first line)
Medium (5-8 grains)	2-3 Tbs. (fill cup to second line)
Hard (9-12 grains)	3-4 Tbs. (fill cup to third line)

\*Your local water utility can tell you the exact degree of hardness of your water supply. In rural areas, your state university extension service can tell you how to test your water hardness.

For water hardness over 12 grains, add additional detergent (1 teaspoon for each grain over 12) at the beginning of the main wash portion of the cycle. (Open door, add detergent to bottom of tub, close door and dishwasher will continue through cycle.)

If water is 15 grains or harder, it will be virtually impossible to get good results with *any* dishwasher. The only solution is a mechanical water softener to improve water quality.

### Adding Detergent

*Add Detergent to Dispenser Cup Just Before You Select the Cycle and Options.*

#### Normal Cycle or Pots & Pans

Place proper amount of detergent in both the Prewash and Main Wash cups. Close the lid. Detergent will be released automatically into the prewash and main wash.

#### Light/China

Place the proper amount of detergent in the Main Wash cup only. Close the lid. The detergent will be released automatically into the main wash.

#### Rinse & Hold

Do NOT use detergent in this cycle.

## Rinse Aid

Your Maytag dishwasher features an automatic rinse aid dispenser, located near the detergent dispenser on the door interior. Using a rinse aid improves drying results and reduces spotting and filming.

To fill, turn dispenser cap counterclockwise to open. Remove cap and pour liquid rinse additive into the opening. Replace cap and turn clockwise to close.

The clear indicator in the center of the cap changes from dark to light when the reservoir is nearly empty. This indicates that it is time to refill the dispenser.

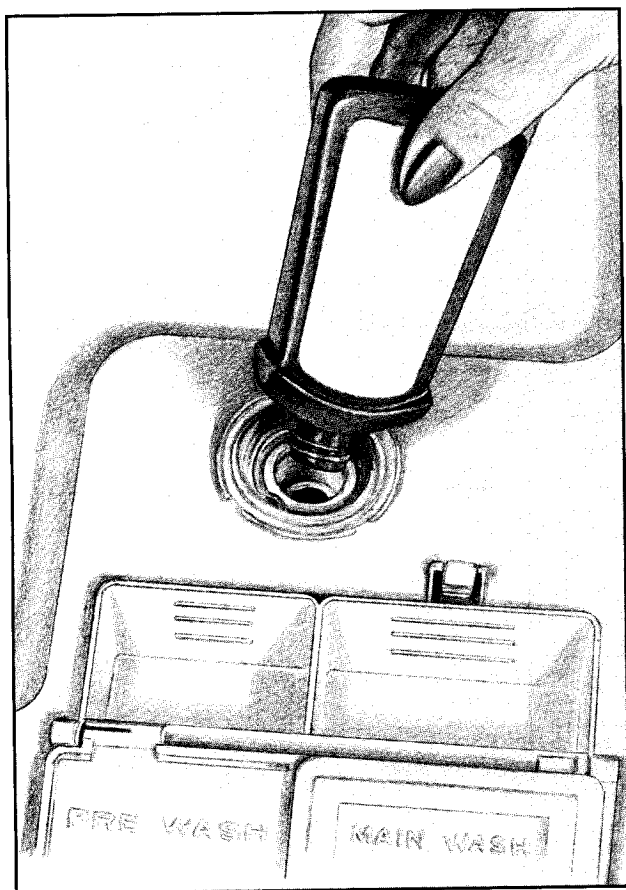

## Connecting a Convertible Dishwasher

Turn on the hot water faucet and allow water to run until water coming from the faucet is hot. Shut off.

Pull faucet connector from recess in back of dishwasher as shown.

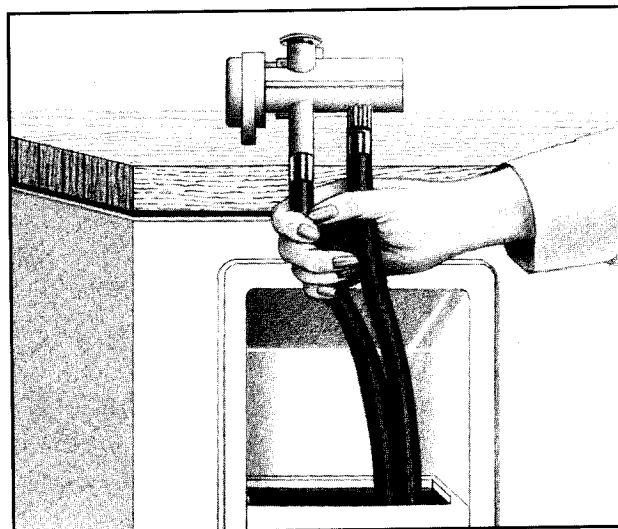

Press down on thumb release. Lift connector up on to faucet and remove pressure from thumb release to hold connector firmly in place.

Turn on hot water faucet full force.

Be sure the sink drain is open so that water from the dishwasher will properly drain.

Pull electric cord from the back of the dishwasher and plug into a properly grounded electrical outlet.

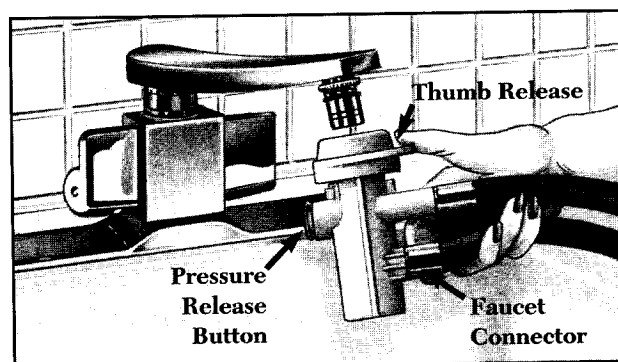

## Caring for the Wood Top

Before using a convertible dishwasher for the first time, wipe the wood top with a damp cloth to remove surface dust and then dry. Saturate cloth with mineral oil and apply a heavy coat to the wood top. Let stand overnight. The next day apply a thin coat of mineral oil and rub with a soft dry cloth. Repeat every few months to maintain the appearance of the wood top.



# SELECTING CYCLES AND OPTIONS/STARTING DISHWASHER

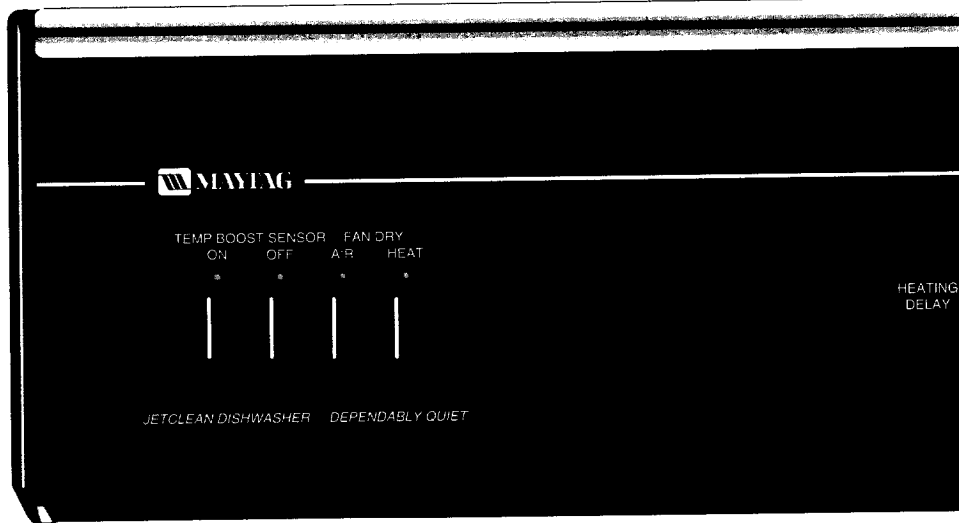

CYCLE SETTING	SEQUENCE	APPROX. CYCLE TIME	WATER USE							
<p><b>RINSE &amp; HOLD:</b> Use to rinse a relatively few soiled dishes which are to be held until the dishwasher is full. Turn knob to Rinse &amp; Hold.</p>	Rinse	7 Min.	2 Gal.							
<p><b>LIGHT/CHINA:</b> Use for china and crystal and for loads containing medium to light amounts of soil. Turn knob to Light/China.</p>	<table border="1"> <tr><td>Rinse</td><td rowspan="4"> </td><td rowspan="4">41 Min.</td></tr> <tr><td>Main Wash</td></tr> <tr><td>2 Rinses</td></tr> <tr><td>Dry</td></tr> </table>	Rinse		41 Min.	Main Wash	2 Rinses	Dry	<p>41 Min.</p> <p><u>35 Min.</u></p> <p>76 Min. + Heating Delay*</p>	7 Gal.	
Rinse		41 Min.								
Main Wash										
2 Rinses										
Dry										
<p><b>NORMAL CYCLE:</b> Use for washing loads containing normally soiled dishes. This would include dishloads with problem soils. Turn knob to Normal Cycle.</p>	<table border="1"> <tr><td>PreWash</td><td rowspan="5"> </td><td rowspan="5">49 Min.</td></tr> <tr><td>Rinse</td></tr> <tr><td>Main Wash</td></tr> <tr><td>2 Rinses</td></tr> <tr><td>Dry</td></tr> </table>	PreWash		49 Min.	Rinse	Main Wash	2 Rinses	Dry	<p>49 Min.</p> <p><u>35 Min.</u></p> <p>84 Min. + Heating Delay*</p>	9 Gal.
PreWash		49 Min.								
Rinse										
Main Wash										
2 Rinses										
Dry										
<p><b>POTS &amp; PANS:</b> Use for loads with heavy or dried soils. Turn knob to Pots &amp; Pans.</p>	<table border="1"> <tr><td>PreWash</td><td rowspan="5"> </td><td rowspan="5">64 Min.</td></tr> <tr><td>2 Rinses</td></tr> <tr><td>Main Wash</td></tr> <tr><td>2 Rinses</td></tr> <tr><td>Dry</td></tr> </table>	PreWash		64 Min.	2 Rinses	Main Wash	2 Rinses	Dry	<p>64 Min.</p> <p><u>35 Min.</u></p> <p>99 Min. + Heating Delay*</p>	11 Gal.
PreWash		64 Min.								
2 Rinses										
Main Wash										
2 Rinses										
Dry										

\*The TEMP BOOST SENSOR may extend the main wash to heat the water to proper temperature. The HEATING DELAY indicator will light when the cycle is being extended due to low water temperatures.

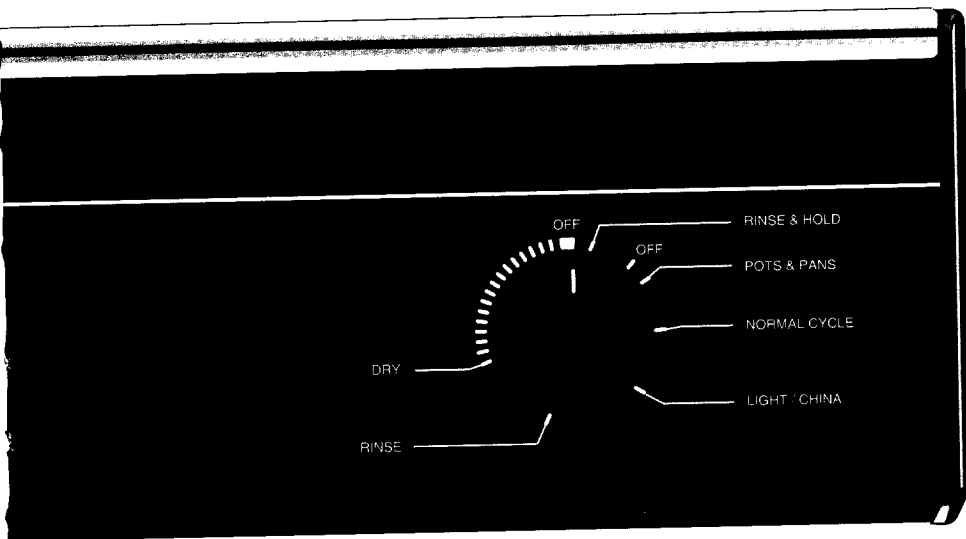

## Options:

### Temp Boost Sensor:

If for any reason the incoming water temperature is below 120°F, press the On button to assure the water is heated to proper temperature for best cleaning and drying results. The main wash will be extended and the Heating Delay light will turn on.

Press the Off button to cancel the Temp Boost Sensor.

### Fan Dry Options:

Press the Heat button to turn the heating element on during the fan dry period. This option provides faster drying.

Press the Air button to turn the heating element off during the fan dry period.

### To Start Dishwasher:

After loading set the dial to the desired cycle. Press button for desired options.

*NOTE:* Run the water from the hot water tap to clear the line of cold water before starting.

Press the door until it latches. The cycle will begin with a drain prior to fill.

### Indicator Light:

The Heating Delay light indicates that the main wash is being extended to heat the water to proper temperature.

### Adding a Forgotten Item:

For best cleaning, the forgotten item should be added early in the cycle.

1. Unlatch the door and wait until the sound of circulating water stops.
2. Open the door and add the item.
3. Pause before latching the door. The cycle will continue at the point it was interrupted.

## SPECIAL TIPS

### For Best Results

- Hot Water is a Must

Hot water dissolves and activates the dishwashing detergent, dissolves grease on dishes and helps dry glasses spot-free. Make certain all loads are washed in hot water. Three ways to have a reliable hot water supply. . .

1. Maintain a minimum 120°F (49°C) water supply at the central water heater. To check water temperature, refer to page 3.
2. If your hot water is below 120°F (49°C), it will be necessary to select Temp Boost Sensor On to achieve good results. The Temp Boost Sensor will add heat during the main wash and thermostatically check the water temperature. If the proper temperature is not reached during the standard main wash time, the Heating Delay light will come on and the cycle will be delayed until the temperature is reached.
3. Let the water from the hot water tap run to clear the line of cold water before selecting a cycle.

- Use Enough Detergent

For proper soil removal and to prevent filming, etching and spotting, an adequate amount of detergent must be used. We recommend 1 teaspoon of detergent per grain of water hardness with a minimum of 1 tablespoon. Refer to page 6 on adding detergent.

- Use a Rinse Aid

Using a rinse aid improves drying results and reduces spotting and filming. See page 7 for instructions on using a rinse aid.

- Load the Dishwasher Properly

To insure that all soiled surfaces get adequate wash action, carefully follow the instructions for loading the dishwasher (pages 3–5). Make sure nothing extends above or below the racks

to interfere with the movement of the upper or lower spray arms.

- Select the Proper Cycle

The cycle needed depends on the amount of food soil. See page 8 for cycle descriptions.

- Select Heat Dry

For faster drying select Heat Dry.

### Water Conditions

- Hard Water Deposit

If an unusual amount of calcium is in the water, a lime film or deposit may eventually build up on the dishes and interior surface of dishwasher. You may first notice this as “cloudy” glasses.

**To determine if the film on the glasses is due to hard water, soak a glass approximately 15 minutes in undiluted white vinegar. Rinse and dry. If film is removed, it is due to hard water (if not removed, see Soft Water Etching).**

To correct:

1. Increase the amount of detergent used according to the degree of water hardness (see page 6).
2. Check the water temperature (see page 3).
3. Use a rinse aid to improve the sheeting action of the water (see page 7).

To remove film from dishwasher interior, try **one** of the following:

1. Remove with a damp cloth and a mild scouring powder.
2. Start empty dishwasher on Rinse & Hold cycle. During fill, open door and add 1/2 cup white vinegar to water. Allow dishwasher to complete cycle. Do not use detergent. Follow with a regular detergent wash.
3. Use Lime-A-Way according to manufacturer's directions.

- **Soft Water Etching**

If the cloudy film is not removed after soaking in vinegar (previous procedure), then the condition is etching. This permanent film occurs in unusual conditions under which the surface of the glass is pitted or eroded. It is permanent.

In the beginning stages, etching may be identified by a "rainbow" look—shades of blue, purple, brown or pink may be seen when the glass is held at an angle to the light. In advanced stages the surface of the glassware appears frosted, spotted or cloudy.

Certain types of glassware will etch in any dishwasher with the combination of soft water (especially mechanically softened), an excessive amount of detergent, heat and prerinsing. There is no relationship to the cost or quality of the glass.

To prevent:

1. Adjust the amount of detergent to the degree of water hardness (see page 6).
2. Lower the water temperature (see page 3).
3. Avoid using the Heat Dry drying option.
4. Do not manually prerinse dishes before loading in dishwasher. Prerinsing prior to loading to remove all food soil aggravates etching.

- **Rust**

Sometimes the dishes or the interior of the dishwasher may turn a brown, red or black color if iron or manganese is in the water. To remove discoloration from dishwasher interior, dishes and glassware (no metal items):

1. Select a rust removing compound, such as RoVer Rust Remover. It is available from Maytag Parts Distributors by using Part No. 57961.

2. Start empty dishwasher on Rinse & Hold or rinse portion of the cycle. During fill, open the door and add 1/2 cup RoVer Rust Remover to the water. Allow the dishwasher to complete the cycle.

3. Follow with a detergent wash.

The only permanent solution is to install special filters which can remove iron and manganese from the water.

## **Energy Saving Tips**

You can help save energy if you:

1. Wash full loads. Running a half-filled dishwasher uses the same amount of electricity and hot water as a fully loaded machine.
2. Do not pre-rinse normally soiled dishes. Select the correct cycle for the load and use the recommended amount of detergent for good washing results without hand rinsing.
3. Load correctly for best washing results. Incorrect loading may cause poor washing and the need to prewash all or part of the load.
4. Use the Light/China cycle when dishes are lightly soiled. It uses less hot water and energy than other cycles.
5. Fan dry dishes (without heat) when you don't need a rapid drying cycle. Allow longer drying times (overnight).
6. Use your dishwasher during off-peak hours. Local utilities recommend this to avoid heavy usage of energy at certain times of day. Check with your utility company to see if off-peak rates exist.

## What Can and Cannot Be Washed in Your Dishwasher

Most tableware, cookware and silverware can be safely washed in your Maytag dishwasher. If you have any doubts about a particular piece of dishware, check with the manufacturer to see if it is dishwasher safe. If you cannot reach the

manufacturer, simply test-wash a small item for several weeks before attempting to wash an entire set.

*REMEMBER: It is the user's responsibility to determine if dishware should be washed in a dishwasher.*

Material	Dishwasher Safe?	Special Information	Material	Dishwasher Safe?	Special Information
<b>Aluminum</b>	Yes, except anodized aluminum and some cookware.	High water temperature and detergents may affect finish. Check cleaning instructions.	<b>Pewter</b>	No	High water temperatures and detergent may discolor or pit finish.
<b>Cast Iron</b>	No	Seasoning will be removed, and iron will rust.	<b>Disposable Plastics</b>	No	Cannot withstand high water temperatures and detergents.
<b>China/ Stoneware</b>	Yes, except antique or hand-painted china.	Always check manufacturer's recommendation before washing. Antique hand-painted or over-the-glaze patterns may fade. Gold leaf may discolor. If in doubt, test-wash a small item for several weeks before washing an entire set.	<b>Plastics</b>	Yes (If labeled "dishwasher safe")	Always check manufacturer's recommendation before washing. Plastics vary in their capacity to withstand high water temperatures and detergents.
<b>Crystal</b>	Yes, except antique or lightweight delicate crystal.	Always check manufacturer's recommendation before washing. Some types of leaded crystal may etch with repeated washings. If in doubt, test-wash a small item for several weeks before washing an entire set.	<b>Stainless Steel</b>	Yes	Run a Rinse & Hold Cycle (select models) if not washing immediately. Prolonged contact with foods containing salt, vinegar, milk products or fruit juice could damage finish.
<b>Glass</b>	Yes, except milkglass.	Milkglass will yellow with repeated dishwasher washing.	<b>Sterling Silver or Silverplate</b>	Yes, except those with commercial "darkening".	Run a Rinse & Hold Cycle (select models) if not washing immediately. Prolonged contact with food containing salt, acid or sulfide (eggs, mayonnaise and seafood) could damage finish. Commercial "darkening" may be removed by detergent.
<b>Gold-Plated Flatware</b>	No	Will discolor.	<b>Tin</b>	No	May rust.
<b>Hollow-Handle Knives</b>	No	Handles may be attached to the blade with adhesives which may loosen if dishwasher washed.	<b>Wooden Items</b>	No	Always check manufacturer's recommendation before washing. Wood may warp, crack or discolor.

## Caring For Dishwasher

The interior is normally self-cleaning. Occasionally check the bottom of the dishwasher tub and clean out pieces of food which may collect there.

Periodically clean the bottom edge of the dishwasher door liner. Food and liquids drip onto this area when the dishwasher is loaded.

If you notice an odor in your dishwasher, it may be due to a strong "chemical" or chlorine odor from the dishwasher detergent. Using a different detergent, especially a lemon scented one, will probably eliminate the odor. In some instances the smell of the rinse additive may be strong. Purchase a fresh package and see if it is better. Lastly, if the dishwasher is run only every couple of days, an odor may develop. Use the Rinse & Hold feature daily to remove any food soil that may cause an odor.

To remove an odor, try one of the following:

1. Place baking soda in both sides of the detergent dispenser. Select Light/China and let the water circulate for about 10 minutes. Stop the dishwasher by unlatching the door and let stand overnight. Then, restart the dishwasher by latching the door and let it complete the cycle.
2. Select the Light/China cycle and let the dishwasher fill with water. Then open the door and pour one cup of chlorine bleach into the bottom of the dishwasher. Latch the door and let the dishwasher complete the cycle.

Clean the control panel and front panel with a soft damp cloth and liquid spray cleaner. Do not use any abrasive powders or cleaning pads.

## Changing Panels

Your Maytag dishwasher comes with reversible panel inserts which are pre-assembled at the factory. This enables you to select the color you want before your dishwasher is installed or choose another color at a later date.

## To Change Panels:

- A. Remove three screws holding the metal trim strip on one side of the door. Take note of how the trim comes off.
- B. Grasping the lower part of the door panels, bow panels out carefully at the bottom while sliding panels far enough to clear the flange on the trim strip which was not removed and remove panels.
- C. Arrange panels so the desired color is facing out.
- D. Place door panels (notched side up) behind the metal trim at the bottom of the door. Bow the panels so they fit behind the control panel at the top.
- E. Slide the panels under the side metal trim which was not removed. To do this, it will be necessary to compress the backing behind the colored panels.
- F. Reinstall the metal trim which was removed earlier. To do this, start by inserting the tip end of the trim strip behind the control panel. Align the holes and replace the three screws.
- G. The lower access panel is held by four screws (two above the panel and two below). With these removed, the panel may be removed to make it easy to change panel colors.
- H. With the lower access panel removed, remove the four screws along the bottom of panel and remove the trim which holds the panels. Once the desired panel is facing out, replace the trim, and reinstall the panel to the dishwasher.

Use care when changing panels to be certain you are not injured on sharp edges and that the panels are not damaged. If you have any questions concerning changing panels, contact your local Maytag Dealer.

## BEFORE YOU CALL FOR SERVICE

### Check these points if your dishwasher. . .

#### *Leaves food soil on dishes*

- Check to see that the water heater is set to deliver at least 120°F water at the faucet.
- Turn on hot water at kitchen sink before running the dishwasher to be certain that hot water is entering the first wash cycle.
- Select Temp Boost option if available.
- Check water hardness. For extreme hard water conditions it may be necessary to install a mechanical water softener.
- Use the amount of detergent recommended for your water hardness, and be sure it is put in the dispenser as directed previously.
- Use fresh high phosphate detergent that is not caked. Store detergent in cool, dry place.
- Select proper cycle for soil level of dish load.
- Be sure dishes are loaded properly with nothing blocking the path of the wash arms, center spray nozzle or detergent dispenser.
- Check for nesting of dishes that prevents water from reaching all surfaces.
- Check to make sure glasses are not loaded over prongs.
- On convertible models make certain the hot water faucet is turned on.

#### *Leaves glassware cloudy or spotted*

- Adjust the detergent amount to your water hardness as described earlier in this book. Avoid overuse or underuse of detergent.
- Check to see that the water heater is set to deliver at least 120°F water at the faucet nearest the dishwasher. Avoid extremely high or low temperatures.
- Use a rinse agent such as Jet-Dry.
- Do not pre-rinse dishes before loading them into the dishwasher.
- Refer to Water Conditions for more information.

### *Does not dry properly*

- Be sure the Heat Dry option is selected.
- Use a rinse agent such as Jet-Dry.
- Check to see that the water heater is set to deliver at least 120°F water at the faucet nearest the dishwasher. Run water and check temperature with a candy thermometer.
- Select Temp Boost and Sani Rinse options if available.
- Increase detergent use according to water hardness.
- Check for improper loading and do not overload. Dishes should not nest together.
- Plastic items have a porous surface and tend to hold water. Towel drying may be required.
- Glasses, cups, etc., with concave bottoms will hold water.
- When using Quick Cycle (select models), towel drying is required.

### *Stains or discolors dishes*

- Aluminum utensils can leave marks when they rub against other things. Load properly.
- Iron deposits in the water can leave a yellow or brown film on dishes. You may desire to have a special filter installed in the water supply line, or periodically use RoVer Rust Remover (see Water Conditions).

### *Cycle takes too long - (Heating Delay light stays on)*

- Temp Boost option has been selected which will extend the cycle to heat water thermostatically.
- Check to see that the water heater is set to deliver at least 120°F water.

### *"Clean" light remains on (select models)*

- On timer models turn dial slightly clockwise until light shuts off.
- On touch control models Clean stays lit until the door has been open longer than 30 seconds.

## BEFORE YOU CALL FOR SERVICE

(continued)

### **Seems noisy**

- Water circulation noise is normal.
- Humming during drain is normal.
- Dishes may not be loaded properly. Dishes should not be touching one another.
- Wash arm may be hitting an item when rotating. Load items so nothing blocks the wash arm.
- Chopping or grinding noise may be heard during drain when the internal food disposer is chopping hard items such as fruit seeds, nuts, etc.
- Detergent cup lid hits door liner when dishwasher door is opened at end of cycle and is normal.
- Installation (location, flooring, cabinetry, etc.) can affect noise level.
- Water valve hiss during fill is normal.

### **Does not run properly/Won't fill**

- Be sure door is tightly closed and latched.
- Check to see that water is turned on.
- The cycle is not properly selected. Be sure the dial is turned far enough or the cycle pad is completely depressed.
- Cycle will start with drain.
- Check your home's circuit breaker or fuse box.
- Inlet hose may be kinked.
- Water inlet valve may be clogged with sediment and in need of cleaning.

### **Does not drain properly**

- Check to see that the cycle has been completed.
- The dishwasher may be at a pause between cycles which is normal.
- Drain hose may be kinked.
- Check your home's circuit breaker or fuse box. Reset if necessary.
- Food is backing up in the pipes at the sink. If hooked up to a food waste disposer, be sure to run the disposer regularly.
- Some water is normal and keeps seals from drying.

### **Detergent cup did not empty completely**

- Check to see that the cycle has been completed.
- Be sure dispenser is not blocked from wash action.
- Be sure dispenser is not wet when detergent is added.
- Make sure large items placed in the front right corner of upper rack are not blocking the detergent cup.
- Use fresh detergent. Store in dry, cool place.

### **Leaks**

- Check to see that the dishwasher is level as described in the Installation Instructions.
- Suds can cause the unit to overflow so measure detergent carefully. Try another brand of detergent. Use only detergents designed for automatic dishwashers.
- Make sure you follow directions on how to add a forgotten item.

### **Has an odor**

- Soiled dishes held too long in the dishwasher can create an odor, therefore we recommend using the Rinse & Hold cycle if available.
- Dishwashers will have a "new" smell when first installed.
- Dishwasher not draining properly. (See "Does not drain properly")

### **Chips dishware**

- Be sure dishes are loaded according to the instructions so they do not strike together from the wash action.
- We do not recommend washing fine antique china and crystal in the dishwasher.
- Do not load glasses over rack tines, or allow to touch each other.
- Do not overload.

For further assistance contact your Maytag dealer or call Maytag Customer Assistance:

U.S.	1-800-688-9900
CANADA	1-800-688-2002



# DISHWASHER WARRANTY

## Full One Year Warranty

Any part which fails in normal home use during the first year after the date of original retail purchase, will be repaired or replaced free of charge.

## Limited Two Year Warranty

Any part which fails in normal home use during the second year from the date of original retail purchase, will be repaired or replaced free of charge for the part itself, with the owner paying all other costs, including labor.

## Limited Five Year Warranty on Jetclean System and Solid State Controls

Any parts of the Jetclean system including the complete power module assembly, center spray nozzle, spray arms, top wash arm hose, motor, AND—on Computer Touch Control Models only—any microprocessor and touch pad assemblies which fail in normal home use during the second through the fifth year from the date of original retail purchase, will be repaired or replaced free of charge for the part itself, with the owner paying all other costs, including labor.

## Limited Five Year Warranty Against Rust

Should any of the parts listed below rust during the five year period starting from the date of original retail purchase, repair or replacement will be made free of charge during the first year. After the first and through the fifth year, repair or replacement will be made free of charge for the part itself, with the owner paying all other costs, including labor. Parts covered by this warranty are the exterior cabinet and front panels of convertible models; the exterior front panels of built-in models, and Nylon coated racks (available on select models).

## FULL TWENTY Year Warranty Against Leaks on Dishwasher Tub and Door Liner

Should a water leak develop in the tub or door liner in normal home use during the TWENTY YEAR period starting from the date of original retail purchase, repair or replacement of the tub and/or door liner will be made FREE OF CHARGE.

These full warranties and the limited warranties apply when the appliance is located in the United States or Canada. Appliances located elsewhere are covered by the limited warranties only, which include parts which fail during the first year.

## Canadian Residents

This warranty covers only those appliances installed in Canada that have been listed with Canadian Standards Association unless the appliances are brought into Canada due to transfer of residence from the United States to Canada.

## TO RECEIVE WARRANTY SERVICE

**First:** To locate an authorized service company in your area, contact the Maytag dealer from whom your appliance was purchased or call Maytag Customer Assistance:

US 1-800-688-9900

CANADA 1-800-688-2002

or check in your telephone directory yellow pages.

**Second:** Should you not receive satisfactory warranty service from the dealer or authorized service firm, or need further assistance, call or write:

Maytag Customer Assistance  
c/o Maycor Appliance Parts and Service Co.

A division of Maytag Corporation

P.O. Box 2370

Cleveland, TN 37311

US 1-800-688-9900

CANADA 1-800-688-2002

When contacting Customer Assistance be sure to provide the model and serial number of your appliance, the name and address of the dealer from whom you purchased the appliance, and the date of purchase.

This Warranty gives you specific legal rights, and you may also have other rights which vary from state to state.

**Should you still have a problem,** write to: Major Appliance Consumer Action Panel, 20 North Wacker Drive, Chicago, Illinois 60606. MACAP is an industry sponsored but independent group of consumer experts who receive and act on complaints from appliance owners.

**NOTE:** When writing about an unsolved service problem, please include the following information:

- (a) Your name, address and telephone number;
- (b) Model number and serial number (found on the upper left corner of the tub opening) of your appliance;
- (c) Name and address of your dealer and date the appliance was bought;
- (d) A clear description of the problem you are having;
- (e) Water hardness, detergent brand and amount, water temperature, and cycle used.