

USER'S GUIDE

- Welcome 1
- Safety Instructions 1-3
- Range at a Glance 4
- Controls at a Glance 5-7
- Surface Cooking 8-10
 - Surface Controls 8
 - Coil Element Surface 9
 - Glass-Ceramic Surface 10
- Oven Operation 11-14
 - Baking and Roasting 11
 - Oven Vent and Light 12
 - Oven Racks 12
 - Broiling 13
 - Clock Controlled
Oven Cooking 14
- Care and Cleaning 15-18
 - Self-Clean Oven 15-16
 - Cleaning Chart 17-18
- Maintenance 19-20
- Before You Call for Service 21-22
- Warranty 23

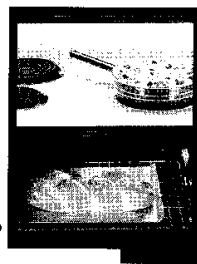

KEEP THESE INSTRUCTIONS FOR FUTURE REFERENCE

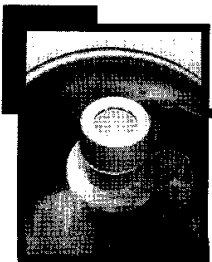

Welcome.....

Congratulations on your choice of a Maytag electric range. Your complete satisfaction is very important to us.

Read this user's guide carefully. It is intended to help you operate and maintain your new range.

In addition, you will find a booklet entitled "**Cooking Made Simple.**" It contains information on selecting cookware and provides baking, roasting and broiling tips.

Save time and money. Check the "Before You Call" section of this guide. It lists causes of minor operating problems that you can correct yourself.

However, should you need service, it is helpful to have the model and serial numbers available. This information can be found on the data plate located on the storage drawer frame.

These numbers are also on the Product Registration card that came with your appliance. Before sending in this card, record these numbers along with the purchase date below.

Model Number

Serial Number

Date of Purchase

IMPORTANT: *Keep this guide and the sales receipt in a safe place for future reference. Proof of original purchase date is needed for warranty service.*

If you have questions, write us (include your model number and phone number) or call:

Maytag Appliances Sales Company
 Attn: CAIRSM Center
 P.O. Box 2370
 Cleveland, TN 37320-2370
 1-800-688-9900 (USA)
 1-800-688-2002 (CANADA)
 1-800-688-2080 (U.S. TTY for deaf, hearing impaired or speech impaired)
 (Mon. - Fri., 8 am-8 pm Eastern Time)
 Internet: <http://www.maytag.com>

For service information, see page 22.

NOTE: In our continuing effort to improve the quality and performance of our cooking products, it may be necessary to make changes to the appliance without revising this guide.

Important Safety Instructions.....

Read and follow all instructions before using this appliance to prevent the potential risk of fire, electric shock, personal injury or damage to the appliance as a result of improper usage of the appliance. Use appliance only for its intended purpose as described in this guide.

To ensure proper and safe operation: Appliance must be properly installed and grounded by a qualified technician.

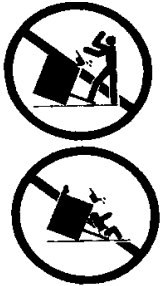
	<p style="text-align: center;">⚠ WARNING</p> <ul style="list-style-type: none"> • ALL RANGES CAN TIP AND CAUSE INJURIES TO PERSONS • INSTALL ANTI-TIP DEVICE PACKED WITH RANGE • FOLLOW ALL INSTALLATION INSTRUCTIONS
--	---

WARNING: To reduce risk of tipping of the appliance from abnormal usage or by excessive loading of the oven door, the appliance must be secure by a properly installed anti-tip device.

To check if device is properly installed, remove storage drawer and look underneath range to make sure one of the rear leveling legs is properly engaged in the bracket slot. The anti-tip device secures the rear leveling leg to the floor when properly engaged. You should check this **anytime** the range has been moved.

In Case of Fire

Turn off appliance and ventilating hood to avoid spreading the flame. Extinguish flame then turn on hood to remove smoke and odor.

- **Cooktop:** Smother fire or flame in a pan with a lid or cookie sheet. **NEVER** pick up or move a flaming pan.
- **Oven:** Smother fire or flame by closing the oven door



Do not use water on grease fires. Use baking soda, a dry chemical or foam-type extinguisher to smother fire or flame.

General Instructions

WARNING: NEVER use appliance door, or drawer, if equipped, as a step stool or seat as this may result in possible tipping of the appliance, damage to the appliance, and serious injuries.



If appliance is installed near a window, proper precautions should be taken to prevent curtains from blowing over surface elements.

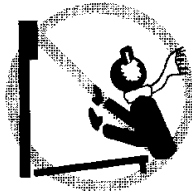

NEVER use appliance to warm or heat the room. Failure to follow this instruction can lead to possible burns, injury, fire, or damage to the appliance.



NEVER wear loose-fitting or hanging garments while using the appliance. Clothing could catch utensil handles or ignite and cause burns if garment comes in contact with hot heating elements.

To ensure proper operation and to avoid damage to the appliance or possible injury, do not adjust, service, repair or replace any part of the appliance unless specifically recommended in this guide. Refer all other servicing to a qualified technician.

NEVER store or use gasoline or other combustible or flammable materials in the oven, near surface units or in the vicinity of this appliance as fumes could create a fire hazard or an explosion.

To prevent grease fires, do not let cooking grease or other flammable materials accumulate in or near the appliance.

Use only dry potholders. Moist or damp potholders on hot surfaces may result in a steam burn. Do not let potholder touch hot heating elements. Do not use a towel or other bulky cloth which could easily touch hot heating elements and ignite.

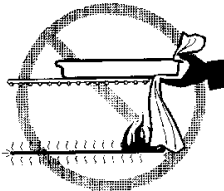

Always turn off all controls when cooking is completed.

NEVER heat unopened containers on the surface unit or in the oven. Pressure build-up in the container may cause container to burst resulting in burns, injury or damage to the appliance.

NEVER use aluminum foil to line drip bowls, or to cover an oven rack or oven bottom. Misuse could result in risk of electric shock, fire, or damage to the appliance. Use foil only as directed in this guide.

Cooktop

NEVER leave surface units unattended especially when using high heat settings. An unattended boilover could cause smoking and a greasy spillover can cause a fire.



This appliance is equipped with different size surface elements. Select pans having flat bottoms large enough to cover element. Proper relationship of pan to element will improve cooking efficiency.

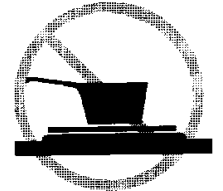

If pan is smaller than element, a portion of the element will be exposed to direct contact and could ignite clothing or potholder.

Only certain types of glass, glass/ceramic, ceramic, earthenware, or other glazed utensils are suitable for cooktop or oven service without breaking due to the sudden change in temperature. Follow utensil manufacturer's instructions when using glass.

Turn pan handle toward center of cooktop, not out into the room or over another surface element. This reduces the risk of burns, ignition of flammable materials, or spillage if pan is accidentally bumped or reached by small children.



To prevent damage to removable heating elements, do not immerse, soak or clean in a dishwasher or self-clean oven. A damaged element could short resulting in a fire or shock hazard.

Make sure drip bowls are in place as absence of these bowls during cooking could damage wiring.

Glass-Ceramic Cooktop (select models)

NEVER cook on broken cooktop. If cooktop should break, cleaning solutions and spillovers may penetrate the broken cooktop and create a risk of electric shock. Contact a qualified technician immediately.

Clean cooktop with caution. Some cleaners can produce noxious fumes if applied to a hot surface. If a wet sponge, cloth, or paper towel is used to wipe spills on a hot cooking area, be careful to avoid steam burn.

Deep Fat Fryers

Use extreme caution when moving the grease pan or disposing of hot grease. Allow grease to cool before attempting to move pan.

Safety Instructions (continued)

Oven

Use care when opening door. Let hot air or steam escape before removing or replacing food.

For proper oven operation and performance, do not block or obstruct oven vent duct.

Always place oven racks in desired locations while oven is cool. If rack must be moved while oven is hot, do not let potholder contact hot heating element in oven.

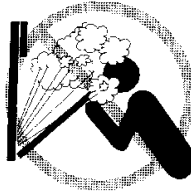

Self-Cleaning Oven

Clean only parts listed in this guide. Do not clean door gasket. The gasket is essential for a good seal. Care should be taken not to rub, damage, or move the gasket.

Do not use oven cleaners. No commercial oven cleaner or oven liner protective coating of any kind should be used in or around any part of the oven.

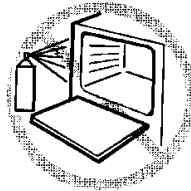

Before self-cleaning the oven, remove broiler pan, oven racks and other utensils to prevent excessive smoking, discoloration of the oven racks or possible damage to utensils.

Wipe up excessive spillovers, especially greasy spills, before the clean cycle to prevent smoking or flare-ups.

It is normal for the cooktop to become hot during a clean cycle. Therefore, avoid touching or lifting the cooktop during a clean cycle.

Heating Elements

NEVER touch surface or oven heating elements, areas near elements, or interior surfaces of oven.

Heating elements may be hot even though they are dark in color. Areas near surface elements and interior surfaces of an oven may become hot enough to cause burns. During and after use, do not touch or let clothing or other flammable materials contact heating elements, areas near elements, or interior surfaces of oven until they have had sufficient time to cool.

Other potentially hot surfaces include: Cooktop, areas facing the cooktop, oven vent, and surfaces near the vent opening, oven door, areas around the door and oven window.

Child Safety

NEVER leave children alone or unsupervised in area where appliance is in use or is still hot.

NEVER allow children to sit or stand on any part of the appliance as they could be injured or burned.

CAUTION: NEVER store items of interest to children in cabinets above an appliance or on backguard of a range. Children climbing on appliance, door or drawer to reach items could damage the appliance or be burned or seriously injured.

Children must be taught that the appliance and utensils in or on it can be hot. Let hot utensils cool in a safe place, out of reach of small children. Children should be taught that an appliance is not a toy. Children should not be allowed to play with controls or other parts of the unit.



Ventilating Hoods

Clean range hood and filters frequently to prevent grease or other flammable materials from accumulating on hood or filter and to avoid grease fires.

Turn the fan on when flambéing foods (such as Cherry Jubilee) under the hood.

Important Safety Notice and Warning

The California Safe Drinking Water and Toxic Enforcement Act of 1986 (Proposition 65) requires the Governor of California to publish a list of substances known to the State of California to cause cancer or reproductive harm, and requires businesses to warn customers of potential exposures to such substances.

Users of this appliance are hereby warned that when the oven is engaged in the self-clean cycle, there may be some low level exposure to some of the listed substances, including carbon monoxide. Exposure to these substances can be minimized by properly venting the oven to the outdoors during the self-clean cycle by opening a window and/or door in the room where the appliance is located.

Save These Instructions for Future Reference

Range at a Glance.....

ELECTRONIC CONTROL (pages 5-7)

OVEN LIGHT SWITCH (page 12)

BACKGUARD

SURFACE CONTROLS AND INDICATOR LIGHT (pages 8 & 9)

OVEN VENT (page 12)
• on glass-ceramic range
• on coil element range

HOT SURFACE INDICATORS
(glass-ceramic cooktop only, page 9)

SURFACE CONTROLS AND INDICATOR LIGHT
(pages 8 & 9)

DOOR LOCK LEVER
Select models (page 16)

SURFACE ELEMENTS
(pages 9 & 10)

BROIL ELEMENT
(not shown, page 13)

COOKTOP
(page 9 & 10)

RACK SUPPORTS

ANTI-TIP BRACKET
(page 20)

OVEN RACKS
(page 12)

LEVELING LEG
(page 20)

BAKE ELEMENT
(page 11)

DATA PLATE

OVEN WINDOW

STORAGE DRAWER
(page 20)

DOOR GASKET

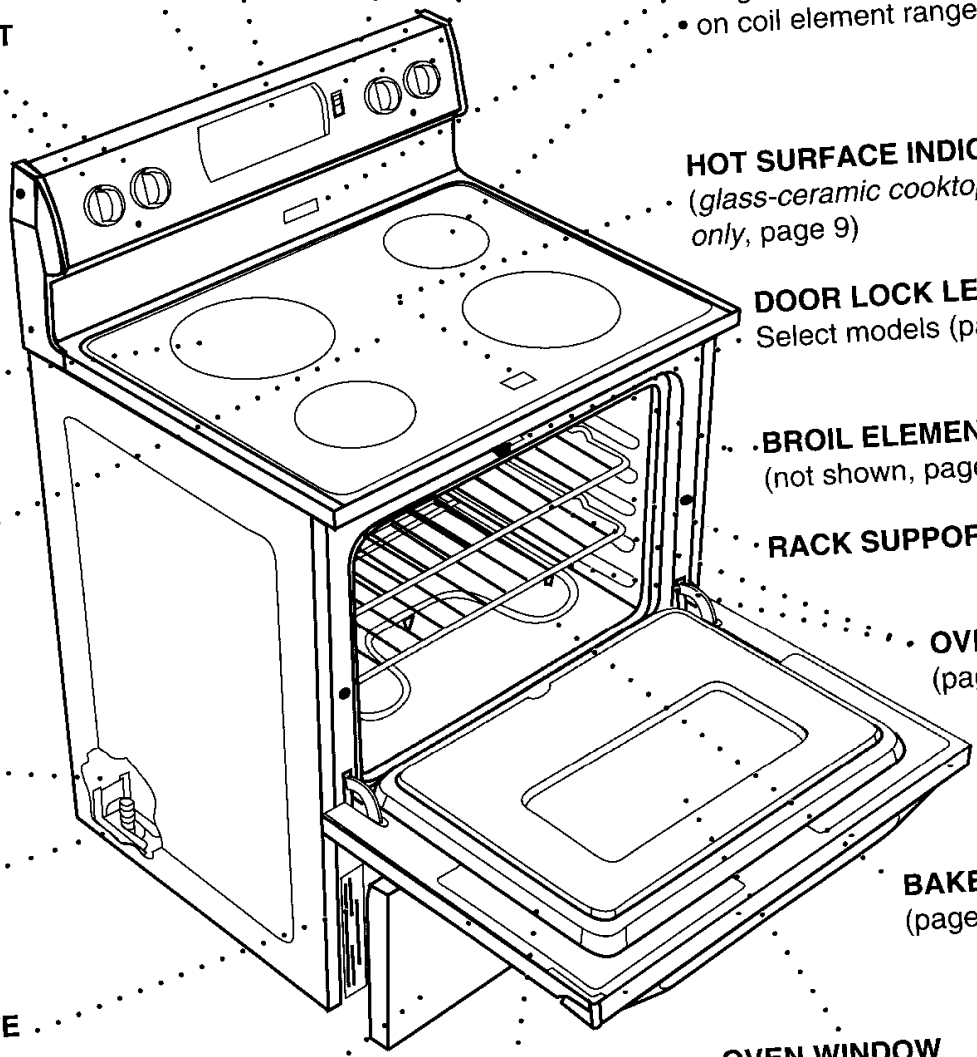

Controls at a Glance.....

The control panel is designed for ease in programming. The display window on the electronic control shows time of day, timer and oven temperatures.

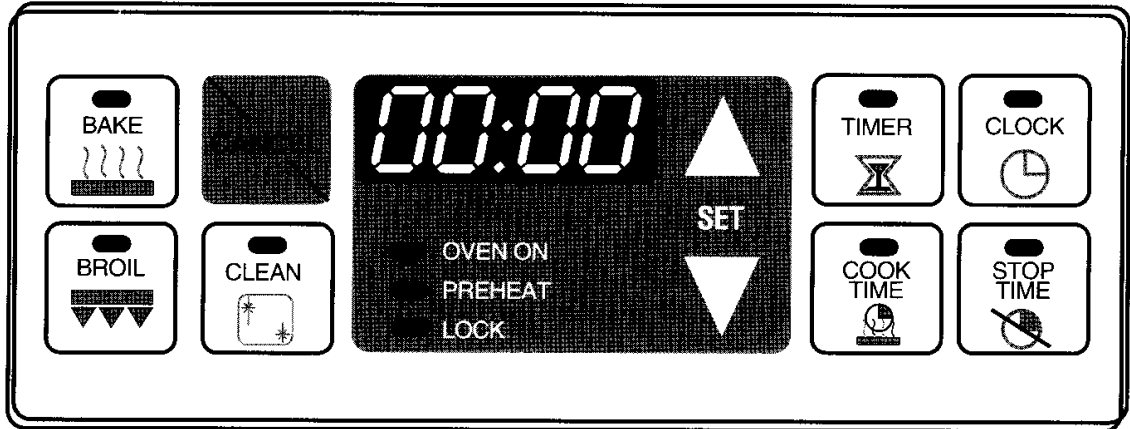

NOTE: Styling and features may differ slightly depending on the model.

Function Pads

- Press, or press and hold, these pads to enter time, oven temperature or to select HI or LO broil. No beep will sound when these pads are pressed.
- Press this pad to cancel all operations except the **TIMER** and **CLOCK**.
- Function pads are the **BAKE**, **BROIL**, **CLEAN**, **TIMER**, **CLOCK**, **COOK TIME**, **STOP TIME**, and **CANCEL** pads. A beep will sound when these pads are pressed.
- All function pads except the **CANCEL** pad feature an indicator light.

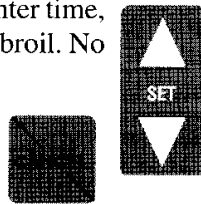

When **BAKE** or **BROIL** pad is pressed, the indicator light will turn on to let you know that the oven is set for this operation.

Indicator lights on **CLEAN**, **TIMER**, **CLOCK**, **COOK TIME** and **STOP TIME** pads will flash when the pad is pressed. These indicator lights will stop flashing but will remain lit once the function starts.



- If an indicator light on a function pad is lit and you set a second operation:
 - Either the control will not accept the operation or
 - The indicator light on the first pad will “dim” slightly and the indicator light on the pad you just pressed will be “full on.” This lets you know that you have set the control for two operations.

For example: If you set the oven to bake at 350°F and then set a timing operation, the indicator light on the **BAKE** pad will “dim” and the indicator light on the **TIMER** pad will be “full on.”



“Dim”

The display will show the operation for the pad with the “full on” indicator light. Press the function pad with the “dim” indicator light to recall that operation.



“Full On”

NOTE: If more than 30 seconds elapse between pressing a function pad and a ▲ or ▼ pad, the program will be canceled and the display will return to the previous display.

BAKE Pad

Use for baking or roasting.

1. Press **BAKE** pad.
2. Press ▲ or ▼ pad until the correct oven temperature appears in the display.

See page 11 for additional information.

BROIL Pad

Use for top browning and broiling.

1. Press **BROIL** pad.
2. Press ▲ or ▼ pad for HI or LO broil.

See page 13 for additional information.

CLEAN Pad

Use to set self-clean cycle.

For models with a manual door lock:

1. Close and lock oven door.
2. Press **CLEAN** pad. "3:00" will appear in the display.
3. Oven will automatically clean for 3 hours or press ▲ or ▼ pad to select 2 to 4 hours of cleaning.

For models with an automatic door lock:

1. Press **CLEAN** pad. "--:--" will appear in the display.
2. Press ▲ or ▼ pad. "3:00" hours of cleaning time will automatically be entered.
3. If more or less cleaning time is desired, press ▲ or ▼ pad to select times between 2 to 4 hours.

See pages 15-16 for additional information.

COOK TIME/STOP TIME Pads

Use to program the oven to start and stop automatically.

1. Press **COOK TIME** pad and enter the desired cooking time.
2. Press the **BAKE** pad and enter oven temperature.
3. To delay the start of cooking, press the **STOP TIME** pad and enter the time you wish the oven to turn off.

See page 14 for additional information.

Setting the Clock

1. Press **CLOCK** pad.
2. Press or press and hold ▲ or ▼ pad until the correct time of day appears in the display.

The display will flash when electrical power is first supplied to the range or if there has been a power failure.

To recall the time of day when another function is displayed, press the **CLOCK** pad.

Clock time cannot be changed when the oven has been programmed for clock controlled cooking, self-clean or delayed self-clean.

Setting the Timer

The timer can be set from one minute (0:01) up to 9 hours and 50 minutes (9:50).

The timer can be used independently of any other oven activity and it can be set while another oven function is operating. **THE TIMER DOES NOT CONTROL THE OVEN.**

1. Press the **TIMER** pad.
2. Press or press and hold the ▲ or ▼ pad until the correct time appears in the display.
 - The timer will start automatically. The **TIMER** indicator on the **TIMER** pad will light whenever the timer is in use.
 - One long beep and "End" will be briefly displayed to signal the end of the timer operation.

To cancel timer: Press and hold **TIMER** pad for three seconds. Time of day will reappear in the display.

Control Options

Clock Controlled Oven Cooking Beep Option

Option 1. (default option) Four beeps at the end of cooking, then, one beep every 30 seconds for the next five minutes or until the **CANCEL** pad is pressed.

Option 2. Four beeps at the end of cooking, then, no other beeps.

Option 3. Four beeps at the end of cooking, then, one beep every minute for the next 12 hours or until the **CANCEL** pad is pressed.

Setting Clock Controlled Oven Cooking Beeps

1. Press **COOK TIME** and **CLOCK** pads at the same time and hold for three seconds.
 - A single beep will sound.
 - Display will show current option.
2. Press the ▲ or ▼ pad to select the option number you wish. The current time of day will reappear in the display after four seconds.

Controls at a Glance (continued)

Cancel Clock Display Option

If you prefer that the time of day not be displayed:

To set: Press **CLOCK** and **CANCEL** pads at the same time and hold for three seconds.

When clock display is not shown, press **CLOCK** pad to briefly recall the time of day, if desired.

To restore: Press the **CLOCK** and **CANCEL** pads at the same time and hold for three seconds. The time of day will reappear in the display.

Automatic Oven Turn Off Option

The oven will automatically turn off after 12 hours, if you accidentally leave it on. You can deactivate this feature, if desired.

To Eliminate 12 Hour Turn Off



1. Press the **CLOCK** pad and hold for three seconds.
2. Press and hold the **▲** or **▼** pad until 8:88 appears in the display. Current time of day will reappear in the display after four seconds.

To restore: Repeat steps 1 and 2. 12:00 will appear briefly in the display followed by the current time of day.

Control Lock-Out Option

The Control Lock-Out feature prevents the oven from being turned on.

To Set Control Lock-Out

1. Press and hold both **STOP TIME** and **CANCEL** pads for three seconds.  and 
2. "OFF" will appear in the display when this feature is activated. Only the clock and timer functions will operate when Control Lock-Out feature is activated.

Repeat step 1 to deactivate.

Oven Temperature Adjustment Option

You may adjust the oven temperature if you think the oven is not baking correctly. To decide how much to change the temperature, set the temperature 25 degrees higher or lower than your recipe recommends, then bake. The results of the "test" should give you an idea of how much to adjust the temperature.

To Adjust the Oven Temperature

1. Press the **BAKE** pad.
2. Enter 550° by pressing **▲** pad.
3. Press and hold the **BAKE** pad for three seconds until 00° appears in the display.
 - If the oven temperature was previously adjusted, the change will be displayed. For example, if the oven temperature was reduced by 15°, the display will show -15°.
4. Press and hold the **▲** or **▼** pad to change the temperature. Each time a pad is pressed, the temperature changes by 5°.
 - The oven temperature can be **increased or decreased** by 5° to 35°.
5. The time of day will automatically reappear in the display.

It is not necessary to readjust the oven temperature if there is a power failure or interruption. Broiling and cleaning temperatures cannot be adjusted.

Oven Light

Push the switch on the control panel to turn it on and off. On select models the oven light automatically comes on whenever the oven door is opened.





Surface Cooking

! Surface Cooking CAUTIONS:

Before Cooking

- Always place a pan on the surface unit before you turn it on. To prevent damage to range, never operate surface unit without a pan in place.
- Do not use the cooktop as a storage area for food or cookware.

During Cooking

- Be sure you know which knob controls which surface unit. Make sure you turned on the correct surface unit.
- Begin cooking on a higher heat setting then reduce to a lower setting to complete the operation. Never use a high heat setting for extended cooking.
- Never allow a pan to boil dry. This could damage the pan and the appliance.
- Never touch cooktop until it has cooled. Expect some parts of the cooktop, especially around the surface units, to become warm or hot during cooking. Use potholders to protect hands.

After Cooking

- Be sure surface element and surface indicator light are off after cooking.
- Clean up messy spills as soon as possible.

Other Tips

- To eliminate the hazard of reaching over hot surface elements do not install cabinet storage directly above a unit.

If storage is provided, limit it to items that are infrequently used and can be safely stored in an area subjected to heat.

Temperatures may be unsafe for items such as volatile liquids, cleaners or aerosol sprays.

- Aerosol-type spray cans are **EXPLOSIVE** or highly flammable when exposed to heat. Avoid their use or storage near an appliance.
- Do not leave any items, especially plastic items, on the cooktop. The hot air from the vent may ignite flammable items, melt or soften plastics, or increase pressure in closed containers causing them to burst.
- Do not allow aluminum foil, meat probes or any other metal object, other than a pan on a surface element, to contact heating elements.

Surface Controls

Use to turn on the surface elements. An infinite choice of heat settings is available from **LOW** to **HIGH**. The knobs can be set on or between any of the numbered settings.

Setting the Controls

1. Place pan on surface element.
2. Push in and turn the knob in either direction to the desired heat setting.
 - The backguard is marked to identify which element the knob controls. For example,  indicates right front element.

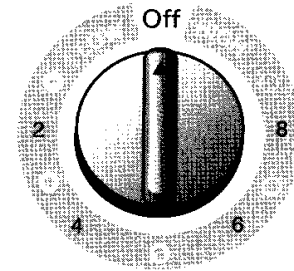

Suggested Heat Settings

The size and type of cookware will affect the heat setting. For information on cookware and other factors affecting heat settings, refer to “**Cooking Made Simple**” booklet.

Setting	Uses
HIGH	Use to bring liquid to a boil, blanch, or reach pressure in a pressure cooker. Always reduce setting to a lower heat when liquids begin to boil or foods begin to cook.
8 Med. Hi	Use to brown meat, heat oil for deep fat frying, saute or fry. Maintain fast boil for large amounts of liquids.
4-6 Med.	Use to maintain moderate to slow boil for large amounts of liquids and for most frying operations.
2 Med. Lo	Use to continue cooking covered foods and to maintain pressure in most pressure cookers and stew or steam operations.
LOW	Use to keep foods warm and melt chocolate and butter.

Surface Cooking (continued)

Surface Indicator Lights

There is an indicator light under each pair of control knobs. When one or both of the surface control knobs is turned on, the light will turn on. The light will turn off when the surface element(s) is turned off.

Hot Surface Lights

(glass-ceramic cooking surface models only)

Each element has a HOT SURFACE indicator light. A light will be illuminated when the matching surface element is hot. It will remain on, even after the control is turned off, until the area has cooled. They are located at the front center of the cooktop.

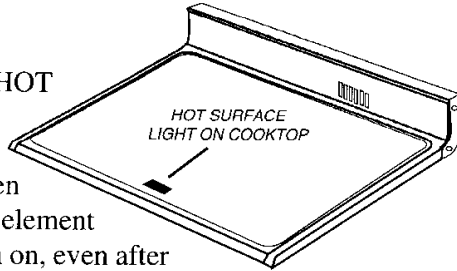

Coil Element Surface (select models)

Lift-up Porcelain Cooktop

To prevent the cooktop from discoloring or staining:

- Clean cooktop after each use.
- Wipe acid or sugar spills as soon as the cooktop has cooled as these spills may discolor or etch the porcelain.

Your range features an upswept porcelain cooktop that can be lifted up for convenient access to the area under the cooktop.

To lift cooktop: When cool, grasp the front edge of the cooktop. Gently lift up until the two support rods at the front of the cooktop snap into place.

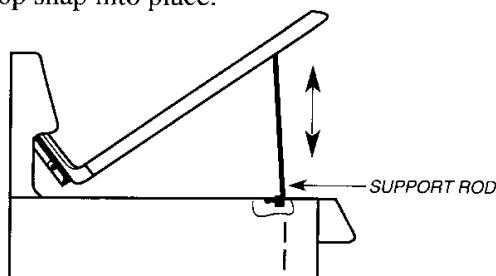

To lower cooktop: Hold the front edge of the cooktop and carefully push back on each support rod to release. Then gently lower the top into place. The support rods will slide into the range frame.

Coil Elements

- When an element is turned on, it will cycle on and off to maintain the heat setting.
- Coil elements are self-cleaning.
- Do not immerse in water.

To remove: When cool, raise element. Carefully pull out and away from receptacle.

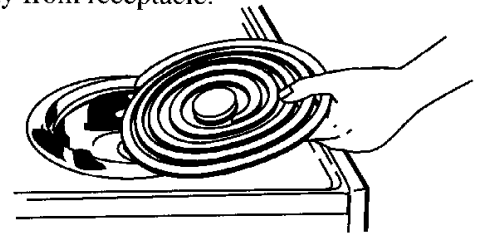

To replace: Insert terminals on the element into receptacle. Guide the element into place. Gently press down on the outer edge of the element until it sits level on the drip bowl.



Drip Bowls

The drip bowls, located under each surface element, are designed to catch boilovers and must always be used. Absence of these bowls during cooking may damage wiring or other parts underneath the cooktop.

To prevent the risk of electric shock or fire, never line drip bowls with aluminum foil.

Drip bowls will discolor or craze over time, if overheated. This discoloration or crazing is permanent. However, it will not affect cooking performance.

To protect drip bowl finish:

- Avoid using high heat settings for long periods of time.
- Do not use oversized cookware. Pans should not extend more than 1-2 inches beyond the element.
- When home canning, use the Canning Element (Model CE1). Contact your Maytag dealer for details.
- Clean frequently. (See cleaning section, page 17.)

Glass–Ceramic Surface (select models)



CAUTION: Do not use the cooktop if the glass is cracked or broken, or if metal melts on to it. Call an authorized servicer. Do not attempt to repair it yourself.

- On Canadian models, the right front element may not operate during a self-clean cycle. This is normal.
- Cooktop may emit a light smoke and odor the first few times the cooktop is used. This is normal.
- When a control is turned on, a red glow from the element can be seen through the glass–ceramic surface. The element will cycle on and off to maintain the preset heat setting.
- Glass–ceramic cooktops retain heat for a period of time after the unit is turned off. When the HOT SURFACE light turns off (see page 9), the surface will be cool enough to touch.

Cooking Areas

The cooking areas on your range are identified by permanent patterns on the glass–ceramic surface. For most efficient cooking, fit the pan size to the element size.

Pans should not extend more than 1/2 to 1-inch beyond the cooking area. (For more information on cookware, refer to “Cooking Made Simple” booklet.)

Tips to Protect the Surface

- Before first use, clean the cooktop as directed in the cleaning chart on page 18.
- Do not use glass pans. They may scratch the surface.
- Do not allow plastic, aluminum foil, sugar or foods with high sugar content to melt onto the hot cooktop. If these accidentally melt onto the cooktop, clean immediately. (See cleaning chart, page 18.)
- Never use cooktop as a work surface or cutting board.
- Never cook food directly on the surface.
- Never let a pan boil dry as this will permanently damage the surface and pan.
- Never use foil-type disposable containers or place a trivet or wok ring between the surface and pan. These items can mark or etch the top.
- Do not slide aluminum pans across a hot surface. The pans may leave marks which need to be removed promptly. (See cleaning chart, page 18.)
- Make sure the surface and the pan bottom are clean before turning on to prevent scratches.

Oven Light

⚠ CAUTIONS:

- Disconnect power to range before replacing light bulb.
- Use a dry potholder to prevent possible harm to hands when replacing bulb.
- Be sure bulb is cool before touching bulb.
- Do not touch hot bulb with a damp cloth as this may cause the bulb to break.

To replace oven light bulb:

1. When oven is cool, hold bulb cover in place, then slide wire retainer off cover. **NOTE:** Bulb cover will fall if not held in place while removing wire retainer.
2. Remove bulb cover and light bulb.
3. Replace with a 40 watt appliance bulb.
4. Replace bulb cover and secure with wire retainer.
5. Reconnect power to range. Reset clock.

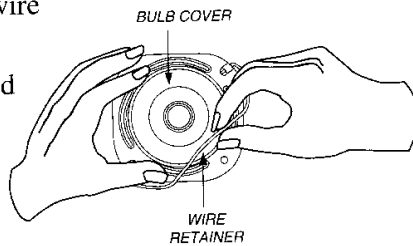

Storage Drawer

⚠ CAUTION:

- Do not store plastic, paper products, food or flammable materials in this drawer. The drawer may become too warm for these items when the oven is in use.

The storage drawer can be removed to allow you to clean under the range.

To remove:

1. Empty drawer and pull out to the first stop position.
2. Lift up the front of the drawer.
3. Pull out to the second stop position.
4. Grasp sides and lift drawer up and out.

To replace:

1. Fit the ends of the drawer glides into the rails in the range.
2. Lift up front of drawer and gently push in to the first stop position.
3. Lift drawer up again and push until drawer is closed.

Leveling Legs

⚠ CAUTION:

- Be sure the anti-tip bracket secures one of the rear leveling legs to the floor to prevent the range from accidentally tipping.

The range should be leveled when installed. If the range is not level, turn the plastic leveling legs, located at each corner of the range, until range is level.

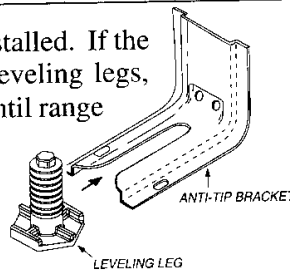

Oven Vent

When the oven is in use, the area near the vent may feel warm or hot to the touch. Never block the vent opening.

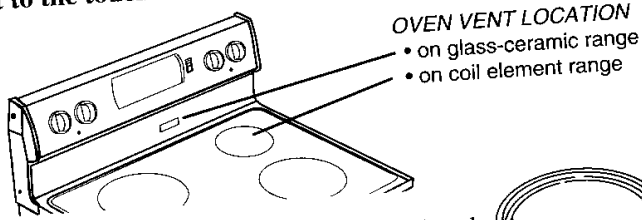

- On a coil element surface, be sure the drip bowl in the vent location has a hole in the center. Do not cover the drip bowl with aluminum foil.

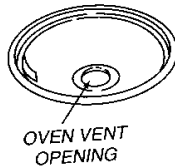

Oven Racks

CAUTION: Do not attempt to change the rack position when the oven is hot.

Your oven has two racks. They are designed with a lock-stop edge.

To remove: Pull rack straight out until it stops at the lock-stop position; lift up on the front of the rack and pull out.

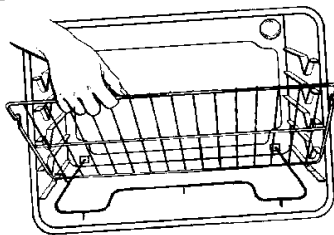

To replace: Place rack on the rack support in the oven; tilt the front end up slightly; slide rack back until it clears the lock-stop position; lower front and slide back into the oven.

Do not cover an entire rack with aluminum foil or place foil on the oven bottom. Baking results will be affected and damage may occur to the oven bottom.

Rack Positions

RACK 5 (highest position):
Used for toasting bread or broiling thin non-fatty foods.

RACK 4:
Used for most broiling.

RACK 3:
Used for most baked goods on a cookie sheet or jelly roll pan, layer cakes, fruit pies, or frozen convenience foods.

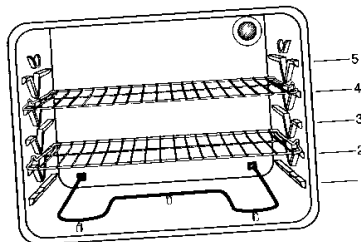

RACK 2:

Used for roasting small cuts of meat, casseroles, baking loaves of bread, bundt cakes or custard pies.

RACK 1:

Used for roasting large cuts of meat and poultry, frozen pies, dessert souffles or angel food cake.

Multiple Rack Cooking:

Two rack: Use rack positions 2 and 4, or 1 and 4.

Half Rack (select models)

To install in oven:

1. Always install half rack when oven is cool.
2. To install, grasp top center of the half rack. Align the side arm support between the top fourth and fifth oven rack guides. Insert the two tabs on the back frame of the half rack into the slots on the upper left rear of the oven wall.
3. Push firmly on the top surface of the half rack until the tabs slide into the slots and the half rack side arm support rests on the fourth oven rack guide.
4. Check for proper installation by placing your hand on the top surface of the half rack and pressing down firmly.

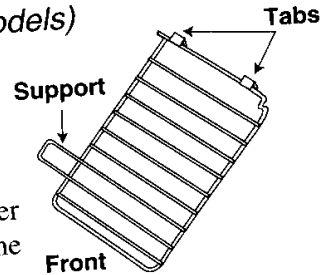

To remove from the oven:

When the oven is cool, grasp the top center of the half rack and pull upward until the back tabs on the rack slide out of the oven back slots.

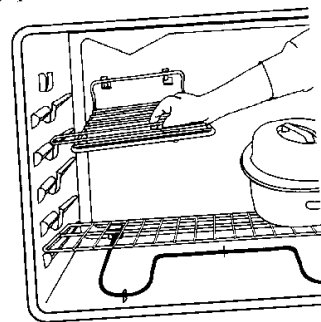

Notes:

- Do not use cookware that extends beyond edge of rack.
- For best results, allow two inches between the pan placed on the rack and the oven side wall.
- When opening the oven door, allow steam and hot air to escape before reaching into the oven to remove food.
- Use caution when removing items from the half rack to avoid burns.
- Carefully remove items from the lower rack to avoid disturbing the half rack.
- "HALFRACK" Accessory Kit is available from your dealer when not included with range.

Oven Operation (continued)

Broiling

• For best results, use a pan designed for broiling.

• For additional broiling tips, refer to the “Cooking Made Simple” booklet.

Setting the Controls for Broiling

1. Press the **BROIL** pad.

- BROIL indicator on the **BROIL** pad will light.
- 000 will light in the display.
- The OVEN ON indicator will light. There will be an eight second delay before the oven turns on.

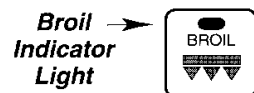

- OVEN ON
- PREHEAT
- LOCK

2. Press the ▲ pad to select **HI** (high) broil or the ▼ pad to set **LO** (low) broil.

- Select HI broil for normal broiling.
- Select LO broil for low temperature broiling of longer cooking foods such as poultry.

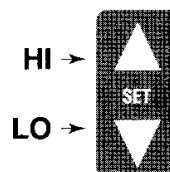

3. For optimum browning, preheat broil element for three to four minutes before adding food.

Expect broil times to increase and browning to be slightly lighter if appliance is installed on a 208 volt circuit.

4. Place food in the oven.

5. Turn meat once about half way through cooking.

6. Press **CANCEL** pad. Remove food and broiler pan from the oven.

- The OVEN ON indicator will turn off.
- The BROIL indicator on the **BROIL** pad will turn off.
- Time of day will reappear in display.



Broiling Chart

Type of Meat	Rack Position*	Doneness	Total Cook Time (Minutes)**
Bacon	4	Well Done	6-10 min.
Beef Steaks -- 1" thick	4	Medium	15-18 min.
	4	Well	19-23 min.
Chicken -- Pieces	3 or 4	Well Done	(LO Broil) 30-45 min.
Fish -- Fillets Steaks, 1" thick	4	Flaky	8-12 min.
	4	Flaky	10-15 min.
Ground Beef -- Patties, 3/4" thick	4	Well Done	15-18 min.
Ham -- Precooked Slice, 1/2" thick	4	Warm	8-12 min.
Pork Chops -- 1" thick	4	Well Done	22-26 min.

* The top rack position is #5.

** Broiling times are approximate and may vary depending on the meat.

Clock Controlled Oven Cooking

CAUTION

- Highly perishable foods such as dairy products, pork, poultry or seafood are not recommended for delayed cook operations.
- Baking is not recommended because preheating is required.

The clock must be functioning and set at the correct time of day for this feature to operate correctly.

Clock Controlled Oven Cooking is used to turn the oven on and off at a preset time of day. This feature can be used with either oven cooking or self-cleaning.

- **Immediate Start:** Oven turns on immediately and automatically turns off at a preset time.
- **Delayed Start:** Delays the start of cooking or cleaning and automatically turns off at a preset time.

Cook time can only be set for up to 11 hours and 59 minutes (11:59).

Setting the Controls for Clock Controlled Oven Cooking

1. Press the **COOK TIME** pad.
 - COOK TIME indicator on the **COOK TIME** pad will flash.
 - 0:00 will light in display.
2. Press or press and hold ▲ or ▼ pad to enter cooking time.

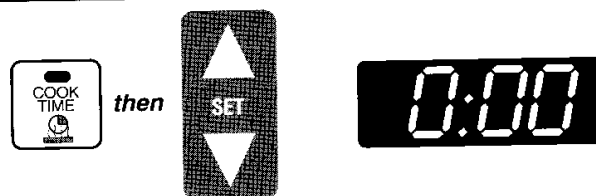

3. Press **BAKE** pad.
 - BAKE indicator on **BAKE** pad will light.
 - 000 will light in display.
4. Press or press and hold ▲ or ▼ pad to enter oven temperature.

NOTE: Beeps will sound and 000 will flash in display if the BAKE pad is not pressed within four seconds.

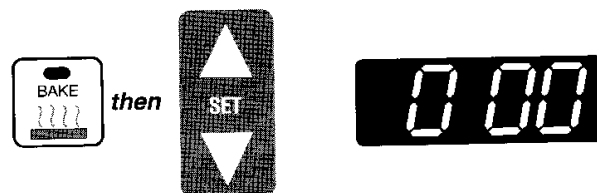

5. If You Wish to Delay the Start of Cooking:

(if not, skip to #6)

- a. Press **STOP TIME** pad.
 - STOP TIME indicator on **STOP TIME** pad will flash.
- b. Press or press and hold ▲ or ▼ pad to enter time of day you wish the oven to turn off.
- c. Press **CLOCK** pad.
 - Time of day will reappear in the display.

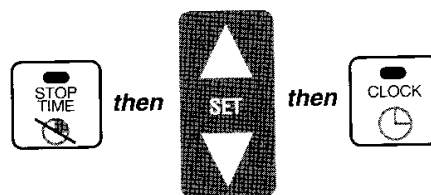

6. When the oven turns on, the **OVEN ON** indicator will light. The oven temperature will appear in the display. Press the **COOK TIME** pad to recall the remaining cook time.



NOTE: It is not necessary to set a start time. Control will determine when to turn the oven on based on the cook time you set.

7. Oven will automatically turn off. Four beeps will sound and "END" will light in the display. A beep will sound every 30 seconds for the next 5 minutes.

NOTE: See page 6 if you wish to change the end of cooking reminder beeps.

8. Press **CANCEL** pad and beeps will stop. Remove food from oven.





Care and Cleaning

Self-Clean Oven



Self-Clean CAUTIONS:

- It is normal for parts of the range to become hot during a clean cycle.
- Avoid touching cooktop, door, window, or oven vent area during a clean cycle.
- To prevent damage to oven door, do not attempt to open the door when the LOCK indicator word is displayed.
- **Do not use commercial oven cleaners** on the self-clean oven finish or around any part of the oven as they will damage the finish or parts.

The self-clean cycle uses above normal cooking temperatures to automatically clean the entire oven interior.

It is normal for excessive flare-ups, smoking and flaming to occur during cleaning if the oven is heavily soiled. It is better to clean the oven regularly rather than to wait until there is a heavy build-up of soil in the oven.

During the cleaning process, the kitchen should be well ventilated to help eliminate normal odors associated with cleaning.

Before Self-Cleaning

Turn off the oven light before cleaning as the light may burn out during the clean cycle.

Remove broiler pan, all pans and the oven racks from the oven. **The oven racks will discolor and may not slide easily after a self-clean cycle.**

Clean oven frame, door frame (area outside the door gasket) and around the opening in the door gasket with a nonabrasive cleaning agent such as Bon Ami or detergent and water. These areas are not exposed to cleaning temperatures and should be cleaned to prevent soil from baking on during the clean cycle.

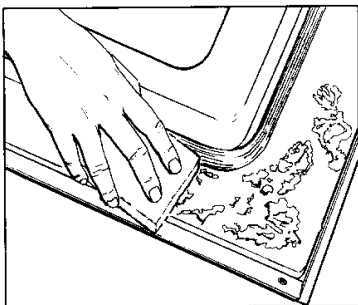

To prevent damage, do not clean or rub the gasket around the oven door. The gasket is designed to seal in heat during the clean cycle.

Wipe up excess grease or spillovers from the oven bottom to prevent excessive smoking, flare-ups or flaming during the clean cycle. For ease of cleaning, the heating element can be lifted slightly (1 to 1 1/2 inches).

Wipe up sugary and acid spillovers such as sweet potatoes, tomato or milk-based sauces. Porcelain enamel is acid resistant, not acid proof. **The porcelain finish may discolor if acid spills are not wiped up prior to a self-clean cycle.**

During Clean Cycle

When the LOCK indicator word lights in the display, the door cannot be opened. To prevent damage to door, do not force door open when the LOCK indicator word is displayed.

Some smoke and odor may be detected the first few times the oven is cleaned. This is normal and will lessen in time. Smoking may also occur if oven is heavily soiled or if broiler pan was left in oven.

As oven heats, you may hear sounds of metal parts expanding and contracting. This is normal and will not damage oven.

After Self-Cleaning

About one hour after the end of the clean cycle, the LOCK indicator word will turn off. At this point, the door can be opened.

Some soil may leave a light gray, powdery ash which can be removed with a damp cloth. If soil remains, it indicates that the clean cycle was not long enough. The soil will be removed during the next clean cycle.

If the oven racks were left in the oven and do not slide smoothly after a clean cycle, wipe racks and embossed rack supports with a small amount of vegetable oil to restore ease of movement.

A white discoloration may appear after cleaning if acid or sugary foods were not wiped up before the clean cycle. This discoloration is normal and will NOT affect performance.

Setting the Controls for Self Clean

NOTE: These instructions cover automatic lock and manual lock models.

1. Close oven door.



2. Move door lock lever right to the locked position (select models).

3. Press **CLEAN** pad.

- **CLEAN** indicator on the **CLEAN** pad will flash.
- **LOCK** indicator will light on models with automatic lock feature.
- “- : - -” or 3:00 will light in display depending on your model.
- If door is not closed or locked, “dr” will appear in display.



4. Press ▲ or ▼ pad to select clean time or change clean time.

- Oven will automatically clean for 3 hours. Or,
- Select 2 hours for light soil up to 4 hours for heavy soil.

5. **IF YOU WISH TO DELAY THE START OF CLEANING** (if not, skip to #6):

- Press **STOP TIME** pad.
- Press ▲ pad to select the time of day you wish the oven to turn off.
- Press **CLOCK** pad and time of day will reappear in display.
- Press **STOP TIME** pad to recall the time you set.

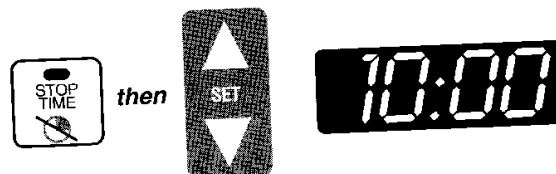

6. When the oven turns on:

- The **OVEN ON** indicator will light.
- **LOCK** indicator will light when oven heats to 400°F on models with a manual door lock.
- Door cannot be opened when **LOCK** indicator is lit.

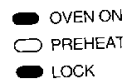

7. About one hour after the clean cycle ends, the **LOCK** indicator will turn off. The oven door can be opened. (Select models - move door lock lever to the left to unlock.)

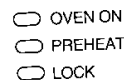

TO CANCEL CLEAN CYCLE:

1. Press **CANCEL** pad.

2. If **LOCK** indicator is NOT lit, unlock (select models) and open oven door. If **LOCK** indicator is lit, allow oven to cool about one hour then unlock (select models) and open oven door.

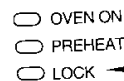

← **WHEN LIGHT TURNS OFF, OPEN DOOR.**

Care & Cleaning (continued)

▲ Cleaning CAUTIONS:

- Be sure appliance is off and all parts are cool before handling or cleaning. This is to avoid damage and possible burns.
- To prevent staining or discoloration, clean appliance after each use.
- If a part is removed, be sure it is correctly replaced.

Cleaning Chart

Parts	Cleaning Procedure
Backguard & Cooktop, porcelain enamel Cooktop on coil elements Trim on glass-ceramic surfaces	Porcelain enamel is glass fused on metal and may crack or chip with misuse. It is acid resistant, not acid proof. All spillovers, especially acid or sugar spillovers, should be wiped up immediately with a dry cloth. <ul style="list-style-type: none"> • When cool, wash with soapy water, rinse and dry. • Never wipe off a warm or hot surface with a damp cloth. This may cause cracking or chipping. • Never use oven cleaners, abrasive or caustic cleaning agents on exterior finish of range.
Broiler Pan and Insert	<i>Never cover insert with aluminum foil as this prevents the fat from draining to the pan below.</i> <ul style="list-style-type: none"> • Place soapy cloth over insert and pan; let soak to loosen soil. • Wash in warm soapy water. Use soap filled scouring pad to remove stubborn soil. • Broiler pan and insert can be cleaned in dishwasher.
Clock & Control Pad Area	<ul style="list-style-type: none"> • To activate "Control Lock" for cleaning, see page 5. • Wipe with a damp cloth and dry. • Glass cleaners may be used if sprayed on a cloth first. DO NOT spray directly on control pad and display area.
Control Knobs	<ul style="list-style-type: none"> • Remove knobs in the OFF position by pulling forward. • Wash, rinse and dry. Do not use abrasive cleaning agents as they may scratch the finish. • Turn on each element to be sure the knobs have been correctly replaced.
Drip Bowls, porcelain (select models)	Porcelain may craze if overheated. This is normal and will not affect cooking performance. <ul style="list-style-type: none"> • When cool, wash after each use, rinse and dry to prevent staining or discoloration. May be washed in the dishwasher. • To clean heavy soil, soak in hot sudsy water, then use mild abrasive cleaner such as Soft Scrub and a plastic scouring pad. • For burned on soil, remove from range, place on newspapers and carefully spray with commercial oven cleaner. (<i>Do not spray surrounding surfaces.</i>) Place in plastic bag and allow to soak several hours. Wearing rubber gloves, remove from bag, wash, rinse and dry.
Enamel, painted Side panels Storage drawer	<ul style="list-style-type: none"> • When cool, wash with warm soapy water, rinse and dry. Never wipe a warm or hot surface with a damp cloth as this may damage the surface and may cause a steam burn. • For stubborn soil, use mildly abrasive cleaning agents such as baking soda paste or Bon Ami. Do not use abrasive, caustic or harsh cleaning agents such as steel wool pads or oven cleaners. These products will scratch or permanently damage the surface. <p>NOTE: Use dry towel or cloth to wipe up spills, especially acid or sugary spills. Surface may discolor or dull if soil is not immediately removed. This is especially important for white surfaces.</p>

Cleaning Chart -- continued

Parts	Cleaning Procedure
<p>Glass Oven window Oven door</p>	<ul style="list-style-type: none"> • Avoid using excessive amounts of water which may seep under or behind glass. • Wash with soap and water or glass cleaner. Remove stubborn soil with a nonabrasive cleaner such as Bon Ami and water. Rinse with clear water and dry. • Do not use abrasive materials such as scouring pads, steel wool or powdered cleaning agents. They will damage glass.
<p>Glass-Ceramic Cooktop (select models)</p>	<p><i>Never use oven cleaners, chlorine bleach, ammonia or glass cleaners with ammonia.</i></p> <p>NOTE: Call an authorized servicer if the glass-ceramic surface should crack, break or if metal or aluminum foil should melt on the cooktop.</p> <ul style="list-style-type: none"> • General Cleaning and Light Soil – Use soap and water and a clean cloth or paper towel, or nonabrasive cleaner such as Bon Ami. Rinse and dry. Commercial cooktop cleaners may also be used such as Cooktop Cleaning Creme (Part No. 20000001). Follow package directions. • Heavy Soils or Metal Marks – Gently scrub with Cooktop Cleaning Creme and a plastic scrubber. Reapply cleaner. Cover with damp paper towels to keep cleaner moist. Let stand for 30 to 45 minutes. Scrub again to remove remaining stain. Rinse and dry. • Burned-on or Crusty Soils – Hold razor blade scraper at 30° angle and very carefully scrape off soil. Clean remaining soil with method described above. • Melted Sugar or Plastic – Immediately turn element to LOW and scrape from hot surface to a cool area. Then turn element OFF and cool. Clean residue with razor blade scraper and Cooktop Cleaning Creme as described above.
<p>Metal Finishes Trim parts</p>	<ul style="list-style-type: none"> • Wash with soap and water, a glass cleaner, or mild liquid sprays. • To prevent scratching or dulling of the finish, do not use mildly abrasive, abrasive, harsh or caustic cleaners such as oven cleaners.
<p>Oven Interior</p>	<ul style="list-style-type: none"> • Follow instructions on pages 15-16 for Self-Cleaning Oven.
<p>Oven Racks</p>	<ul style="list-style-type: none"> • Clean with soapy water. • Remove stubborn soil with cleansing powder or soap-filled scouring pad. Rinse and dry. <p>Racks will permanently discolor and may not slide smoothly if left in the oven during a self-clean operation. If this occurs, wipe the rack and embossed rack supports with a small amount of vegetable oil to restore ease of movement, then wipe off excess oil.</p>
<p>Plastic Finishes Door handles Backguard trim End caps</p>	<ul style="list-style-type: none"> • When cool, clean with soap and water, rinse and dry. • Use a glass cleaner and a soft cloth. <p>NOTE: Never use oven cleaners, abrasive or caustic liquid or powdered cleansers on plastic finishes. These cleaning agents will scratch or mar finish.</p> <p>NOTE: To prevent staining or discoloration, wipe up fat, grease or acid (tomato, lemon, vinegar, milk, fruit juice, marinade) immediately with a dry paper towel or cloth.</p>

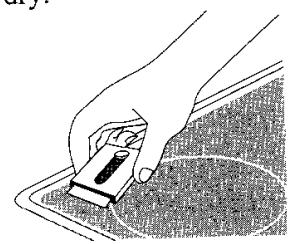



Maintenance.....

Cleaning Products

Because of the many new cleaning products introduced in the marketplace each year, it is not possible to list all products that can be safely used to clean this appliance. Listed below are just a few examples of recommended products.

READ THE MANUFACTURER'S INSTRUCTIONS to be sure the cleaner can be safely used on this appliance.

To determine if a cleaning product is safe, test a small inconspicuous area using a very light pressure to see if the surface may scratch or discolor. This is particularly important for porcelain enamel, highly polished, shiny, painted, or plastic surfaces.

The following brands may help you to make an appropriate selection:

- **Glass Cleaners** - Cinch, Glass Plus, Windex. (Avoid glass cleaners with ammonia on glass-ceramic cooking surfaces.)
- **Dishwashing Liquid Detergents** - Dawn, Ivory, Joy.
- **Mild Liquid Spray Cleaners** - Fantastik, Formula 409.
- **Multi-Surface Cleaners** - Formula 409 Glass & Surface, Windex Glass & Surface.
- **Nonabrasive Cleaners** - Bon Ami, paste of baking soda and water.
- **Mildly Abrasive Powder or Liquid Cleaners** - Ajax, Barkeepers Friend, Cameo, Soft Scrub, Smart Cleanser. (Note: If the cleaner is recommended for use on plastic, glass, or porcelain finishes, it can be used on the same type of appliance finish.)
- **Nonabrasive or Scratchless Plastic or Nylon Scouring Pads or Sponges** - Chore Boy Plastic Cleaning Puff, Scrunge Scrub Sponges, Scotch-Brite No Scratch Pads.
- **Abrasive Scouring Pads** - S.O.S., Brillo Steel Wool Soap, Scotch-Brite Wool Soap Pads.

(Brand names for the above cleaning products are registered trademarks of the respective manufacturers.)

Oven Door

! CAUTIONS:

- Do not place excessive weight on or stand on an open oven door. This could cause the range to tip over, break the door, or injure the user.
- Do not attempt to open or close door or operate oven until door is properly replaced.
- Never place fingers between hinge and front oven frame. Hinge arms are spring mounted. If accidentally hit, the hinge will slam shut against oven frame and could injure your fingers.

To remove:

1. When cool, open the oven door to the broil stop position (opened about four inches).
2. Grasp door at each side. Do not use the door handle to lift door.
3. Lift up evenly until door clears hinge arms.

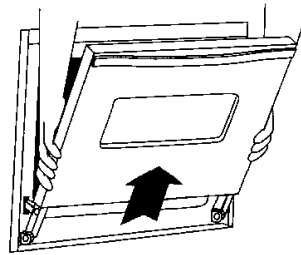

To replace:

1. Grasp door at each side.
2. Align slots in the door with the hinge arms on the range.
3. Slide the door down onto the hinge arms until the door is completely seated on the hinges. Push down on the top corners of the door to completely seat door on hinges. Door should not appear crooked.

NOTE: The oven door on a new range may feel "spongy" when it is closed. This is normal and will decrease with use.

Oven Window

To protect the oven door window:

1. Do not use abrasive cleaning agents such as steel wool scouring pads or powdered cleansers as they may scratch the glass.
2. Do not hit the glass with pots, pans, furniture, toys, or other objects.
3. Do not close the oven door until the oven racks are in place.

Scratching, hitting, jarring or stressing the glass may weaken its structure causing an increased risk of breakage at a later date.

Oven Light

⚠ CAUTIONS:

- Disconnect power to range before replacing light bulb.
- Use a dry potholder to prevent possible harm to hands when replacing bulb.
- Be sure bulb is cool before touching bulb.
- Do not touch hot bulb with a damp cloth as this may cause the bulb to break.

To replace oven light bulb:

1. When oven is cool, hold bulb cover in place, then slide wire retainer off cover. **NOTE:** Bulb cover will fall if not held in place while removing wire retainer.
2. Remove bulb cover and light bulb.
3. Replace with a 40 watt appliance bulb.
4. Replace bulb cover and secure with wire retainer.
5. Reconnect power to range. Reset clock.

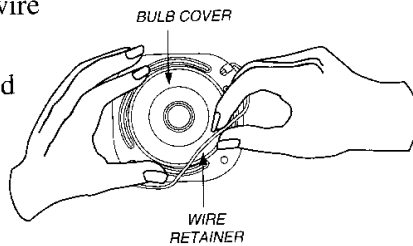

Storage Drawer

⚠ CAUTION:

- Do not store plastic, paper products, food or flammable materials in this drawer. The drawer may become too warm for these items when the oven is in use.

The storage drawer can be removed to allow you to clean under the range.

To remove:

1. Empty drawer and pull out to the first stop position.
2. Lift up the front of the drawer.
3. Pull out to the second stop position.
4. Grasp sides and lift drawer up and out.

To replace:

1. Fit the ends of the drawer glides into the rails in the range.
2. Lift up front of drawer and gently push in to the first stop position.
3. Lift drawer up again and push until drawer is closed.

Leveling Legs

⚠ CAUTION:

- Be sure the anti-tip bracket secures one of the rear leveling legs to the floor to prevent the range from accidentally tipping.

The range should be leveled when installed. If the range is not level, turn the plastic leveling legs, located at each corner of the range, until range is level.

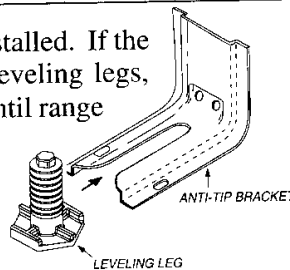



Before You Call for Service

Check these points if ...

Part or all of the appliance does not work.

- Check to be sure plug is securely inserted into receptacle.
- Check or re-set circuit breaker. Check or replace fuse.
- Check power supply.
- Check if surface and/or oven controls have been properly set. See pages 8 and 11.
- Check if oven door is unlocked after a self-clean cycle. See pages 15-16.
- Check if oven is set for a delayed cook or clean program. See page 14.

Surface or oven elements fail to operate or heat food.

NOTE: On Canadian models, the right front element on glass-ceramic cooking surfaces may not operate during a self-clean cycle.

- Check to be sure plug is securely inserted into receptacle.
- Check or re-set circuit breaker. Check or replace fuse.
- Check power supply.
- Check if surface and/or oven controls have been properly set. See pages 8 and 11.
- Check if coil element is properly installed. See page 9.
- Check if oven is set in a delayed oven operation.
- Check to see if coil elements need to be replaced.

Glass-ceramic surface shows wear.

1. Tiny scratches or abrasions.
 - Check to make sure cooktop and pan bottom are clean. Do not slide glass or metal pans across top. Make sure pan bottom is not rough. Use the recommended cleaning agents. See page 18.
2. Metal marks.
 - Do not slide metal pans across top. If it happens, clean when cool with Cooktop Cleaning Creme. See page 18.
3. Brown streaks and specks.
 - Spills not removed promptly. Wiping with soiled cloth or sponge. Pan bottom not clean.
4. Areas with a metallic sheen.
 - Mineral deposits from water and food.
5. Pitting or flaking.
 - Sugary boilovers that were not removed promptly. See page 18.

Baking results are not what you expected.

- Check the oven temperature selected. Make sure oven is preheated when recipe or directions recommend preheat.
- Check rack positions. See page 12.
- Use correct pan. Dark pans produce dark browning. Shiny pans produce light browning. See "Cooking Made Simple" booklet for more information on bakeware.
- Check the use of foil in the oven. Never use foil to cover an entire oven rack. Place a small piece of foil on the rack below the pan to catch spillovers.
- Check pan placement. Stagger pans when using two racks. Allow 1-2 inches between pans and oven walls.
- Make sure the oven vent has not been blocked. See page 12 for location.
- Check to make sure range is level.

Baking results differ from previous oven.

- Temperatures often vary between a new oven and an old one. As ovens age, the oven temperature often "drifts" and may become hotter or cooler. See page 7 for instructions on adjusting the oven temperature.
- NOTE:** It is not recommended to adjust the temperature if only one or two recipes are in question.

Food is not broiling properly.

- Check oven setting. See page 13.
- Check oven rack positions. See page 13.
- Broil element was not preheated.
- Aluminum foil was incorrectly used. Never line the broiler insert with foil.
- Oven door was closed during broiling. Leave the door open to the first stop position (about 4-inches).

Oven smokes excessively during broiling.

- Food too close to element. See page 13 for more information.
- Broiler insert covered with aluminum foil.
- Trim excess fat from meat prior to broiling.
- A soiled broiler pan was used.

Oven will not self-clean.

- Check to make sure controls are set properly. See page 16.
- Check to make sure the cycle is not set for a delayed start.
- Check if door is closed.

Oven did not clean properly.

- Longer cleaning time may be needed.
- Excessive spillovers, especially sugary and/or acid foods, were not removed prior to the self-clean cycle.

Oven door will not unlock after self-clean cycle.

- Oven interior is still hot. Allow about one hour for the oven to cool after the completion of a self-clean cycle. The door can be opened when the LOCK indicator word is not displayed.

Moisture condensation collects on oven window.

- This is normal when cooking food high in moisture.
- Excessive moisture was used when cleaning the window.

There is a strong odor or light smoke when oven is turned on.

- This is normal for a new range and will disappear after a few uses. Initiating a clean cycle will "burn off" the smells more quickly.
- Turning on a ventilation fan will help remove the smoke and/or odor.
- Excessive food soils on the oven bottom. Use a self-clean cycle.

"F" plus a number appears in display.

- This is called a fault code. If a fault code appears in the display and beeps sound, press the **CANCEL** pad. If the fault code and beeps continue, disconnect power to the appliance. Wait a few minutes, then reconnect power. If fault code and beeps still continue, disconnect power to the appliance and call an authorized servicer.
- If the oven is heavily soiled, excessive flare-ups may result in a fault code during a clean cycle. Press **CANCEL** pad and allow the oven to cool for one hour, then reset the clean cycle. If the fault code and beeps still continue, disconnect power to the appliance and call an authorized servicer.

If You Need Service

- Call the dealer from whom your appliance was purchased or call Maytag Appliances Sales Company, Maytag Customer Assistance at 1-800-688-9900, USA or 1-800-688-2002, CANADA to locate an authorized servicer.
- Be sure to retain proof of purchase to verify warranty status. Refer to **WARRANTY** (next page) for further information of owner's responsibilities for warranty service.
- If the dealer or service company cannot resolve the problem, write to Maytag Appliances Sales Company, Attn: CAIRSM Center, P.O. Box 2370, Cleveland, TN 37320-2370, or call **1-800-688-9900, USA or 1-800-688-2002, CANADA.**

U.S. customers using TTY for deaf, hearing impaired or speech impaired, call 1-800-688-2080.

NOTE: When writing or calling about a service problem, please include the following information:

- a. Your name, address and telephone number;
 - b. Model number and serial number;
 - c. Name and address of your dealer or servicer;
 - d. A clear description of the problem you are having;
 - e. Proof of purchase (sales receipt).
- User's guides, service manuals and parts catalogs are available from Maytag Appliances Sales Company, Maytag Customer Assistance.



Maytag Range Warranty

Full One Year Warranty - Parts and Labor

For **one (1) year** from the original retail purchase date, any part which fails in normal home use will be repaired or replaced free of charge.

Limited Warranties - Parts Only

Second Year - After the first year from the original purchase date, parts which fail in normal home use will be repaired or replaced free of charge for the part itself, with the owner paying all other costs, including labor, mileage and transportation.

Third Through Fifth Year - From the original purchase date, parts listed below which fail in normal home use will be repaired or replaced free of charge for the part itself, with the owner paying all other costs, including labor, mileage and transportation.

- **Electronic Controls**
- **Glass-ceramic Cooktop:** due to thermal breakage.
- **Electric Heating Elements:** surface, broil and bake elements on electric cooking appliances.

Third Through Tenth Year - From the original purchase date, parts listed below which fail in normal home use will be repaired or replaced free of charge for the part itself, with the owner paying all other costs, including labor, mileage and transportation.

- **Sealed Gas Burners**

Canadian Residents

The above warranties only cover an appliance installed in Canada that has been certified or listed by appropriate test agencies for compliance to a National Standard of Canada unless the appliance was brought into Canada due to transfer of residence from the United States to Canada.

Limited Warranty Outside the United States and Canada - Parts Only

For two (2) years from the date of original retail purchase, any part which fails in normal home use will be repaired or replaced free of charge for the part itself, with the owner paying all other costs, including labor, mileage and transportation.

*The specific warranties expressed above are the **ONLY** warranties provided by the manufacturer. These warranties give you specific legal rights, and you may also have other rights which vary from state to state.*

What is Not Covered By These Warranties:

1. Conditions and damages resulting from any of the following:
 - a. Improper installation, delivery, or maintenance.
 - b. Any repair, modification, alteration, or adjustment not authorized by the manufacturer or an authorized servicer.
 - c. Misuse, abuse, accidents, or unreasonable use.
 - d. Incorrect electric current, voltage, or supply.
 - e. Improper setting of any control.
2. Warranties are void if the original serial numbers have been removed, altered, or cannot be readily determined.
3. Light bulbs.
4. Products purchased for commercial or industrial use.
5. The cost of service or service call to:
 - a. Correct installation errors.
 - b. Instruct the user on the proper use of the product.
 - c. Transport the appliance to the servicer.
6. Consequential or incidental damages sustained by any person as a result of any breach of these warranties.

Some states do not allow the exclusion or limitation of consequential or incidental damages, so the above exclusion may not apply.

MAYTAG • 403 West Fourth Street North • P.O. Box 39 • Newton, Iowa 50208