



# USER'S GUIDE

Congratulations on your purchase of a Maytag Performa™ clothes washer! Your satisfaction is very important to us.

**Read this manual for best results.** It contains instructions to acquaint you with proper operating and maintenance procedures.

In addition you will find a *Laundering Tips* guide packed with your clothes washer. It contains information on recommended laundering procedures, stain removal and special laundering situations.

**Save time and money.** If something should go wrong, we suggest consulting the "Before You Call" section. It is designed to help you solve basic problems before consulting a servicer.

If you have questions, write us (include your model and serial numbers and your phone number) or call:

Maytag Appliances Sales Company  
 Attn: CAIR® Center  
 P.O. Box 2370  
 Cleveland, TN 37320-2370  
 1-800-688-9900 USA  
 1-800-688-2002 CANADA  
 1-800-688-2080 USA TTY (for deaf, hearing impaired, or speech impaired)  
 (Mon.–Fri., 8am–8pm Eastern Time)  
 Internet: <http://www.maytag.com>

## Table of Contents

Safety Instructions . . . . .	1
Operating Tips . . . . .	2
Controls at a Glance . . . . .	3-4
Special Features . . . . .	5-6
Care and Cleaning . . . . .	6
Before You Call . . . . .	7
Warranty . . . . .	8
Guide de L'Utilisateur . . . . .	10
Guía del Usuario . . . . .	20

# Important Safety Instructions



**WARNING:** To reduce the risk of fire, explosion, electric shock, or personal injury when using your washer, follow basic safety precautions, including the following:

1. Read all instructions carefully before using the washer. Retain all instructions for future reference.
2. Properly install and locate in accordance with the Installation Instructions.  
Must be properly grounded-See Installation Instructions.  
Should anyone get an electric shock from the washer, disconnect electrical power. Do not operate until it has been repaired by a qualified service technician.  
Install or store where it will not be exposed to temperatures below freezing or exposed to the weather.  
Connect to a properly rated, protected and sized power supply circuit. See Electrical Requirements.  
Connect to adequate plumbing and drain facilities.  
Have a qualified service technician install your washer.
3. To prevent injury to children:  
Do not allow children to play inside, on, or with the washer.  
Close supervision of children is necessary when using the washer.  
When children are mature enough, instruct them in the safe, correct use of the washer.  
Keep all laundry aids out of the reach of children, preferably in a locked cabinet. Use laundry aids only as directed by the manufacturer observing all warnings on container labels.  
Destroy the carton and plastic bags after unpacking the washer. Cartons covered with rugs, bedspreads, or plastic sheet can create a chamber with inadequate ventilation.  
Remove the door to the washing compartment before the washer is removed from service or discarded.
4. Do not reach into the washer if the tub or agitator is moving. The washer is equipped with a safety switch for your protection. If action does not stop when the washer lid is opened during the spin cycle, disconnect the electrical power to the washer. Do not operate the washer until it has been repaired by a qualified technician.
5. Do not tamper with the operating controls.
6. To prevent personal injury and damage to the washer, do not repair or replace any part of the washer or attempt any servicing. Servicing should be referred to a qualified service technician.
7. Do not wash fiberglass articles unless recommended by manufacturer.
8. Flame resistant finishes – improper laundering could remove them. Follow garment manufacturer's instructions carefully.
9. When moving, have the washer checked and properly installed by a qualified technician.
10. Inlet hoses are subject to damage and deterioration over time. Check the hoses periodically for bulges, kinks, wear or leaks and replace them every five years.

## WARNING! FIRE HAZARD

Do not add gasoline, dry-cleaning solvents, or other flammable or explosive substances to the wash water. These substances give off vapors that could ignite or explode.

Do not wash articles which have been previously cleaned with gasoline, dry-cleaning solvents, oil, waxes, chemical solvents, alcohol, turpentine, or other flammable or explosive materials. These substances will be retained in articles, and articles which still contain these flammable or explosive substances give off vapors that could ignite or explode.

Observe these precautions when using cleaning fluids, spot or stain removers, etc. These products should be labeled "nonflammable." Use according to manufacturer's directions in a well ventilated area or outdoors. Thoroughly rinse articles by hand before placing them in the washer. Some of these products – rust removers, for example – will damage components and the finish of the washer.

Keep area around and underneath washer free from accumulation of combustible materials, such as newspapers, paper, rags, gasoline, and all other flammable vapors and liquids.

**HYDROGEN GAS IS EXPLOSIVE!** Under certain conditions, hydrogen gas may be produced in a hot water system that has not been used for two weeks or more. If the hot water system has not been used for such a period before using the washer, turn on all the hot water faucets and let the water flow from each faucet for several minutes. This will release any accumulated hydrogen gas. As this gas is flammable, do not smoke or use an open flame during this procedure.

Recent studies have shown that if vegetable oil contaminated materials are incompletely washed, a carry-over and buildup of the oil may contribute to a chemical reaction (spontaneous combustion) that could cause a load to catch fire by itself. This would be more likely to happen if the load were left in the dryer after tumbling stopped or if items were folded and stacked while warm.

# Operating Tips

*For detailed information on sorting, pretreating stains, etc., see the enclosed Laundering Tips pamphlet.*

## Detergent

- Use either liquid or granular laundry detergent. For best results, be sure detergent is added to the washer **BEFORE** the load and be sure the wash water is above 65° F.
- Use the correct amount of detergent for the load size, soil level and water conditions. Use more detergent if you have hard water and very soiled loads.  
If you have soft water or a lightly soiled load, use less detergent. (See manufacturer's instructions.)
- Wipe up any detergent spills on the washer.

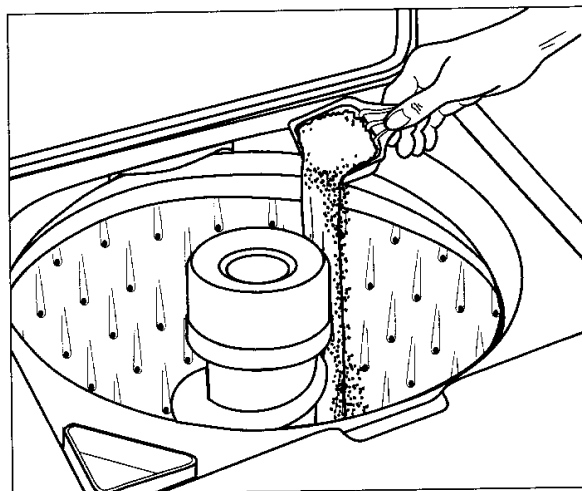

## Loading

- Put dry, unfolded clothes loosely in the tub, up to the top row of holes for a maximum load.
- Do not wrap large items like sheets around the agitator.
- Mix large and small items for best circulation. Wash bulky items like blankets separately.
- When laundering wrinkle free items or items of delicate construction, washable woolens or loosely knit items, never use less than the **MEDIUM** water level setting. This will minimize shrinkage, wrinkling and pulling of seams.

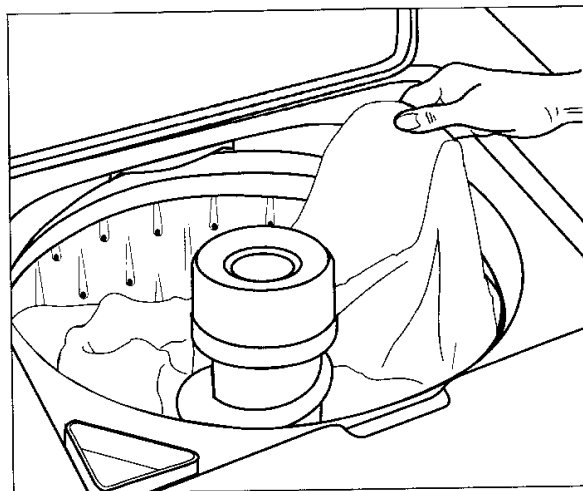

## Additional Tips

- The washer will pause briefly throughout each cycle. These pauses are normal.
- This washer is designed so that it will not spin when the lid is open. It will, however, fill and agitate with the lid open so water is available for pretreating stains or diluting fabric softener.
- If you open the lid during a spin cycle, the washer will stop. When the lid is closed and the control dial pulled out, the washer will continue the cycle at the point it was interrupted.

# Controls at a Glance

\* See Laundering Tips for proper washing procedure, stain removal, and special laundering situations.

## Step 1

### Select Water Level

Determine the selected setting based on clothes load size. This infinite control allows you to select a specific setting or anywhere in between.

It may become necessary, due to bulky fabrics, to adjust the water level after agitation begins. To adjust the water level, turn the control to **RESET** and then back to the desired setting.

WATER LEVEL SETTING	LOAD SIZE
Oversize	3/4 - Full
Large	1/2 - 3/4 Full
Medium	1/4 - 1/2 Full
Mini	1/4 Full

**REMEMBER:** Items must circulate freely for best results.

## Step 2

### Select Wash/Spin Speed

Your washer has selectable wash and spin speed combinations.

WASH/SPIN SPEEDS	LOAD TYPE
Regular/Fast	Sturdy fabrics needing maximum water extraction.
Delicate/Fast	Heavy loads of delicate fabrics needing a fast spin for better water extraction.
Delicate/Slow	Delicate fabrics needing slower spin speed because of clothing construction.

**REMEMBER:** In wash water temperatures below 65° F, detergents do not dissolve well or clean well. Care labels define cold water as up to 85° F.

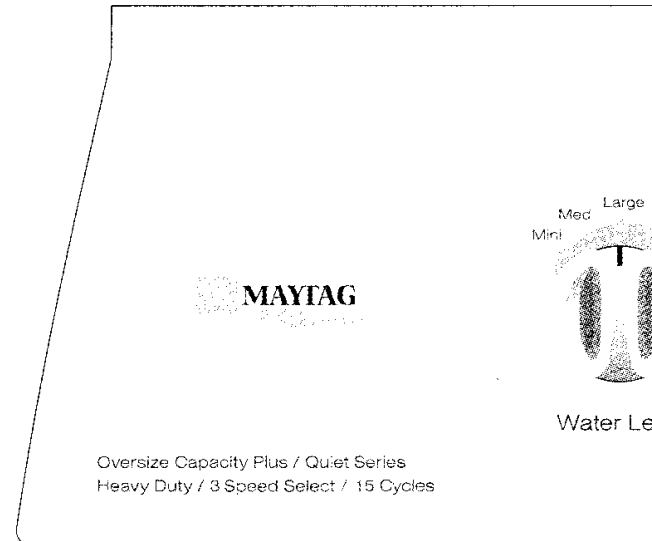

Control panel features vary by model.

## Step 3

### Select Wash/Rinse Temperature

Your washer provides you with a choice of hot, warm or cold water for washing and cold or warm water for rinsing. Use the chart below as a guide.

WASH/RINSE TEMPS	LOAD TYPE
Hot/Cold	White and heavily soiled, colorfast items
Warm/Warm	Delicate items
Warm/Cold	Moderately soiled, colorfast items; most wrinkle free items
Cold/Cold	Brightly colored, lightly soiled items; washable woolsens

See Laundering Tips for proper washing procedure, stain removal and special laundering situations.

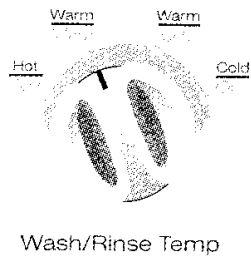
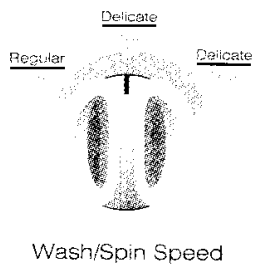

Wrinkle Free Fabrics

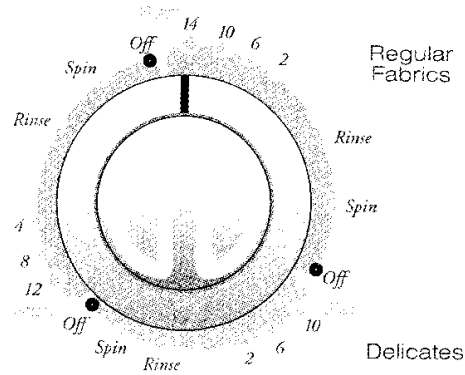

Pull to Start • Push to Stop

## Step 4 Select Cycle

To select a cycle, push the control dial IN (off position) and turn it to the right (clockwise) until the pointer is at the number of minutes desired for the wash load in the Regular, Wrinkle Free, or Delicate cycles.

### Regular Fabrics Cycle

For regular fabrics, select the cycle and turn the Wash/Spin Speed dial to Regular/Fast.

### Wrinkle Free Fabrics Cycle

This cycle provides up to 12 minutes of agitation. Select the Delicate/Fast Wash/Spin speed.

### Delicates Cycle

For delicate fabrics, select the cycle and turn the Wash/Spin Speed dial to Delicate/Slow.

## Step 5 Pull Control Dial Out to Start

You may stop the washer at any time by simply pushing the control dial IN. Therefore it is possible to obtain a non-agitated soak or to shorten, skip or repeat any part of a cycle. The control dial must be pushed IN (off position) when you change the setting.

**Note: Do not attempt to turn the control dial counterclockwise. Damage to the timer will result.**

# Special Features

## 1. Liquid Bleach Dispenser

The dispenser automatically dilutes liquid chlorine bleach before it reaches your wash load. To use, follow these steps:

1. Measure liquid chlorine bleach carefully, following the instructions on the bottle.
2. Add the bleach to the dispenser before adding the load. Avoid splashing or over-filling the dispenser.

### NOTE:

- Never pour undiluted liquid chlorine bleach directly onto the load or into the wash tub. It is a powerful chemical and can cause fabric damage, such as tearing or color loss, if not used properly.
- If you prefer to use color-safe, non-chlorine bleach, pour it into the wash tub with your detergent. Do not pour non-chlorine bleaches into the bleach dispenser.

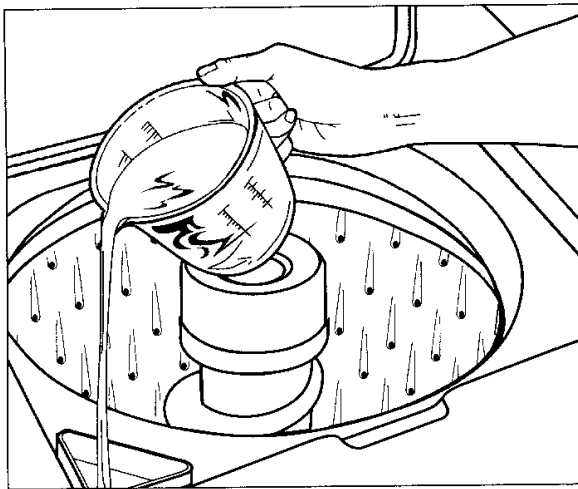

*Pour liquid chlorine bleach into bleach dispenser.*

## 2. Fabric Softener Dispenser

The dispenser automatically releases liquid fabric softener at the proper time during the cycle. To use, follow these steps:

1. Pour a measured amount of fabric softener into dispenser top to fill line only.
2. If fabric softener comes below line, add warm water.

If it is necessary to clean the dispenser, pull the fabric softener dispenser off of the agitator. Then hold the dispenser with both side up and twist to disengage dispenser bottom from top (see below). You are then able to clean both parts using warm water and a brush if necessary.

To reassemble, hold both pieces in an upright position. Insert the inner chamber into the outer chamber using the slots to position parts. Rotate until tabs snap into locking position.

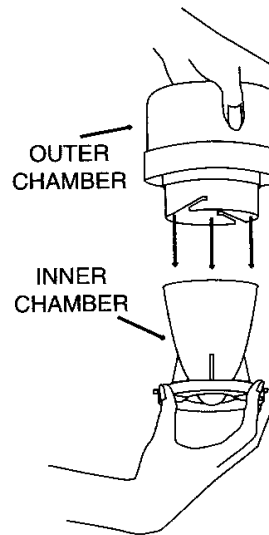
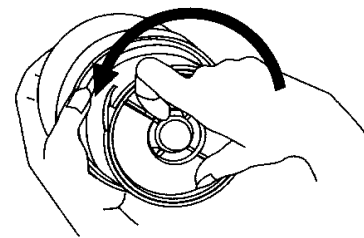
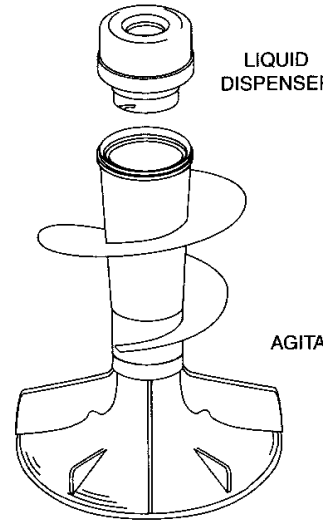

---

### 3. Automatic Lint Filtering System

*The Lint Filtering System does not require cleaning.*

Wash and rinse water is filtered and re-filtered continuously to trap lint shed by most fabrics during the agitation cycle before it can be re-deposited on the wash load. The engineered hole design on the wash basket in conjunction with water flow produced by the agitator, traps lint away from the clothes between the inner wash basket and the outer tub. Lint is automatically flushed from the washer during the spin cycle.

### 4. Safety Spin

If for any reason you open the washer lid when the washer is in a spin or extract period, the operation will immediately stop. This is for your personal safety. If your washer does not stop, call your service technician immediately. When the lid is closed, the operation will automatically resume.

### 5. Unbalanced Spin Load Compensator

Your new washer is designed to handle out-of-balance loads without shutting down or interrupting the washing cycle.

For this reason, the cycle will always be completed. If heavier fabrics in such out-of-balance loads should ever contain excessive moisture at the completion of the cycle, redistribute the clothes in the washer and reset the control dial for the final spin period.

### 6. Overload Protector

A built-in protector automatically shuts off the washer motor in case of an overload. This can occur if:

- The load being washed is too heavy.
- Too many appliances are plugged into the line operating your washer.
- A low voltage condition exists on the line.
- Lid is opened and closed repeatedly.

The overload protector permits the washer to start again when the motor has cooled to a safe operating temperature.

If the motor stops repeatedly, call your service technician.

---

## Care & Cleaning

1. After washing, leave the lid open until the interior is dry.
2. Check hoses to be sure there are no kinks or knots.
3. Your washer should not be installed where temperatures will go below freezing, as damage to the washer could result.
4. Occasionally wipe exterior with a clean damp sponge or cloth. Polish with a soft dry cloth. If desired, occasionally polish, being careful not to use polish on plastic parts.
5. Lifetime lubrication is done at the factory, so your washer never needs to be oiled or greased.
6. Do not lay heavy or sharp objects on top of your washer.
7. The top of the washer should not be used for removing stains from garments. Some stain removers, such as rust remover, will mar the finish.
8. Remove pins, buckles or other sharp objects from clothes to prevent scratching interior parts.
9. Clothes should not be stored in washer.
10. Bleach, detergent, solvents, etc. spilled on the top of your washer that are allowed to remain will remove the glossy finish. Remove all spills with a damp, soft cloth.
11. If you close your home for the winter, have a service technician drain the washer. Unplug cord from electrical outlet and disconnect hoses from faucets.

# Before You Call

## Check the following if your clothes washer...

### Won't Drain:

- Is the hose kinked or knotted?
- Is the drain outlet clogged?

### Does Not Fill:

- Is the electrical cord plugged in correctly?
- Has a fuse blown or is the circuit breaker tripped?
- Is the control dial pulled out?
- Are the hot and cold water faucets turned on?
- Are the hoses kinked or knotted?
- Is the control dial set properly (not in the off position)?
- Turn off, let stand for 30 minutes then restart. Motor thermal protector may have engaged.
- Hose filter screens may be plugged. Disconnect hoses and clean screens.

### Water Temperature Is Incorrect:

- Is the temperature switch set correctly?
- Are the hoses connected to the correct faucets (hot to hot, cold to cold)?
- Are the hot and cold faucets turned on?
- Is water heater set correctly?

### Is Noisy:

- Is the washer level and firm to the floor?

### Does Not Spin:

- Is the lid closed?
- Is the electrical cord plugged in correctly?
- Has a fuse blown or is the circuit breaker tripped?

### Is Leaking:

- Are the hose connections tight at the faucets?
- Is end of drain hose correctly inserted in and secured to drain facility?

*For further assistance contact Maytag Appliances Sales Company, Maytag Customer Assistance:  
U.S. 1-800-688-9900 or Canada 1-800-688-2002*

*U.S. customers using TTY for deaf, hearing impaired or speech impaired, call 1-800-688-2080.*



# **Performa by Maytag**

## **Clothes Washer Warranty**

### **FULL ONE-YEAR WARRANTY**

Any part which fails in normal home use during the first year after the date of original retail purchase will be repaired or replaced free of charge.

### **LIMITED WARRANTY**

After the first year from the date of original retail purchase, through the time periods listed below, the designated parts which fail in normal home use will be repaired or provided free of charge for the part itself, with the owner paying all other costs, including labor, mileage and transportation.

#### **Second Year through Tenth Year**

All parts of the transmission assembly

#### **Second Year through Lifetime**

The inner wash basket

The full warranty and the limited warranty apply when the appliance is located in the United States or Canada. Appliances located elsewhere are covered by the limited warranty only, including parts that fail during the first year.

This warranty gives you specific legal rights, and you may also have other rights that vary from state to state.

### **TO OBTAIN WARRANTY SERVICE**

To locate an authorized service company in your area contact the Maytag dealer from whom your appliance was purchased; or call Maytag Appliances Sales Company, Maytag Customer Assistance. Should you not receive satisfactory warranty service, please call or write:

Maytag Appliances Sales Company

Attn: CAIR® Center

P.O. Box 2370

Cleveland, TN 37320-2370

U.S. 1-800-688-9900

Canada 1-800-688-2002

U.S. Customers using TTY for deaf, hearing impaired or speech impaired, call 1-800-688-2080.

When contacting Maytag Appliances Sales Company, Maytag Customer Assistance about a service problem, please include the following:

- (a) Your name, address and telephone number;
- (b) Model number and serial number (found on the back center of the control panel) of your appliance;
- (c) Name and address of your dealer and the date the appliance was purchased;
- (d) A clear description of the problem you are having.
- (e) Proof of purchase.

### **What is not covered by these warranties:**

1. Conditions and damages resulting from any of the following:
  - a. Improper installation, delivery, or maintenance.
  - b. Any repair, modification, alteration or adjustment not authorized by the manufacturer or an authorized servicer.
  - c. Misuse, abuse, accidents or unreasonable use.
  - d. Incorrect electric current, voltage or supply.
  - e. Improper setting of any control.
2. Warranties are void if the original serial numbers have been removed, altered, or cannot be readily determined.
3. Products purchased for commercial or industrial use.
4. The cost of service or service call to:
  - a. Correct installation errors.
  - b. Instruct the user on proper use of the product.
  - c. Transport the appliance to the servicer.
5. Consequential or incidental damages sustained by any person as a result of any breach of these warranties.

Some states do not allow the exclusion or limitation of consequential or incidental damages, so the above exclusion may not apply.

User's Guides, service manuals and parts catalogs are available from Maytag Appliances Sales Company, Maytag Customer Assistance.