

TABLE OF CONTENTS

	Page
About Your Maytag	1
For Future Reference	1
Consumer Publications	1
Installation	2
General Features	3
Operating the Refrigerator	4
• Temperature Controls	4
• Energy Saver Switch	4
• Warm Cabinet Surfaces	4
Adjusting the Refrigerator and Freezer Interiors	5-6
• Refrigerator Interior	5
Sure-Lock Shelves	5
Door Bins	5
Keepers	5
• Freezer Interior	6
Freezer Shelves	6
Special Storage Areas	6-8
• Crispers	6
• Meat/Cheese Drawer	7
• Wine Rack	7
• Covered Dairy Compartment	7
• Egg Cradle	7
Energy Saving Tips	8
Food Storage Tips	8-11
• Fresh Food Storage	8-9
• Frozen Food Storage	9
• Food Storage Chart	10-11
Ice Service	12
• Twist Ice Cube Trays	12
• Automatic Ice Maker	12
Care and Cleaning	13-14
• Refrigerator Exterior and Interior	13
• Cleaning Under the Refrigerator	13
• Cleaning the Condenser	13
• Cleaning the Defrost Pan	13
• Replacing the Interior Lights	13
• Cleaning Chart	14
Non-Use Periods	15
• Vacations	15
• Moving	15
Important Personal Safety Instructions	15
To Avoid Unnecessary Service Calls	16
Warranty	17

ABOUT YOUR MAYTAG

Congratulations on your choice of a Maytag refrigerator! As you use your new refrigerator we know you will appreciate the many features that provide excellent performance, ease of cleaning, convenience and dependability.

It is important to understand how your new refrigerator operates before you use it. On the following pages you will find a wealth of information regarding all aspects of your refrigerator. By following the instructions carefully, you will be able to fully enjoy and properly maintain your Maytag refrigerator.

Should you have any questions about using your Maytag refrigerator contact us. Be sure to provide the model number of your refrigerator.

CONSUMER EDUCATION
MAYTAG
 ONE DEPENDABILITY SQUARE
 NEWTON, IOWA 50208
 (515) 791-8911
 (Mon.-Fri., 8 am-5 pm CST)

NOTE: For service and warranty information see pages 16-17.

FOR FUTURE REFERENCE

For future reference we suggest you retain this manual after recording the model number, serial number (six numbers and two letters) and bill of material number of this refrigerator in the spaces provided below.

This information can be found on the data sticker located at the top front interior of the refrigerator compartment. (See example below)

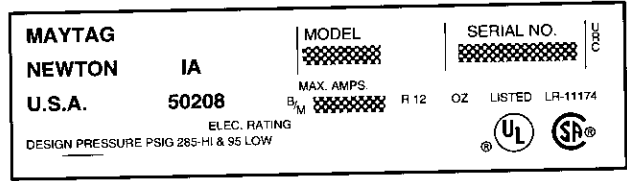

Model Number

Serial Number

Bill of Material Number

CONSUMER PUBLICATIONS

For more information about appliances, order the following items from Maytag at the prices indicated. Send your name, address, booklet title, form number and payment to: Consumer Education Dept., Maytag, One Dependability Square, Newton, IA 50208. Allow 4-6 weeks for delivery.

- Appliance Buying Guides50¢ EACH
- Washer — 211YG
- Dryer — 212YG
- Dishwasher — 213YG
- Electric Range — 214YG
- Gas Range — 215YG
- Refrigerator — 276YG
- Before You Call (avoiding unnecessary service calls) — 206YG50¢

INSTALLATION

Remove and discard cantilever shelf packing clips located just above each shelf where it hooks onto the frame. To remove plastic clips, wiggle the clips sideways and pull straight out.

Locating Your Refrigerator

1. Allow a free flow of air through the front base grille.
2. Your model should not be installed where the room temperature will go below 55 degrees F., because it will not run frequently enough to maintain proper temperature in the freezer.
3. For ease of installation, you should leave a space of about 1/2 inch between the refrigerator and adjacent walls or cabinets. If the refrigerator is placed with the hinge side against a wall, you may want to leave additional space so the door can be opened wider.

Important Leveling Information

Your refrigerator is equipped with front and back rollers so it can be moved away from the wall for cleaning. The front rollers are adjustable and should be positioned so the refrigerator sits firmly on the floor and is level.

To adjust the front rollers:

1. Remove the base grille by grasping the bottom edge near each end and pulling out (Figure 1).

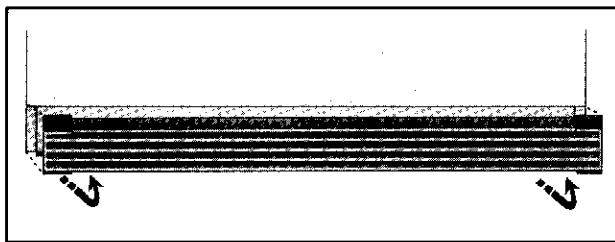

Figure 1.

2. Using a Phillips screwdriver, turn the roller adjusting screws clockwise to lower the cabinet; turn counterclockwise to raise (Figure 2).

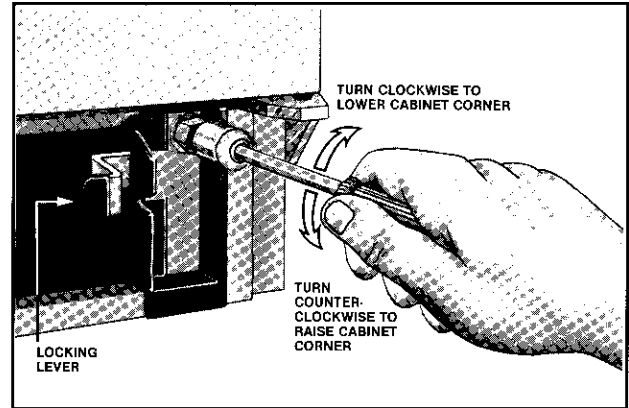

Figure 2.

3. Lock the rollers by lifting up the locking lever until the locking lever tab engages the roller tooth. It may be necessary to rock the refrigerator slightly for the tab to engage.
4. To replace the base grille, angle the top (wide portion) up and in. Push in on the bottom until it snaps into place.

Connecting the Appliance

WARNING: This appliance is designed to operate on a nominal 115 volt, 15 amp, 60 cycle line. There should be a separate, grounded circuit serving this appliance only. Do not use an extension cord.

This appliance is equipped with a three-pronged grounding plug for your protection against possible electrical shock hazards. It must be plugged into a grounding receptacle. Where a standard two-prong wall receptacle is encountered, it is the personal responsibility and obligation of the customer to have it replaced with a properly grounded three-prong wall receptacle. Do not under any circumstances, cut or remove the third (ground) prong from the power cord. Do not use an adapter plug.

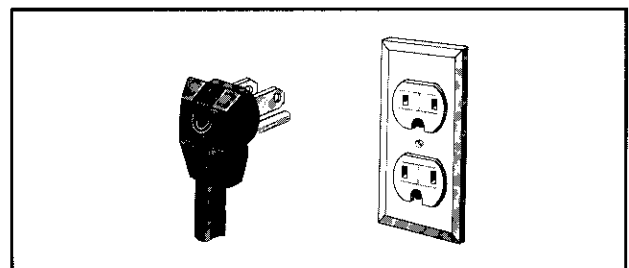

GENERAL FEATURES

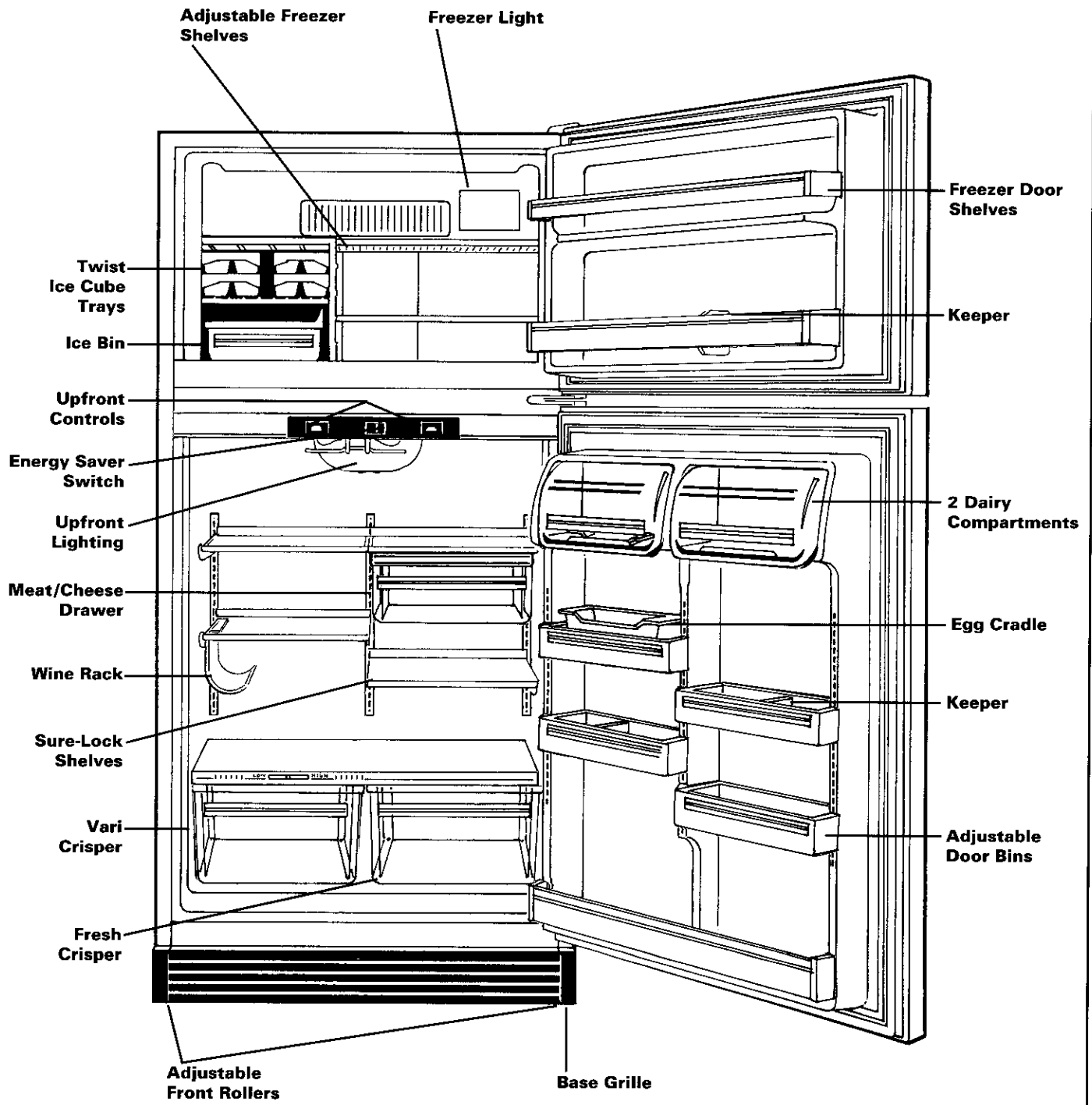

Features may vary according to model.

OPERATING THE REFRIGERATOR

Temperature Controls

Location of the Controls

Your new refrigerator has two controls: one for the refrigerator compartment and one for the freezer compartment. Both controls are up-front, located at the top front of the refrigerator compartment. To adjust the controls, grasp the underside of the control and turn.

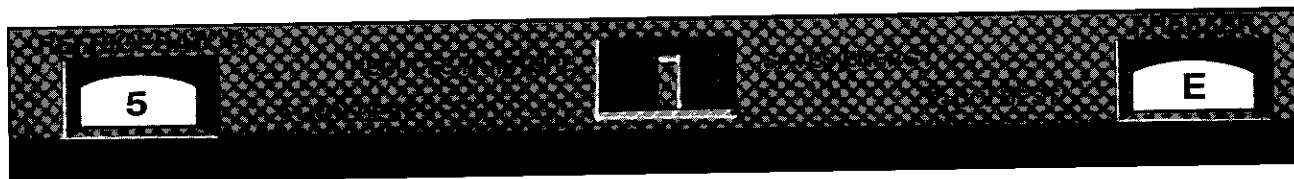

Initial Setting of the Controls

Refrigerator Control: This control has settings from 1 (warmest) to 9 (coldest). **Initially set this control to 5.** The refrigerator may run for several hours when you first start it. This is normal.

Freezer Control: This control has settings from A (warmest) to I (coldest). **Initially set this control to E.**

NOTE: The coldest freezer setting (I) is recommended for short term use only.

Let the refrigerator run at least 8 to 12 hours before adding food. A day or so after adding food, you may decide one or both compartments should be colder or warmer. If so, adjust the control(s) as instructed below.

Adjusting the Temperature Controls

Except when starting the refrigerator, **do not change either control more than one number or letter at a time.** Allow 24 hours for the temperature to stabilize before resetting. Changing either control will have some effect on the temperature of the other compartment.

Freezer too warm—Turn the freezer control to the succeeding letter. For example, turn the control from E to F.

Freezer too cold—Turn the freezer control to the preceding letter. For example, turn the control from E to D.

Refrigerator too warm—Turn the refrigerator control to the next higher number. For example, turn the control from 5 to 6.

Refrigerator too cold—Turn the refrigerator control to the next lower number. For example, turn the control from 5 to 4.

The Energy Saver Switch

This switch operates a heater that helps keep moisture from forming on the outside of the refrigerator.

To Use:

1. **Move the switch to the “Reduces Moisture” position only when moisture forms on the outside of the refrigerator. The red indicator light is on when the switch is in this position.**
2. Move the switch to the “Saves Energy” position when the humidity is low to save on the energy needed to operate the refrigerator.

Warm Cabinet Surfaces

Some portions of the cabinet may be warm to the touch. This is a normal function of the refrigerator which helps prevent moisture from condensing on the cabinet. This condition will be more noticeable when you first start your refrigerator, during hot weather and after excessive or lengthy door openings.

ADJUSTING THE REFRIGERATOR AND FREEZER INTERIORS

Refrigerator Interior

Sure-Lock Shelves

The refrigerator shelves are adjustable, allowing you to arrange the shelving to fit your family's food storage needs. **Never attempt to adjust a shelf that is loaded with food.**

To remove the refrigerator shelf:

1. Grasp the shelf at the front with one hand and push up under the shelf back with the other hand.
2. Pull the shelf straight out.

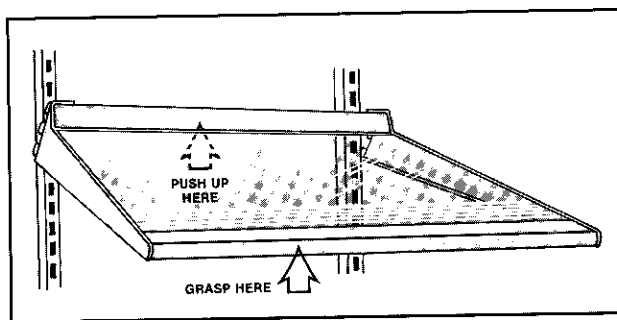

To replace the refrigerator shelf:

1. Keeping the shelf horizontal, guide the three support tabs into the slots in the shelf supports at the rear of the cabinet.
2. Lower the shelf until the tabs lock into position. Make sure the shelf is securely locked into position before loading it with food.

To position the Meat/Cheese drawer shelf:

The shelf that holds the Meat/Cheese drawer can be placed in one of three positions. When adjusting this shelf, remove the Meat/Cheese drawer and look at the back wall of the drawer frame. It is necessary for the air inlet tube at the back of the refrigerator to line up at the top, middle or bottom of the air slots in the back of the Meat/Cheese drawer frame for the temperature control to work properly. Set the temperature control to the coldest position when positioning the Meat/Cheese drawer. Once the shelf has been adjusted, replace the drawer and set the control to the desired setting (see page 7).

Door Bins

The pick-off refrigerator door bins are adjustable and can be easily removed. They are a complete bin, so items may be carried in the bin without falling out.

To remove the door bins:

Lift the bin straight up. Tip out the bottom of the bin and pull out the bin.

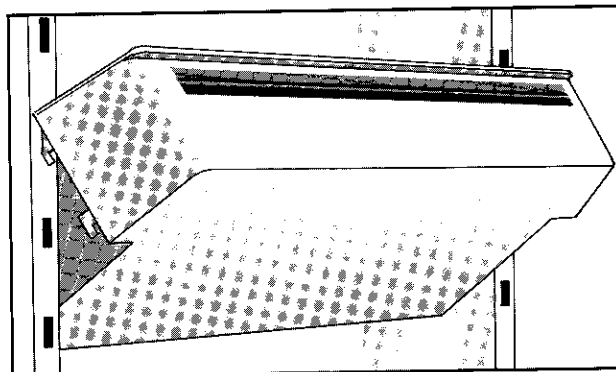

To replace the door bins:

Insert the top hooks first. Then push in and down.

Keepers

Some refrigerator door bins have "keepers" to secure bottles and containers. The keepers will help prevent items from tipping or falling when the door is opened and shut.

On adjustable door bins, lift the keeper slightly to slide from side to side. On fixed door bins, simply slide the keeper from side to side.

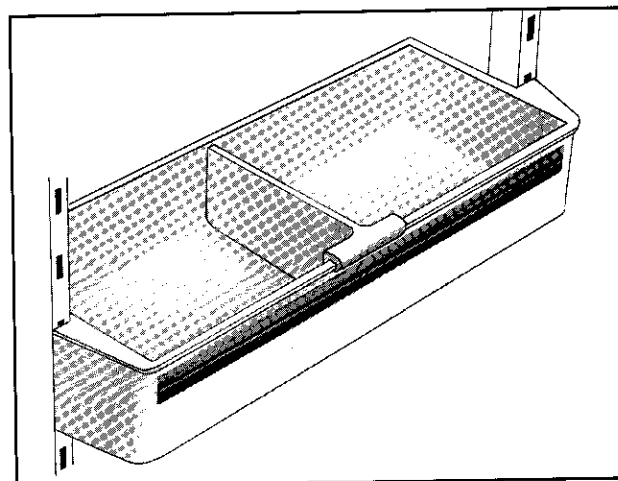

Freezer Interior

Freezer Shelves

The freezer shelves can be adjusted to any of four positions to accommodate the food load.

To remove the shelf:

1. Lift up on the shelf and push to the right.
2. Tilt the left side of the shelf up and remove.

To replace the shelf:

1. Tilt the shelf and insert the right rod ends into the upper portion of the oblong holes in the freezer wall.
2. Lower the left side of the shelf and insert into the oblong holes on the left side. Make sure the shelf is secure before loading.

SPECIAL STORAGE AREAS

Crispers

There are two types of crisper drawers in your Maytag refrigerator. The **Vari Crisper** allows the amount of moisture in the crisper to be controlled for storing either fruits or vegetables. The **Fresh Crisper** is ideal for storing vegetables.

Setting the Vari Crisper Control

Move the slide control to "Fruits" for a low moisture environment and to "Vegetables" for high moisture.

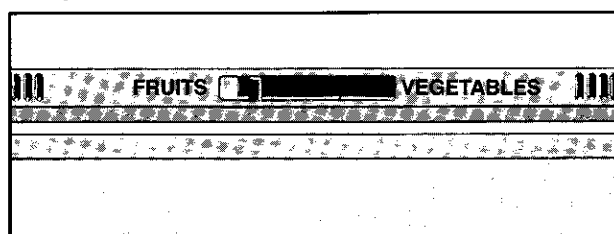

To remove the Crisper Drawers:

1. Pull out to the stop position.
2. Tilt up the drawer front and pull out.

To replace the Crisper Drawers:

1. Align the drawer rollers in the tracks.
2. Lift the drawer front and push in.

To remove the Crisper Shelf:

1. Remove the crisper drawers.
2. Remove the glass insert. Reach in from the underside and tilt up. Carefully remove the insert.
3. Lift the front of the crisper shelf and pull out. It may be necessary to remove the lower refrigerator shelves so the crisper shelf can be tilted for removal.

To replace the Crisper Shelf:

Reverse the procedure for removing the crisper shelf.

Meat/Cheese Drawer

Fresh meat, luncheon meat and cheese need to be stored in the coldest part of the refrigerator to maximize storage time. The **Meat/Cheese** drawer provides these colder temperatures because air from the freezer is directed around the drawer.

Setting the Temperature Control

To regulate the amount of cold air surrounding the Meat/Cheese drawer, move the temperature slide control. Set the slide control to the “Deli/Cheese” (right) position for storage of luncheon meat and cheese. Set the slide control to the “Fresh Meat” (left) position to provide the lowest temperature for fresh meat storage.

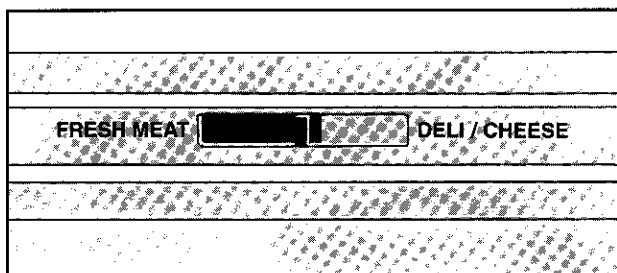

To remove the Meat/Cheese Drawer:

1. Pull out to the stop position.
2. Tilt up the drawer front and pull out.

To replace the Meat/Cheese Drawer:

1. Align the drawer rollers in the tracks.
2. Lift the drawer front and push in.

Wine Rack (select models)

Corked wines should be stored in a horizontal position to keep the cork wet. Storing wines upright for long periods allows the cork to dry out and shrink. This lets air into the wine and causes it to spoil. The wine rack lets you store wine properly without taking up valuable shelf space.

To use the wine rack, fit it along either side of any refrigerator shelf and lay the bottle on the rack. It may also be used for storing one liter containers of soda.

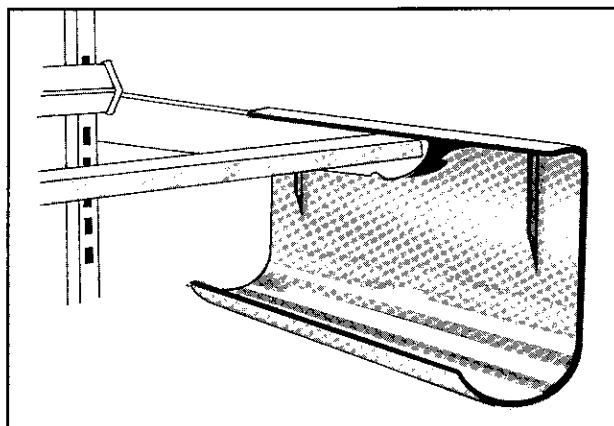

Covered Dairy Compartments

The butter dish is located in one of the covered dairy compartments. Use this area to store either butter or margarine or other dairy products. To use, raise the cover.

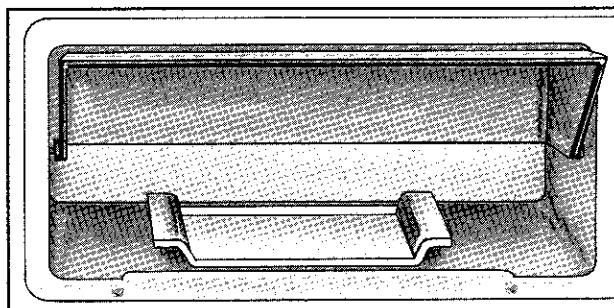

Egg Cradle

The egg cradle can be placed on a refrigerator shelf or stored in a door bin. It holds a “dozen-plus” eggs.

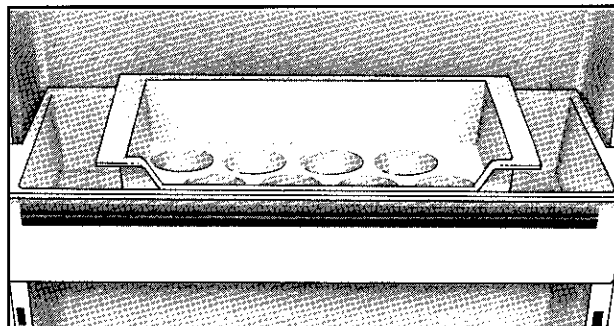

ENERGY SAVING TIPS

1. If possible, locate the refrigerator away from heat producing appliances such as the range or dishwasher, heat vents and direct sunlight.
2. Be sure the refrigerator is level and ventilation around the front grille is not blocked.
3. Keep the freezer full to near capacity so less cold air will escape during door openings. When less than two-thirds full, place milk cartons half full of water in the freezer.
4. Let hot dishes cool slightly before putting into the refrigerator or freezer.
5. Cover liquids; if uncovered, the refrigerator might run longer.
6. Clean the refrigerator condenser coils once a year (see page 13).
7. Wipe moisture from the outside of containers before placing them into the refrigerator.
8. Set the Energy Saver switch to the "Saves Energy" position unless moisture forms on the outside of the refrigerator.
9. Avoid opening the doors too often.

FOOD STORAGE TIPS

Fresh Food Storage

The fresh food compartment of a refrigerator should be kept between 34°F and 40°F with an optimum temperature of 37°F. To check the temperature, place an appliance thermometer in a glass of water and place in the center of the refrigerator. Check after 24 hours. If the temperature is above 40°F adjust the controls as explained on page 4.

Avoid overcrowding the refrigerator shelves. Overcrowding reduces the circulation of air around the food and results in uneven cooling. Leave breathing space around food containers for best cooling results.

The storage requirements for different foods vary depending on the temperature and moisture needed. **Refer to the Food Storage Chart on pages 10-11 for approximate storage times.** To maintain the best possible quality, keep the following considerations in mind:

Meat and Cheese

- To maximize storage time store these items in the Meat/Cheese drawer. Refer to page 7 for temperature settings.

Fruits and Vegetables

- Storage in the crisper drawers traps moisture to help keep fruits and vegetables fresh. The Vari Crisper allows the moisture level to be adjusted depending on what is stored in the crisper. Generally, fruits need low moisture and vegetables need high moisture. Refer to page 6 for setting the control.
- Fruit and vegetable quality affects the length of storage. Quality can vary from item to item, variety to variety and season to season. For example, a rainy growing season can cause lettuce to be brown when purchased or brown more quickly. Sort fruits and vegetables before storage and use bruised or soft items first. Discard those showing signs of decay.

- When storing vegetables, the crispers will perform better if they are at least two-thirds full. If they are less than two-thirds full, always store vegetables in plastic bags or airtight containers to reduce moisture loss.
- Always wrap odorous foods such as onions and cabbage so the odor does not transfer to other foods.
- While vegetables need a certain amount of moisture to remain fresh, too much moisture can shorten storage times (especially lettuce). Be sure the vegetables are well drained before storing. It may also be helpful to place a layer of paper towels in the bottom of the bag to absorb any excess moisture.

Dairy Food

- Store butter and margarine in the Dairy Compartments found in the refrigerator door.
- Most dairy foods such as milk, cream, sour cream and cottage cheese have freshness dates on their cartons for appropriate length of storage. Store these foods in the original carton and refrigerate immediately after purchasing and each use. Close carton lids tightly to keep out air and odors.
- Occasionally mold will develop on the surface of hard cheeses (Swiss, Cheddar, Parmesan). The moldy areas can be trimmed away and the remaining cheese will still be flavorful and safe to eat.

Frozen Food Storage

The freezer compartment of a refrigerator should be kept at 0°F or lower. To check the freezer, place an appliance thermometer between the frozen packages and check after 24 hours. A freezer operates more efficiently when it is at least two-thirds full. If not this full, it will be helpful to fill milk cartons half full of water and place them in the freezer.

Refer to the Food Storage Chart on pages 10-11 for approximate storage times. For the best results when freezing foods, follow these guidelines:

Packaging Foods for Freezing

- When freezing fruits and vegetables select fresh, top-quality products.
- Use a freezer wrap that is air-, moisture- and vapor-proof. Some good choices are heavy-duty aluminum foil, freezer plastic wrap, polyethylene-coated freezer paper, freezer bags or airtight containers. Force as much air out of the packages as possible and be sure they are tightly sealed. Trapped air can cause the food to dry out, change color and develop an off-flavor (freezer burn).
- Fresh meats and poultry can be left in the store wrapping when freezing for less than two weeks. For longer storage, overwrap with a suitable freezer wrap. Do not refreeze meat that has completely thawed.

Loading the Freezer

- Avoid adding too much warm food to the freezer at one time. This overloads the freezer, slows the rate of freezing and can raise the temperature of already frozen foods.
- Place the packages in the coldest part of the freezer first (against the walls or bottom of the compartment) to insure the food freezes as quickly as possible. Leave a little space between the packages so cold air can circulate.
- Avoid storing hard-to-freeze foods such as ice cream and orange juice on the freezer door shelves. These foods are best stored in the freezer interior where the temperature varies less with door openings.

Foods That Don't Freeze Well

- Some foods cannot be frozen successfully because the freezing causes them to deteriorate. These include:
 - potatoes (unless mashed)
 - cream fillings
 - cooked egg whites
 - sour cream
 - salad greens
 - luncheon meat
 - soft cheeses (cream, cottage, processed)
 - mayonnaise
 - milk and cream
 - gelatin salads
 - bananas
 - citrus fruits.

Food Storage Chart

The following chart shows approximate storage times* for various refrigerated and frozen foods. These storage times can vary depending on the type of packaging used and the storage temperatures.

Foods	Refrigerator Time	Freezer Time	Storage Tips
DAIRY PRODUCTS			
Butter	1-2 weeks	6-9 months	Store only enough for immediate use in the Dairy Compartment. Wrap tightly or cover.
Milk & cream	1 week	Not recommended	Check the carton dating. Close tightly. Don't return unused portions to original container. Don't freeze cream unless whipped.
Cream cheese, cheese spread & cheese food	1-2 weeks	Not recommended	Wrap tightly. Some cheese foods can be stored for longer periods.
Cottage cheese	5-7 days	Not recommended	Store in original carton. Check the carton dating.
Hard cheese (Swiss, Cheddar & Parmesan)	1-2 months	May become crumbly	Wrap tightly. Cut off mold if it develops on the surface.
Sour cream	10 days	Not recommended	Store in the original carton. Check the carton dating.
EGGS			
Eggs in the shell	1 week	Not recommended	Refrigerate small ends down.
Leftover yolks or whites	2-4 days	9-12 months	For each cup of yolks to be frozen, add 1 tsp. sugar for use in sweet, or 1 tsp. salt for non-sweet dishes.
FRESH FRUITS			
Ripening of fruits is slowed by refrigeration. Except where noted, store fruits in the Vari Crisper with the control on the "Fruits" setting.			
Apples	1 month	6-12 months	May also store unripe or hard apples at 60-70°F.
Bananas, pears & avocados	3-5 days	6-12 months	Ripen at room temperature before refrigerating. Bananas and avocados will darken when refrigerated.
Berries & cherries	2-3 days	6-12 months	Store covered or in the Vari Crisper to prevent moisture loss.
Citrus fruits	1-2 weeks	Not recommended	May also store at 60-70°F. If refrigerated, store uncovered.
Grapes	3-5 days	6-12 months	Store covered or in the Vari Crisper to prevent moisture loss.
Peaches, nectarines, plums & apricots	3-5 days	6-12 months	Ripen at room temperature before refrigerating.
Pineapples, cut	2-3 days	6-12 months	Will not ripen after purchase. Use quickly to avoid further deterioration.

Continued on next page

Food Storage Chart (continued)

Foods	Refrigerator Time	Freezer Time	Storage Tips
FRESH VEGETABLES			
Since vegetables remain fresh longest in a moist environment, they should be stored in the Fresh Crisper or in the Vari Crisper with the control on the "Vegetables" setting. If the crispers are full, store vegetables in plastic bags or plastic containers to prevent moisture loss.			
Asparagus	2-3 days	8-12 months	Don't wash before refrigerating. Store in the crisper.
Brussels sprouts & broccoli	3-5 days	8-12 months	Wrap odorous foods & refrigerate in the crisper.
Cabbage & celery	1-2 weeks	Not recommended	Wrap odorous foods & refrigerate in the crisper.
Cauliflower & snap beans	1 week	8-12 months	Wrap odorous foods & refrigerate in the crisper.
Carrots, parsnips, beets, radishes & turnips	2 weeks	8-12 months	Remove tops. Wrap odorous foods and refrigerate in the crisper.
Green peas & lima beans	3-5 days	8-12 months	Leave in pods & refrigerate.
Lettuce & other salad greens	1 week	Not recommended	Wash. Drain well. Refrigerate in the crisper.
Onions, green	3-5 days	8-12 months	Wrap odorous foods & refrigerate in the crisper.
Peppers & cucumbers	1 week	8-12 months	Wrap odorous foods & refrigerate in the crisper.
FRESH POULTRY & FISH			
Chicken	1-2 days	6-12 months	Can be kept in its original packaging for refrigeration. Place in the Meat/Cheese drawer with control on the "Fresh Meat" setting. When freezing longer than 2 weeks, overwrap with suitable freezer wrap.
Turkey, duck & goose	1-2 days	4-6 months	
Fish	1-2 days	1-2 months	
FRESH MEATS			
Beef, ground	1-2 days	4-6 months	Can be kept in original packaging for refrigeration. Place in the Meat/Cheese drawer with control on the "Fresh Meat" setting. When freezing longer than 2 weeks, overwrap with suitable freezer wrap.
Beef, roast & steak	3-5 days	9-12 months	
Pork	3-5 days	6-9 months	
Veal	3-5 days	4-6 months	
Sausage, ground	1-2 days	1-3 months	
Lamb	3-5 days	9-12 months	
PROCESSED MEATS			
Bacon	7 days	1 month	Processed meats should be tightly wrapped and stored in the Meat/Cheese drawer with the control on the "Deli/Cheese" setting.
Frankfurters	7 days	2 weeks	
Ham, whole	7 days	1-3 months	Unopened, vacuum-packed luncheon meat may be kept up to 2 weeks.
half slices	5 days	1-3 months	
	3 days	1-2 months	
Luncheon meat	3-5 days	Not recommended	
Sausage, smoked	7 days	Not recommended	

*Sources: United States Department of Agriculture; Food Marketing Institute; Cooperative Extension Service, Iowa State University

ICE SERVICE

Twist Ice Cube Trays

Your refrigerator comes equipped with twist ice cube trays and a storage bin. To release frozen cubes hold the trays upside down over the storage bin and twist both ends.

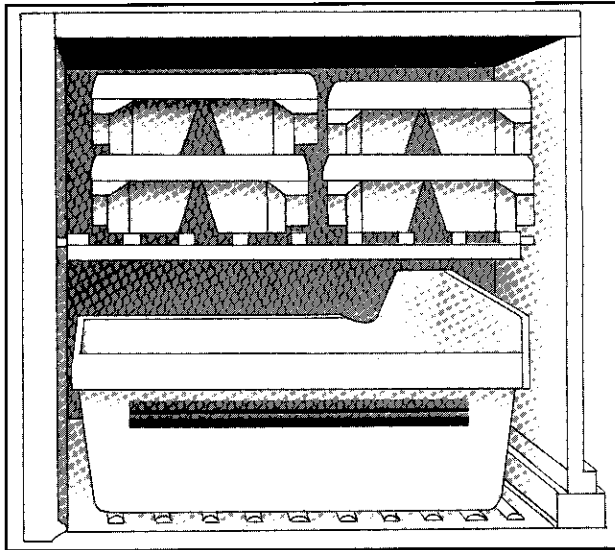

Automatic Ice Maker (select models)

If your refrigerator is equipped with an automatic ice maker, there are some things to keep in mind about its operation:

- After your refrigerator has been hooked up to the water supply, move the wire lever arm into the down position. This will start its operation. The ice maker will fill with water when the freezer reaches the proper temperature. With a newly installed refrigerator this could take up to 24 hours.
 - Discard all the cubes from the first two or three batches made. These initial batches of ice cubes may be irregular in shape and discolored.
 - When the ice cubes are ejected it is normal for several cubes to be joined together at the ends. They can easily be broken apart. The ice maker will continue to make ice until the supply of ice cubes raises the wire lever arm, shutting the ice maker off.
- To manually stop the operation of the ice maker, move the wire lever arm into the up position.
 - Certain sounds may accompany the various operating cycles of the ice maker:
 - buzzing of the water valve
 - running of the water as the tray fills
 - rattling of ice cubes falling into an empty ice bin
 - If the ice is not used frequently, the ice cubes will become cloudy, shrink, stick together and taste stale. Empty the ice storage bin periodically and wash it in lukewarm water. Be sure to dry the bin before replacing it.
 - To remove the ice bin, pull it forward, away from the ice maker. To avoid the ice maker dumping ice while the bin is removed, turn the ice maker off by lifting the wire lever.
 - To replace the ice bin, reverse the above procedure. Turn the ice maker on by lowering the wire arm.
 - Beverage and foods should **not** be placed in the ice storage bin for quick chilling. These items can block the wire lever arm, causing the ice maker to malfunction.

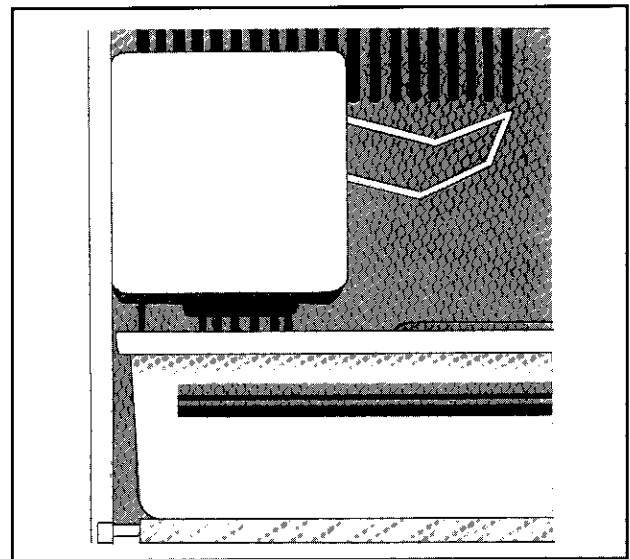

CARE AND CLEANING

Refrigerator Exterior and Interior

Refer to the chart on the next page when cleaning the refrigerator.

CAUTION: Disconnect the power cord before cleaning. Also, do not touch refrigerated surfaces with wet or damp hands. Damp objects stick to cold metal surfaces. Before cleaning the freezer, allow it to warm up. Allow glass shelves to warm up before immersing in warm water.

NOTE: The drain plug is located under the crisper drawers on the bottom of the refrigerator compartment. Pull straight up to remove. If it becomes clogged, remove and flush the drain line with baking soda and hot water. This water will drain into the defrost pan. (See below for cleaning the defrost pan.)

Cleaning Under the Refrigerator

Your refrigerator can be rolled out for cleaning the floor underneath. Simply unlock the front roller locks (see page 2). Pull the refrigerator straight out from the wall.

Cleaning the Condenser

The area around the condenser should be cleaned once a year for efficient operation. To do so, first unplug the refrigerator. Then thoroughly vacuum the dirt and lint from the front and open end of the condenser. The condenser can be reached through the right front base opening. See page 2 for removing the base grille.

Cleaning the Defrost Pan

The defrost water drains into a shallow pan beneath the cabinet and evaporates. This pan should be cleaned periodically with warm sudsy water.

To remove the defrost pan:

1. Remove the base grille (see page 2).
2. Lift the pan up and pull out.

To replace the defrost pan:

1. Position the side flanges to fit over the slide rails and press down on the center of the pan to snap in place.
2. Replace the base grille.

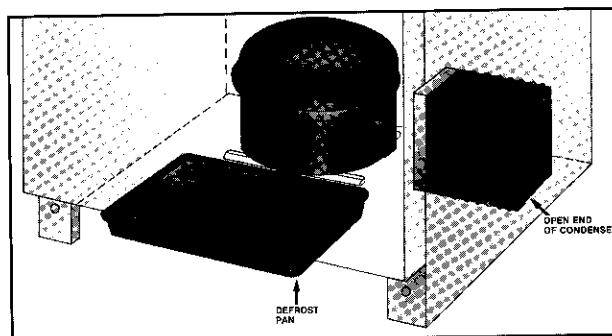

Replacing the Interior Lights

CAUTION: Disconnect the power cord before replacing light bulb(s). Wear gloves as protection against possible broken glass.

Refrigerator

The refrigerator lights are located directly behind the temperature controls.

To replace the refrigerator bulb(s):

1. Unplug the refrigerator.
2. Unscrew the bulb and replace with a 40 watt appliance bulb.

Freezer

The freezer light is located in the upper portion of the freezer compartment.

To replace the freezer bulb:

1. Unplug the refrigerator.
2. Using two hands, spread each side of the light cover outward and pull to the front to remove.
3. Unscrew the bulb when cool and replace it with a standard 40 watt appliance bulb.
4. Push the right side of the light cover toward the back of the freezer, engaging the tab in the slot. Then push the left side toward the back, engaging the left tab in the slot.

Refrigerator Cleaning Chart

Cleaning Agents*

Many different cleaning agents are recommended for the various parts of Maytag refrigerators. The following brand names may help you make an appropriate selection:

1. Mild abrasive cleaners such as Bon Ami, Soft Scrub, Bar Keepers Friend, Cameo.
2. Mild liquid sprays such as Fantastik, Formula 409.
3. Glass cleaner such as Windex, Glass Plus.
4. Appliance wax such as Jubilee.
5. Cleanbright #27 Liquid Ebony

DO NOT USE abrasive cleansing powders such as Comet or Zud, soap-filled scouring pads like S.O.S. or Brillo **except when indicated.** See pages 5-7 on how to remove and replace specific parts.

Refrigerator Exterior		
Part	Cleaning Agents	Tips and Precautions
Base grille	Soap and water Mild liquid sprays Vacuum cleaner attachment	To remove grasp the bottom edge near each end and pull out. To replace, angle the top (wide portion) up and in. Push in on the bottom until it snaps into place.
Condenser	Vacuum cleaner attachment	The area around the condenser should be cleaned at least once a year for efficient operation. See page 13 for more information.
Defrost pan	Soap and water	See page 13 on how to remove and replace.
Door handles	Soap and water Mild liquid sprays	
Painted metal surfaces: Cabinet, doors	Soap and water Mild liquid sprays Appliance wax	Wax at least once a year. Do not wax plastic or vinyl parts.
Black decorator panels	Glass cleaners Soft, clean, lint-free cloth (cotton diaper or cheesecloth) Cleanbright #27 Liquid Ebony	The following glass cleaners clean these panels best without streaking: Glass Plus, S.O.S. Glass Cleaner, The Works Glass Cleaner and Glassmates Wipes*. Do not use paper towels or soiled cloths because panels can scratch easily. To remove minor scratches, use Liquid Ebony according to instructions given on Maytag Fact Sheet (Form No. 266YG), available at no charge.
Refrigerator & Freezer Interior		
Door gasket	Baking soda and water Soap and water	Use 1-2 tablespoons baking soda per quart of water. Be sure to wring out excess water from sponge or cloth when cleaning around controls, lights, or electrical parts.
Glass shelves	Soap and water Glass cleaner Mild liquid sprays Mild abrasive cleaners	Allow the glass to warm up to room temperature before immersing in warm water. Never use hot water.
Interior and door liner	Soap and water Baking soda and water	See above for baking soda solution. DO NOT use abrasive cleaners, concentrated detergents, bleaches, cleaning waxes, solvents or polish cleaners to clean the refrigerator interior.
Crispers, door bins, egg cradle, wine rack, meat/cheese drawers, etc.	Soap and water	
Wire shelves/baskets	Soap and water Mild liquid sprays.	

*Brand names of cleaning agents are trademarks of the respective manufacturers.

NON-USE PERIODS

Vacations

If you will be gone for a month or less, leave the controls at the usual settings.

During longer absences:

- a) remove all food,
- b) shut off the ice maker (if installed) and the valve where you tapped into the water line to supply the refrigerator,
- c) disconnect the refrigerator from the electrical outlet,
- d) clean and dry the refrigerator thoroughly including the defrost pan,
- e) leave the doors open to prevent odors.

Moving

When moving, follow steps a–d under Vacations. In addition, remove and carefully pack any items that are easily removable. Ship the refrigerator in an upright position with the doors taped shut.

IMPORTANT PERSONAL SAFETY INSTRUCTIONS

1. To prevent possibility of hazard due to electrical shock, never plug the refrigerator into a receptacle which has not been grounded adequately and in accordance with the local and national electrical codes. See the grounding instructions on page 2.
2. Unplug the refrigerator before cleaning the condenser or replacing a light bulb.
3. In case of power failure, minimize door openings. If the power failure is of a long duration, protect the food by placing blocks of dry ice on top of the packages or check with a local frozen foods locker plant about temporary storage. Frozen foods which have thawed completely should not be refrozen.
4. Any electrical service cord that becomes frayed or damaged should be immediately repaired or replaced. Never unplug your appliance by pulling on the power cord.
5. Your refrigerator should not be operated in the presence of explosive fumes.
6. Remove the doors from any out-of-use refrigerator to prevent child entrapment and suffocation.
7. Children should not climb, hang or stand on the shelves of this refrigerator.

TO AVOID UNNECESSARY SERVICE CALLS . . .

Before calling a service technician, check the following list for possible troubles that you can remedy without difficulty.

<p>The refrigerator won't run</p>	<ul style="list-style-type: none"> • the temperature control turned to "Off" • the power cord not plugged in • no power at the electrical cord • the circuit breaker tripped or the house fuse blown
<p>The refrigerator runs too long/too frequently</p>	<ul style="list-style-type: none"> • modern refrigerators are larger and run colder, which requires more running time to provide more stable temperatures • the condenser needs cleaning (see page 13) • the control(s) set too cold • prolonged door openings • the base grille blocked • too many door openings • the door not sealing (due to a package or a container holding door open)
<p>Noisy operation <i>NOTE:</i> Additional motors and controls are used to provide improved performance. Therefore, normal operating sounds may be more noticeable than on the model it replaced.</p>	<ul style="list-style-type: none"> • fan noise — normal air flow • the defrost pan not positioned correctly • the cabinet not level • a weak floor
<p>Odor in the cabinet</p>	<ul style="list-style-type: none"> • odor producing foods should be covered or wrapped • the interior needs cleaning • the defrost pan needs cleaning
<p>Warm air from the cabinet bottom</p>	<ul style="list-style-type: none"> • normal air flow for condenser
<p>The cabinet vibrates</p>	<ul style="list-style-type: none"> • the cabinet not level • a weak floor
<p>Water on the floor under the cabinet</p>	<ul style="list-style-type: none"> • the defrost pan missing or not positioned properly
<p>Foods dry out</p>	<ul style="list-style-type: none"> • the packages not wrapped or sealed properly • the crisper not tightly closed
<p>The cabinet light not working</p>	<ul style="list-style-type: none"> • the bulb burned out • no power at the outlet
<p>The refrigerator compartment too warm</p>	<ul style="list-style-type: none"> • the refrigerator control set too warm • prolonged door openings
<p>The refrigerator compartment too cold</p>	<ul style="list-style-type: none"> • the refrigerator control set too cold
<p>The freezer compartment too warm</p>	<ul style="list-style-type: none"> • the freezer control set too warm • prolonged door openings
<p>Sizzling sound in the freezer</p>	<ul style="list-style-type: none"> • a normal sound caused by defrost water dripping on defrost mechanism
<p>Moisture collects on the outside surface</p>	<ul style="list-style-type: none"> • hot humid weather increases condensation, move energy saver switch to "Reduce Moisture" position
<p>The ice cubes evaporate</p>	<ul style="list-style-type: none"> • cold air moving over the ice cubes when not used regularly
<p>The automatic ice maker not operating (optional)</p>	<ul style="list-style-type: none"> • the stop arm in OFF (up) position • the water supply turned off • the water pressure too low • the freezer too warm

If after checking the list, the appliance still doesn't seem to operate properly, call your Maytag dealer's service department or the service department recommended.

REFRIGERATOR WARRANTY

Full One Year Warranty

For **one (1) year** from the date of original retail purchase, any part which fails in normal home use will be repaired or replaced free of charge.

Limited Warranty

Second thru Fifth Year — major refrigeration components:

After the first year and through the fifth year after the date of original retail purchase Maytag will repair or replace, at its option, free of charge to the owner for parts and labor any part of the sealed refrigeration system (consisting of the compressor, evaporator, condenser, drier and connecting tubing) and the cabinet liner (exclusive of the door liner) which fails in normal home use. Trip charges, travel and transportation, if required, shall be the responsibility of the owner.

Second Year — other parts:

Other parts which fail in normal home use during the second year following date of original retail purchase will be repaired or replaced free of charge for the part itself, with the owner paying all other costs, including labor and trip charges.

Ice Maker – when purchased with the refrigerator and installed by the dealer the ice maker will be considered part of the refrigerator for warranty purposes.

This full warranty and the limited warranty apply only when the appliance is located in the United States or Canada.

LIMITATION OF LIABILITY

Maytag shall not be liable for any incidental or consequential damages, including food loss. Some states do not allow the exclusion or limitations of consequential damages, so the above limitations or exclusion may not apply to you.

This Warranty gives you specific legal rights, and you may also have other rights which vary from state to state.

To Receive Warranty Service

First: To locate an authorized service company in your area, contact the Maytag dealer from whom your appliance was purchased or call Maytag Customer Service:

US 1-800-688-9900

CANADA 1-800-688-2002

or check in your telephone directory yellow pages.

Second: Should you not receive satisfactory warranty service from the dealer or authorized service firm, or need further assistance, call or write:

Maytag Customer Service

P.O. Box 2370

Cleveland, TN 37311

US 1-800-688-9900

CANADA 1-800-688-2002

When contacting Customer Service be sure to provide the model and serial number of your appliance, the name and address of the dealer from whom you purchased the appliance, and the date of purchase.

Should you still have a problem, write to: Major Appliance Consumer Action Panel, 20 North Wacker Drive, Chicago, Illinois 60606. MACAP is an industry sponsored but independent group of consumer experts who receive and act on complaints from appliance owners.

NOTE: When writing about an unsolved service problem, please include the following information:

- (a) Your name, address and telephone number;
- (b) Model number, serial number, and bill of material number (found on the top front interior of the refrigerator compartment);
- (c) Name and address of your dealer and the date the appliance was bought;
- (d) A clear description of the problem you are having.