

# ABOUT YOUR NEW GAS WALL OVEN

Congratulations on your choice of this appliance. As you use your new wall oven, we know you will appreciate the many features that provide excellent performance, ease of cleaning, convenience and dependability.

New features have dramatically changed today's cooking appliances and the way we cook. It is therefore very important to understand how your new gas wall oven operates BEFORE you use it for the first time.

In this Owner's Guide, you will find a wealth of information regarding all aspects of your appliance. By following the instructions carefully, you will be able to fully enjoy and properly maintain your new wall oven.

In our continuing effort to improve the quality of our cooking products, it may be necessary to make changes to the

appliance without revising this booklet. As an example, the knob on your appliance may not look like the illustration in this book.

Should you have any questions about using your new gas appliance, please write to us at this address:

MAYTAG CUSTOMER SERVICE  
Customer Assistance  
P.O. Box 2370  
Cleveland, TN 37320-2370

Be sure to include the model and serial numbers of your wall oven. For your convenience, we have provided space below to record this information.

## IMPORTANT INFORMATION

For future reference we suggest you retain this manual after recording the information in the spaces provided. **This information can be found on the rating data plate located under the broiler oven bottom. See page 10 for instructions on removing the broiler bottom.**

MODEL NUMBER:

\_\_\_\_\_

SERIAL NUMBER:

\_\_\_\_\_

DATE OF PURCHASE:

\_\_\_\_\_

**IMPORTANT:** Retain the proof of purchase documents for warranty service.

DEALER FROM WHOM PURCHASED:

\_\_\_\_\_

ADDRESS: \_\_\_\_\_

CITY: \_\_\_\_\_

PHONE: \_\_\_\_\_

AUTHORIZED SERVICER:

\_\_\_\_\_

ADDRESS: \_\_\_\_\_

CITY: \_\_\_\_\_

PHONE: \_\_\_\_\_

# IMPORTANT SAFETY INSTRUCTIONS

1

Read all instructions before using this appliance. The following instructions are based on safety considerations and must be strictly followed to eliminate the potential risks of fire, electric shock, or personal injury.

**WARNING:** If the information in this manual is not followed exactly, a fire or explosion may result causing property damage, personal injury or death.

- Do not store or use gasoline or other flammable vapors and liquids in the vicinity of this or any other appliance.
- **WHAT TO DO IF YOU SMELL GAS:**
  - Do not try to light any appliance.
  - Do not touch any electrical switch; do not use any phone in your building.
  - Immediately call your gas supplier from a neighbor's phone. Follow the gas supplier's instructions.
  - If you cannot reach your gas supplier, call the fire department.
- Installation and service must be performed by a qualified installer, service agency or the gas supplier.

## GENERAL SAFETY

**CAUTION:** Some cabinets and building materials are not designed to withstand the heat produced by the normal, safe operation of a cooking appliance. Discoloration or damage, such as delamination, may occur. Therefore, **care should be given to the location of this appliance.**

- Be sure all packing materials are removed from the appliance before operating it to prevent fire or smoke damage should the packing material ignite.
- Have your appliance installed and properly grounded by a qualified installer, in accordance with the Installation Instructions. Any adjustment or service should be performed only by a qualified installer or servicer.
- Have the installer show you the location of the gas shut off valve and how to shut it off in an emergency.

No cooking appliance should be used as a space heater to heat or warm a room. This instruction is based on safety considerations to prevent potential hazard to the consumer as well as damage to the appliance.

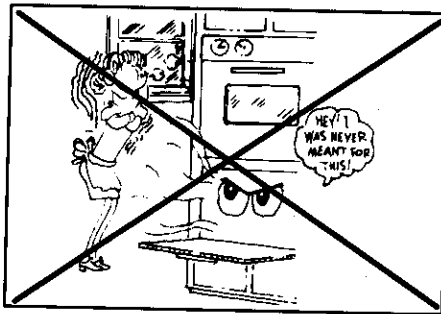

- Don't attempt to repair or replace any part of your appliance unless it is specifically recommended in this book. All other servicing should be referred to a qualified servicer.
- Always disconnect power to appliance before servicing.
- If appliance is installed near a window, proper precautions should be taken to prevent curtains from blowing over burners creating a FIRE HAZARD.
- Keep area around appliance clear and free from combustible

materials, gasoline, and other flammable vapors and materials.

- Many aerosol-type spray cans are **EXPLOSIVE** when exposed to heat and may be highly flammable. Avoid their use or storage near an appliance.

## ABOUT YOUR APPLIANCE

- Your appliance is vented through the base of the control panel. **Never block oven vent or air intakes. Do not obstruct the flow of combustion and ventilation air.** Restriction of air flow to the burner prevents proper performance.

Avoid touching oven vent area while oven is on and for several minutes after oven is turned off. Some parts of the vent and surrounding area become hot enough to cause burns.

- Do not use the oven as a storage area for food or cooking utensils. This instruction is based on safety considerations to prevent potential hazard to user and to the appliance.
- Misuse of appliance doors, such as stepping, leaning or sitting on the door, may result in possible tipping of the appliance, breakage of door, and serious injuries.

**CAUTION:** Do not use an appliance as a step stool to cabinets above.

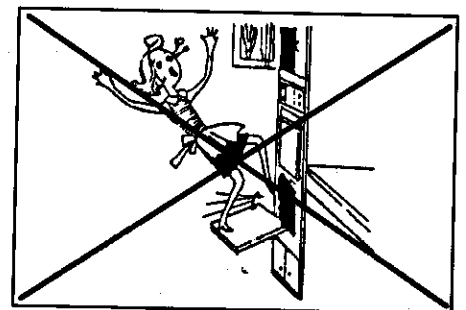

- Temperatures in storage areas above the appliance may be unsafe for some items, such as volatile liquids, cleaners or aerosol sprays.

**CLEANING SAFETY:**

- Turn off all controls and wait for appliance parts to cool before touching or cleaning them.
- Clean appliance with caution. If a wet sponge or cloth is used to wipe spills on a hot cooking area, be careful to avoid steam burns. Some cleaners can produce noxious fumes if applied to a hot surface.
- Touching a hot oven light bulb with a damp cloth could cause the bulb to break. Should the bulb break, disconnect power to the oven before trying to remove the bulb to avoid electrical shock.

**COOKING SAFETY:**

- Never heat an unopened container in the oven. Pressure build-up may cause container to burst resulting in serious personal injury or damage to the oven.
- Always place oven racks in the desired positions while oven is cool. If a rack must be moved while hot, be careful to avoid contact of pot holders with oven burner flame.
- Slide oven rack out to add or remove food, using dry, sturdy pot holders. Always avoid reaching into oven to place or remove food.
- Use dry, sturdy pot holders. Damp pot holders may cause burns from steam. Dish towels or other substitutes should never be used as pot holders because they can ignite or get caught on appliance parts.
- Use care when opening oven door. Let hot air or steam escape before removing or replacing food.
- Use caution when wearing garments made of flammable material to avoid clothing fires. Loose fitting or long hanging-sleeved apparel should not be worn while cooking. Clothing may ignite or catch utensil handles.
- Do not let cooking grease or other flammable materials

accumulate in or near the appliance.

- In the event of a grease fire do not attempt to move pan.

If a grease fire occurs in the oven or in the broiler pan, turn oven off and keep door closed to contain fire until it extinguishes.

**Do not use water on grease fires.** Never pick up a flaming pan. Turn off burner, then smother flaming pan by covering pan completely with a lid, cookie sheet or flat tray. Or, extinguish flame by covering with baking soda or, if available, a multi-purpose dry chemical or foam-type fire extinguisher.

**Spills or boilovers which contain grease should be cleaned up as soon as possible.** If they are allowed to accumulate, they could create a FIRE HAZARD.

**PREPARED FOOD WARNING:**

- Follow food manufacturer's instructions. If a plastic frozen food container and/or its cover distorts, warps, or is otherwise damaged during cooking, immediately discard the food and its container. The food could be contaminated.

**UTENSIL SAFETY:**

- Use pans with flat bottoms and handles that are easily grasped and stay cool. Avoid using unstable, warped, easily tipped or loose handled pans. Do not use pans if their handles twist and cannot be tightened. Pans that are heavy to move when filled with food may also be hazardous.
- Many plastics are vulnerable to heat. Keep plastics away from parts of the appliance that may become warm or hot.
- When using oven cooking bags in oven, follow the manufacturer's directions.
- Use only glass cookware that is recommended for use in the oven.

**IMPORTANT SAFETY NOTICE AND WARNING**

The California Safe Drinking Water and Toxic Enforcement Act of 1986 (Proposition 65) requires the Governor of California to publish a list of substances known to the State of California to cause cancer or reproductive harm, and requires businesses to warn customers of potential exposures to such substances.

Users of this appliance are hereby warned that the burning of gas can result in low-level exposure to some of the listed substances, including benzene, formaldehyde and soot, due primarily to the incomplete combustion of natural gas or liquid petroleum (LP) fuels. Properly adjusted burners will minimize incomplete combustion. Exposure to these substances can also be minimized by properly venting the burners to the outdoors.

**CHILD SAFETY:**

- Do not leave children alone or unsupervised near the appliance when it is in use or is still hot.

Children should never be allowed to sit or stand on any part of the appliance.

Children must be taught that the appliance and utensils in it can be hot. Let hot utensils cool in a safe place, out of reach of small children.

Children should be taught that an appliance is not a toy.

Children should not be allowed to play with controls or other parts of the unit.

**CAUTION:** Do not store items of interest to children in cabinets above an appliance or on the backguard of a appliance. Children climbing on the appliance to reach items could be seriously injured.

**SAVE THESE INSTRUCTIONS**

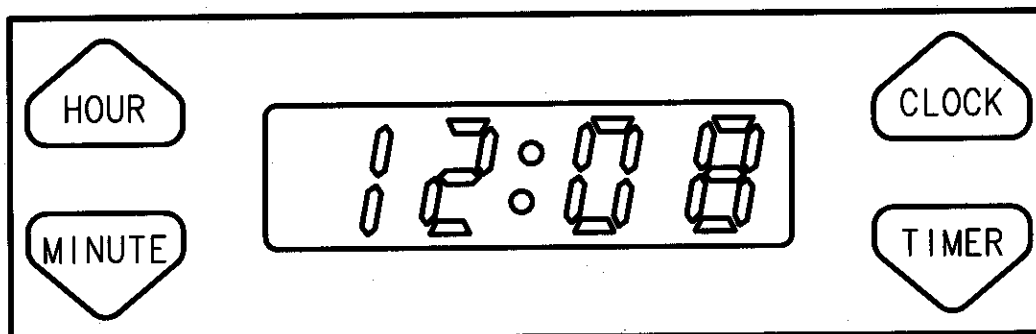

The display will flash when the wall oven is first connected to power or if power is interrupted. The display will stop flashing once the time-of-day clock has been set.

### To set the time-of-day clock:

1. Press the CLOCK pad.
2. Press and hold the HOUR pad to set the correct hours. To change the time by a single hour, give the pad a short tap.
3. Press and hold the MINUTE pad to set the correct minutes. To change the time by a single minute, give the pad a short tap.

For example: To set the clock for 3:15, press and hold the HOUR pad until 3 appears in the hours display. Then press and hold the MINUTE pad until 15 appears in the minutes display.

### To set the timer:

1. Press the TIMER pad. 0:59 (or one hour) will appear in the display.  
The timer will automatically begin counting down in increments of one minute.
2. To set the timer for less than one hour, press the TIMER pad then press and hold the MINUTE pad until the desired time appears in the display. To change the time by a single minute, give the pad a short tap.
3. To set the timer for more than one hour, press the TIMER pad then -
  - Press the HOUR pad, 1:59 (or two hours) will appear in the display.
  - Press the MINUTE pad until the desired minutes appear in the display.

NOTE: Two hours is the maximum time that can be set.
4. When the time has elapsed, 0:00 will appear in the display and continuous beeps will sound indicating the timer has counted down.
5. Press the CLOCK pad to cancel the beeps. The current time of day will reappear in the display.

**To cancel the timer:** Press the CLOCK pad and the display will return to the current time of day.

## OVEN CHARACTERISTICS

Every oven has its own characteristics. You may find that the cooking times and temperatures you were accustomed to with your previous appliance may need to be altered slightly with your new appliance. It is normal to notice some differences in cooking results between this new appliance and your previous appliance.

## PILOTLESS IGNITION

With this type of ignition system, the oven will not operate during a power failure or if the oven is disconnected from the wall outlet. **No attempt should be made to operate oven during a power failure or if the oven is disconnected from the wall outlet.**

## OVEN VENT

The oven vent is located at the base of the control panel. When the oven is in use, this area may feel warm or hot to the touch. To prevent problems, do not block the vent opening or touch the area near the opening.

## OVEN BURNER

The size and appearance of a properly adjusted oven burner flame should be as shown:

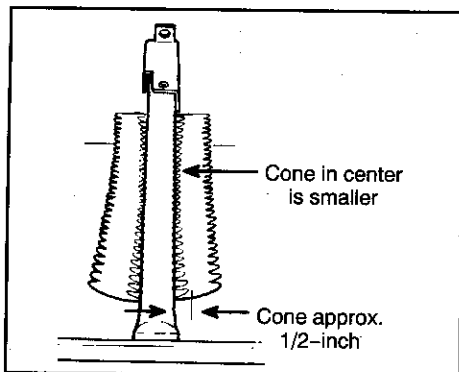

## OVEN THERMOSTAT

Be sure oven thermostat knob is set in the OFF position prior to supplying gas to the appliance.

The oven thermostat knob is used to select and maintain the oven temperature. The oven temperature is maintained by cycling the burner on and off. After the oven temperature has been set, there will be about a 45 second delay before the burner ignites. This is normal and no gas escapes during this delay.

Always push in and turn the thermostat knob just to the desired temperature – not to a higher temperature and then back. This provides more accurate oven temperatures. Turn this knob to OFF whenever the oven is not in use.

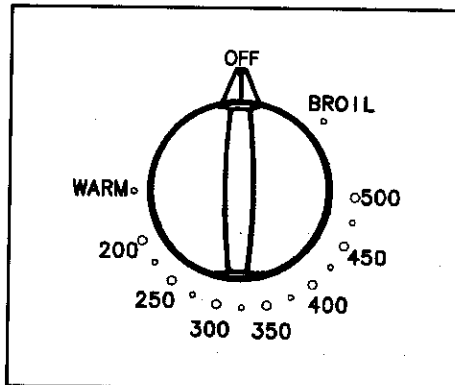

During some extended oven cooking operations, you may hear a "popping" sound when the burner cycles off. This is a normal operating sound of the burner.

## HOW TO SET THE OVEN

1. When cool, place the racks in the desired rack positions.
2. Push in and turn the oven thermostat knob to the desired oven temperature. Allow the oven to preheat for 10 to 15 minutes when baking.
3. Place the food in the center of the oven, allowing a minimum of two inches between the utensil(s) and the oven walls.
4. Check the food for doneness at the minimum time given in the recipe. Cook longer if necessary. Opening the oven door frequently causes heat loss which may affect cooking results and increase cooking time.
5. Turn the oven thermostat knob to OFF and remove food from the oven.

**NOTE:** The oven can not be used during a power failure or if the oven is disconnected from power supply.

## PREHEATING

Preheating is necessary for proper baking results. Allow the oven to heat until the desired oven temperature is reached, approximately 10 to 15 minutes. Selecting a temperature higher than the desired temperature will not preheat the oven any faster. In fact, this may have a negative effect on baking results.

It is not necessary to preheat for broiling unless darker browning is desired or if cooking thin (3/4-inch) steaks. Allow the burner to preheat 2 to 3 minutes.

Preheating is not necessary for roasting operations.

## OVEN RACKS

The two oven racks are designed with a lock-stop position to keep the racks from coming completely out of the oven.

Do not attempt to change the rack positions when the oven is hot.

**To remove:** Be sure the rack is cool. Pull the rack straight out to the lock-stop position. Tilt the front of the rack up and continue pulling the rack out of the oven.

**To replace:** Place the rack on the rack supports. Tilt the front end up and slide it back until it clears the lock-stop position. Lower the front and slide the rack straight in. Pull the rack out to the lock-stop position to be sure it is positioned correctly. Then return it to its normal position.

### Rack Positions

Use the following guidelines when selecting the proper rack positions:

**RACK 4** (top of oven) used for some two rack cooking or baking operations.

**RACK 3** used for one or two-rack baking.

**RACK 2** used for most one-rack baking, and roasting some meats.

**RACK 1** used for one or two-rack baking; roasting large meats; cooking larger foods or casseroles and for baking angel food cake, pie shells, cake or cakes in tube or bundt pans.

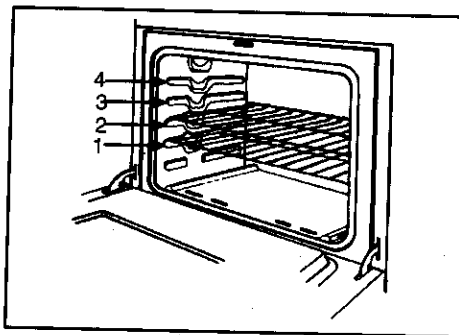

### Hints:

For optimum baking results of cakes, cookies or biscuits, bake on **one rack**. Position rack so food is in the center of the oven. Allow 2 inches between the edge of the utensil and the oven walls or adjacent utensils.

If cooking on two racks, stagger pans so one is not directly over the other. Use rack positions 2 and 4, or 1 and 4, depending on baking results, when cooking on two racks. Use racks 1 and 4 when using two cookie sheets.

**Never place two cookie sheets on one rack and never place aluminum foil or pans directly on the oven bottom.**

### USE OF ALUMINUM FOIL

Use aluminum foil **ONLY** as instructed in this book. Improper use of aluminum foil may cause damage to the oven, affect cooking results, and can also result in shock and/or fire hazards. Foil can be used if these guidelines are followed:

- **Do not use aluminum foil directly under the cookware.** Foil will reflect heat away from the utensil causing inadequate browning. Placing a pie directly on foil may result in a soggy bottom crust and inadequate browning.

- **Do not place aluminum foil directly on the oven bottom as this may damage the oven bottom.** A piece of foil that is slightly larger than the cooking utensil can be placed on the rack directly below the rack containing the utensil.

- **Do not completely cover an oven rack with foil.** This blocks air flow in the oven, constitutes a safety hazard, and will adversely affect cooking results.

- **Never cover the broiler insert with aluminum foil as this prevents fat from draining to the pan below.** The broiler pan can be lined with foil.

### BAKEWARE ACCESSORIES

This appliance has been tested for safe performance using conventional cookware. Do not use any devices or accessories that are not specifically recommended in this manual. Do not use stove top grills, or add-on oven convection systems. The use of devices or accessories that are not expressly recommended in this manual can create serious safety hazards, and reduce the life of the components of the appliance.

## Baking Tips

Use a **reliable recipe** and accurately measure fresh ingredients. **Carefully follow directions** for oven temperature and cooking time. Preheat oven if recommended.

**Use the correct rack position.** Baking results may be affected if the wrong rack is used.

- \* Top browning may be darker if food is located toward the top of the oven.
- \* Bottom browning may be darker if food is located toward the bottom of the oven.
- \* When using two racks for baking, allow enough space between the racks for proper air circulation. Browning and cooking results will be affected if air flow is blocked.

**Cookware material** plays an important part in baking results. Always use the type and size of pan called for in the recipe. Cooking times or cooking results may be affected if the wrong size is used.

- \* **Shiny metal pan** reflects heat away from the food, produces lighter browning and a softer crust. Use shiny pans for baking cakes or cookies.
- \* **Dark metal pan or a pan with an anodized (dull) bottom** absorbs heat, produces darker browning and a crisper crust. Use this type of pan for pies, pie crusts or bread.

- \* For optimum baking results, bake cookies and biscuits on a **flat** cookie sheet. If the pan has sides, such as a jelly roll pan, browning may not be even.
- \* If using **heatproof glassware**, or **dark pans such as Baker's Secret** reduce the oven temperature by 25°F except when baking pies or bread. Use the same baking time as called for in the recipe.

**Allow hot air to flow freely through the oven** for optimum baking results. Improper placement of pans in the oven will block air flow and may result in uneven browning. For optimum browning and even cooking results:

- \* Do not crowd a rack with pans. Never place more than one cookie sheet, one 13x9x2-inch cake pan or two 9-inch round cake pans on one rack.
- \* Stagger pans when baking on two racks so one pan is not directly over another pan.
- \* Allow two inches between the pans or between the pan and the oven walls or door.

**Check the cooking progress at the minimum time** recommended in the recipe. If necessary, continue checking at intervals until the food is done. If the oven door is opened too frequently, heat will escape the oven; this can affect baking results and wastes energy.

**If you add additional ingredients**, use different pans, or alter the recipe, expect cooking times to increase or decrease slightly.

## Roasting Tips

Roasting is the method for cooking large, tender cuts of meat uncovered, without adding moisture. Most meats are roasted at 325°F. It is not necessary to preheat the oven. Place the roasting pan on either of the two lowest rack positions.

Use tender cuts of meat weighing three pounds or more. Some good choices are: Beef rib, ribeye, top round, high quality tip and rump roast, pork loin roast, leg of lamb, veal shoulder roast and cured or smoked hams.

Season meat, if desired, either before or after roasting. Rub into the surface of the roast if added before cooking.

Place the meat fat-side-up on a rack in a shallow roasting pan. Placing the meat on a rack holds it out of the drippings, thus allowing better heat circulation for even cooking. As the

fat on top of the roast melts, the meat is basted naturally, eliminating the need for additional basting.

The cooking time is determined by the weight of the meat and the desired doneness. For more accurate results, use a meat thermometer. Insert it so the tip is in the center of the thickest part of the meat. It should not touch fat or bone.

Remove the roast from the oven when the thermometer registers approximately 5°F below the desired degree of doneness. As the meat stands, the temperature will rise.

**NOTE: For more information on cooking meat and poultry, contact the USDA Meat & Poultry Hotline at 1-800-535-4555.**

## Common Baking Problems And Why They Happen

PROBLEM	CAUSE	PROBLEM	CAUSE
<i>Cakes are uneven.</i>	Pans touching each other or oven walls. Batter uneven in pans. Oven temperature too low or baking time too short. Oven not level. Undermixing. Too much liquid.	<i>Cakes don't brown on top.</i>	Incorrect rack position. Temperature too low. Overmixing. Too much liquid. Pan size too large or too little batter in pan. Oven door opened too often.
<i>Cake high in middle.</i>	Temperature too high. Baking time too long. Overmixing. Too much flour. Pans touching each other or oven walls. Incorrect rack position.	<i>Excessive shrinkage.</i>	Too little leavening. Overmixing. Pan too large. Temperature too high. Baking time too long. Pans too close to each other or oven walls.
<i>Cake falls.</i>	Too much shortening or sugar. Too much or too little liquid. Temperature too low. Old or too little baking powder. Pan too small. Oven door opened frequently. Added incorrect type of oil to cake mix. Added additional ingredients to cake mix or recipe.	<i>Uneven texture.</i>	Too much liquid. Undermixing. Temperature too low. Baking time too short.
<i>Cakes, cookies, biscuits don't brown evenly.</i>	Incorrect rack position. Oven door not closed properly. Door gasket not sealing properly. Incorrect use of aluminum foil. Oven not preheated. Pans darkened, dented or warped.	<i>Cakes have tunnels.</i>	Not enough shortening. Too much baking powder. Overmixing or at too high a speed. Temperature too high.
<p>For optimum results, bake on one rack. If baking cakes on two racks, stagger pans so one is not directly over another.</p>		<i>Cakes crack on top.</i>	Batter overmixed. Temperature too high. Too much leavening. Incorrect rack position.
		<i>Cake not done in middle.</i>	Temperature too high. Pan too small. Baking time too short.
		<p>If additional ingredients were added to mix or recipe, expect cooking time to increase.</p>	
<i>Cakes, cookies, biscuits too brown on bottom.</i>	Oven not preheated. Pans touching each other or oven walls. Incorrect rack position. Incorrect use of aluminum foil. Placed 2 cookie sheets on one rack. Used glass, darkened, stained, warped or dull finish metal pans. (Use a shiny cookie sheet.)	<i>Pie crust edges too brown.</i>	Temperature too high. Pans touching each other or oven walls. Edges of crust too thin. Incorrect rack position.
<p>Follow cookware manufacturer's instructions for oven temperature. Glassware and dark cookware such as Ecco's Baker's Secret require lowering the oven temperature by 25° F.</p>		<i>Pies or cakes don't brown on bottom.</i>	Used shiny metal pans. Temperature too low.
		<i>Pies have soaked crust.</i>	Temperature too low at start of baking. Filling too juicy. Used shiny metal pans.



## HOW TO BROIL

**NOTE:** Broiling is done in the lower broiler oven.

Broiling is a method of cooking used for tender steaks, chops, hamburgers, chicken, fish, and some fruits and vegetables. For optimum results, steaks should be at least 3/4-inch thick.

### Broiling Tips

Trim excess fat to reduce spattering and smoking. Cut slashes in the outer edges of the meat to prevent curling during cooking.

If you plan to season the meat, it is better to do so after the surface has browned. Salt tends to delay browning which can result in overcooking. Salting before cooking also draws the juices out of the meat, causing dryness.

The cooking time is determined by the distance between the meat and the burner, the desired degree of doneness, and the thickness of the meat.

Thin cuts should be placed closer to the burner. Thicker cuts should be placed further away from the burner.

For a brown exterior and rare interior, the meat should be close to the burner. Place the pan further down if you wish the meat well done or if spattering and smoking occurs.

### Broiler Pan and Insert

Broiling requires the use of the broiler pan and insert supplied with your appliance. It is designed to drain excess liquid and fat away from the cooking surface to prevent spatters, smoke and flare ups.

Never leave a soiled broiler pan and insert in the oven after broiling. Drippings might become hot enough to ignite if exposed directly to the oven burner.

For easier clean-up, line the broiler pan (bottom piece) with aluminum foil and spray the insert with a non-stick vegetable coating. Do not cover the broiler pan insert with aluminum foil as this prevents fat from draining into the pan below.

The broiler oven can be preheated for a few minutes. However, **do not preheat the broiler pan and insert.**

### To Broil:

1. Turn the oven Thermostat knob to BROIL.

It is possible to broil longer cooking foods such as chicken or pork chops at a lower temperature to prevent overbrowning. Turn the knob to 450°F, rather than BROIL, for low temperature broiling.

2. Preheat for 2 to 3 minutes if desired.

**NOTE:** Cooking times in the Broil Chart are based on a 2 to 3 minute preheat.

3. Place the broiler pan on the recommended rack position shown in the broiling chart. If the food is placed too close to the burner, overbrowning and smoking may occur. Broiling is always done with the door closed.
4. Follow the suggested times in the broiling chart. Meat should be turned once about halfway through when the top of the meat begins to brown.
5. Check the doneness by cutting a slit in the meat near the center to check the color.

## BROILING CHART

Until you become more familiar with your new oven, use the following chart as a guide when broiling foods.

FOOD	DONENESS	6-INCH BROILER		12-INCH BROILER	
		BROIL POSITION	TOTAL BROIL TIME	BROIL POSITION	TOTAL BROIL TIME
BACON	Well Done	Middle	Broil at 450°F 6-9 minutes	Middle	8 - 12 minutes
BEEF PATTIES, 3/4-inch thick	Well Done	Middle	14-18 minutes	Upper	15 - 18 minutes
STEAKS, 1-inch thick	Rare Medium Well Done	Middle Middle Middle	12-14 minutes 15-18 minutes 18-21 minutes	Upper Upper Upper	10 - 12 minutes 12 - 14 minutes 13 - 16 minutes
CHICKEN, Pieces	Well Done	Bottom	30-35 minutes	Bottom	25 - 30 minutes
FISH, Fillet, 1/2-inch thick Steak, 1-inch thick	Flaky Flaky	Middle Middle	Broil at 450°F 10-14 minutes 13-16 minutes	Upper Upper	7 - 10 minutes 12 - 14 minutes
HAM SLICE, 1/2-inch thick (precooked)	Warm	Middle	8-10 minutes	Upper	8 - 10 minutes
PORK CHOPS, 1-inch thick	Well Done	Middle	24-28 minutes	Middle	22 - 26 minutes

\* The bottom broil position for the 6-inch broiler is the broiler bottom. The bottom position for the 12-inch broiler is the bottom rack position.

## OVEN OR BROILER DOOR

Do not place excessive weight on an open oven door or stand on an open oven door as, in some cases, it could damage the door, cause the appliance to tip over and possibly cause injury.

When opening oven door, allow steam and hot air to escape before reaching in oven to check, add or remove food.

Do not attempt to open or close door until door is completely seated on hinge arms. Never turn on oven unless door is properly in place. When baking, be sure door is completely closed. Baking results will be affected if door is not securely closed.

**To remove door:** Open door to the "stop" position (opened about 4 to 6 inches) and grasp door with both hands at each side. Do not use door handle to lift door. Lift up evenly until door clears the hinge arms.

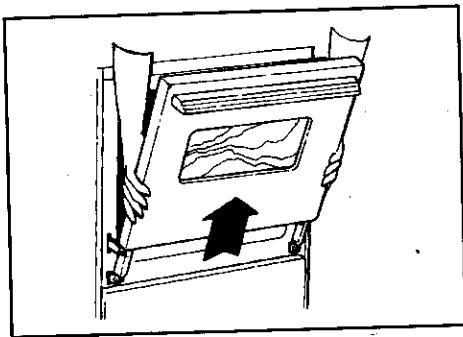

**CAUTION:** Hinge arms are spring mounted and will slam shut against the range if accidentally hit. **Never place hand or fingers between the hinges and the front oven frame.** You could be injured if hinge snaps back.

**To replace door:** Grasp door at each side, align slots in the door with the hinge arms and slide door down onto the hinge arms until completely seated on hinges.

## OVEN BOTTOM

Protect oven bottom against excessive spillovers especially acid or sugary spillovers as they may discolor the porcelain. Use the correct size cooking utensil to avoid boilovers. Never place cookware or aluminum foil directly on the oven bottom.

**To remove:** When cool, remove the oven racks. Push the oven bottom to the rear of the oven and lift up at front until the front edge of the oven bottom clears the oven front frame. Remove oven bottom from oven.

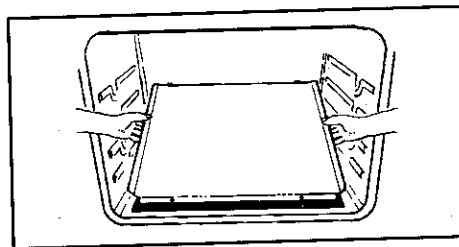

**To replace:** Fit the rear edge of oven bottom into the pin located at the center of the channel on the rear oven wall. Push toward rear of oven and lower oven bottom into place.

## BROILER BOTTOM

**To remove:** When cool, remove broiler pan and oven rack. Lift up front edge of broiler bottom. Then lift rear end up and remove broiler bottom from oven.

**To replace 12-inch broiler bottom:** Place two slots along rear flange over two screws in rear wall. Then, lower front edge into place.

**To replace 6-inch broiler bottom:** Push bottom to rear and lower into place.

## OVEN LIGHT

The oven light switch is located on the control panel. Push in rocker switch to turn oven light on and off.

Before replacing oven light bulb, **DISCONNECT POWER TO OVEN.** Be sure bulb and oven parts are cool. Do not touch a hot bulb with a damp cloth as the bulb may break.

**To replace oven light:** Use a dry pot holder, to prevent possible harm to hands; **very carefully** remove bulb. Replace with a 40 watt **APPLIANCE** bulb. Reconnect power to the oven.

## ELECTRICAL CONNECTION

Appliances which require electrical power are equipped with a three-prong grounding plug which must be plugged directly into a properly grounded three-hole 120 volt electrical outlet.

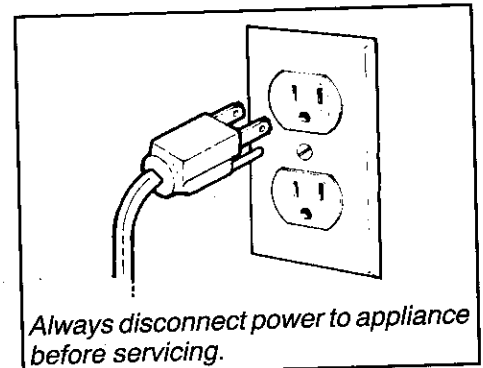

*Always disconnect power to appliance before servicing.*

The three-prong grounding plug offers protection against shock hazards. **Do not cut or remove the third grounding prong from the power cord plug.**

If an ungrounded, two-hole or other type electrical outlet is encountered, **it is the personal responsibility of the appliance owner to have the outlet replaced with a properly grounded three-hole electrical outlet.**

The following are examples of recommended cleaning agents. Brand names for cleaning agents are trademarks of the respective manufacturers. **ALWAYS READ AND FOLLOW LABEL or PACKAGE DIRECTIONS WHEN USING ANY CLEANING AGENT.**

1. Glass cleaners – Windex, Glass Plus, Cinch.
2. Mild liquid cleaners – Fantastik or Formula 409.
3. Mildly abrasive cleaners – Bon Ami, paste of baking soda and water.  
(If the powdered cleanser is recommended for use on plastic, glass, or porcelain finishes, it can be used on the same appliance finishes.)

4. Plastic or nylon scouring pad – Tuffy, Chore Boy Plastic Cleaning Puff.

5. Oven cleaners – Mr. Muscle, Easy-Off.

Oven cleaners are very caustic; read and follow label directions. Use **ONLY** in the porcelain oven. Do not use oven cleaner in Continuous Clean Oven or on any other appliance part. Oven cleaners will permanently damage (stain, etch or dull) any appliance finish except porcelain enamel oven walls.

**Be sure wall oven is off and all parts are cool before handling or cleaning to avoid damage. If a part is removed, be sure it has been correctly replaced after cleaning.**

### CLEANING CHART

PARTS	CLEANING AGENTS	DIRECTIONS
<b>Baked Enamel</b> • Oven and broiler doors	<ul style="list-style-type: none"> <li>• Soap and water</li> <li>• Paste of baking soda and water</li> <li>• Mild liquid cleaner</li> <li>• Glass cleaner</li> </ul>	<p>Use a dry towel or cloth to wipe up spills, especially acid (milk, lemon juice, fruit, mustard, tomato sauce) or sugary spills. Surface may discolor or dull if soil is not immediately removed. This is especially important for white surfaces.</p> <p>When surface is cool, wash with warm soapy water, rinse and dry. For stubborn soil, use mildly abrasive cleaning agents such as baking soda paste or Bon Ami. If desired, a thin coat of mild appliance wax can be used to protect the side panels. A glass cleaner can be used to add "shine" to the surface.</p> <p><b>NOTE:</b> Do not use abrasive, caustic or harsh cleaning agents such as steel wool pads or oven cleaners. These products will scratch or permanently damage the surface.  <b>NOTE:</b> Never wipe a warm or hot surface with a damp cloth as this may damage the surface and may cause a steam burn.</p>
<b>Broiler pan and insert</b>	<ul style="list-style-type: none"> <li>• Soap and water</li> <li>• Plastic scouring pad</li> <li>• Soap-filled scouring pad</li> <li>• Dishwasher</li> </ul>	<p>Remove from oven after use. Cool then pour off grease. Place soapy cloth over insert and pan; let soak to loosen soil. Wash in warm soapy water. Use soap-filled scouring pad to remove stubborn soil. Clean in dishwasher if desired.</p> <p><b>NOTE:</b> For easier cleanup, spray insert with a non-stick vegetable coating and line broiler pan with aluminum foil.  <b>NOTE:</b> Always store clean broiler pan and insert in the broiler compartment. If pan and insert are not cleaned after each use, the soil might become hot enough to ignite the next time the oven is used.</p>
<b>Control knob</b>	<ul style="list-style-type: none"> <li>• Soap and water</li> </ul>	<p>To remove knob for cleaning, gently pull forward. Wash in mild detergent and water. Do not soak knobs in water. Do not use abrasive cleaning agents. They will scratch finish and remove markings. Rinse dry and replace.</p>
<b>Glass</b> • Oven window	<ul style="list-style-type: none"> <li>• Soap and water</li> <li>• Paste of baking soda and water</li> <li>• Glass cleaner</li> </ul>	<p>Wash with soap and water. Use a window cleaner and a soft cloth after cleaning. Remove stubborn soil with paste of baking soda and water. Rinse with a cloth wrung out in clear water. Dry. Do not use abrasive materials such as scouring pads, steel wool or powdered cleaning agents.</p> <p><b>NOTE:</b> To avoid inside staining of oven door glass, do not oversaturate cloth.</p>
<b>Metal finishes</b> • Trim parts	<ul style="list-style-type: none"> <li>• Soap and water</li> <li>• Paste of baking soda and water</li> <li>• Glass cleaner</li> </ul>	<p>Wash with soap and water. Remove stubborn soil with paste of baking soda and water. Use a window cleaner and a soft cloth to remove fingermarks or smudges. <b>NOTE:</b> Do not use oven cleaners, abrasive or caustic agents. They will damage the finish.</p>

(continued next page)

## CLEANING CHART (continued)

PARTS	CLEANING AGENTS	DIRECTIONS
<b>Oven bottom</b> • Porcelain enamel	<ul style="list-style-type: none"> <li>• Soap and water</li> <li>• Paste of baking soda and water</li> <li>• Non-abrasive plastic pad</li> <li>• Oven cleaner</li> </ul>	<p>NOTE: The oven bottom for the Continuous Clean Oven is porcelain. Follow instructions below.</p> <p>Porcelain oven bottom: Clean, when cool, with soap and water, non-abrasive plastic pad or oven cleaner. Rinse with clear water. To make cleaning easier, protect the oven bottom by (1) using large enough cookware to prevent boilovers; (2) place a piece of aluminum foil, that is slightly larger than the cookware, on the lower rack. NEVER place foil directly on the oven bottom.</p> <p>Protect oven bottom against acid spills (milk, cheese, tomato, lemon juice, etc.) or sugary spills (pie filling) as they may pit or discolor the oven bottom.</p> <p>For easier cleaning, oven bottom can be removed and cleaned at the sink. Do not soak or immerse oven bottom in water or place under running water.</p>
<b>Oven cavity</b> • Continuous Clean Oven, see page 11.	Cleaning action begins whenever the oven is on. The oven must be used for cleaning to take place. Higher oven temperatures and longer baking times speed the cleaning action.	Brush off heavy soil with a nylon or plastic pad. Do not use paper towels, cloths, or sponges because the oven walls are porous and particles of these materials will rub off on the walls. Rinse area with clean water only. Do not use any type of oven cleaner, cleanser or detergent on this surface.
<b>Oven cavity</b> • Porcelain oven • Oven door liner	<ul style="list-style-type: none"> <li>• Soap and water</li> <li>• Mild abrasive cleaners</li> <li>• Plastic pad</li> <li>• Oven cleaner</li> </ul>	Clean oven interior with soap and water; rinse. Use cleansing powders or a plastic scouring pad to remove stubborn soil. Wipe acid or sugar stains as soon as the oven is cool as these stains may discolor or etch the porcelain. Do not use metallic scouring pads as they will scratch the porcelain. To make cleaning easier, place 1/2 cup household ammonia in a shallow glass and leave in a cold oven overnight. The ammonia fumes will help loosen the burned on grease and food. Oven cleaners can be used on the porcelain oven but follow manufacturer's directions. If oven cleaner was used, thoroughly rinse oven cavity and capillary tube which is located at the top of the oven. Oven cleaners can not be used on the continuous cleaning oven finish.
<b>Oven racks</b>	<ul style="list-style-type: none"> <li>• Soap and water</li> <li>• Cleansing powders</li> <li>• Plastic pad</li> <li>• Soap filled scouring pad</li> </ul>	Clean with soapy water. Remove stubborn soil with cleansing powder or soap filled scouring pad. Rinse and dry.  <b>NOTE:</b> If racks become difficult to slide, a thin coat of vegetable oil on the underside of the rack will make sliding easier.
<b>Plastic finishes</b> • Door handles • Trim • Overlays • Knob	<ul style="list-style-type: none"> <li>• Soap and water</li> <li>• Non-abrasive plastic pad or sponge</li> </ul>	When surface is cool, clean with soap and water; rinse, and dry. Use a window cleaner and a soft cloth.  <b>NOTE:</b> Never use oven cleaners, abrasive or caustic liquid or powdered cleaning agents on plastic finishes. These cleaning agents will scratch or mar finish. <b>NOTE:</b> To prevent staining or discoloration, wipe up fat, grease or acid (tomato, lemon, vinegar, milk, fruit juice, marinade) immediately with a dry paper towel or cloth.
<b>Silicone rubber</b> • Door gasket	<ul style="list-style-type: none"> <li>• Soap and water</li> </ul>	Wash with soap and water, rinse and dry. Do not remove door gasket.

## HOW TO REMOVE WALL OVEN FOR CLEANING OR SERVICING

Follow these procedures to remove appliance for cleaning or servicing:

1. Shut-off gas supply to appliance.
2. Disconnect electrical supply to appliance.
3. Disconnect gas supply tubing to appliance.

4. Remove the screws that secure the wall oven to the cabinet. Remove oven from cabinet.

5. Reverse procedure to reinstall. If gas line has been disconnected, check for gas leaks after reconnection. See Installation Instructions for gas leak test method.

**NOTE:** A qualified servicer should disconnect and reconnect the gas supply.

**WARNING:** Possible risks may result from abnormal usage, including excessive loading of the oven door and of the risk of tip over, should the appliance not be reinstalled according to the installation instructions.

## CONTINUOUS CLEANING OVEN, if equipped

NOTE: The oven door liner and oven bottom are porcelain enamel. For cleaning instructions, refer to the cleaning chart on page 13.

### WHAT IS THE CONTINUOUS CLEANING OVEN?

The finish of the Continuous Cleaning Oven is identified by its dark gray color, white stipple and rough, porous texture. The rough texture prevents grease spatters from forming beads which run down the walls leaving unsightly streaks. Rather, the rough texture absorbs spatters and allows them to spread, thus exposing a larger area to the hot oven air. The catalyst, when exposed to heat, speeds the oxidation of soil.

Cleaning action automatically begins whenever the oven is turned on for baking or roasting. The oven **MUST** be on for cleaning to take place. No cleaning will occur when the oven is off. The special catalytic finish must be exposed to hot oven air before soil will begin to gradually reduce in size.

### FACTORS AFFECTING LENGTH OF CLEANING TIME

The higher the oven temperature, the faster the cleaning action. The length of cleaning time will depend on these factors: Type of soil, amount or size of soil, oven temperature and length of time oven is in use. Time may vary from a few minutes to several hours. Soil deposited at the end of a cycle may still be visible. This will usually fade with continued oven use until the soil gradually disappears or can be wiped up manually. The oven will appear presentably clean, even though some spatters may be present.

## MANUALLY CLEANING HEAVY SPILLOVERS

The special finish will clean most spatters during normal oven use unless there is a heavy buildup of soil. Heavy spillovers such as pie or casserole boillovers will not clean effectively without some manual help. The crusty or varnish-like stains that form from these spillovers clog the pores and prevent the special finish from being exposed to the hot oven air. This greatly reduces the cleaning effectiveness of the finish.

These crusty or varnish-like stains must either be removed or broken up before cleaning can effectively take place.

### TO MANUALLY CLEAN HEAVY SPILLOVERS

Brush off heavy soil with a nylon brush or plastic pad. **DO NOT USE** paper towels, cloths or sponges for the oven walls are porous and particles of these materials will rub off on the walls. Rinse area with clear water only.

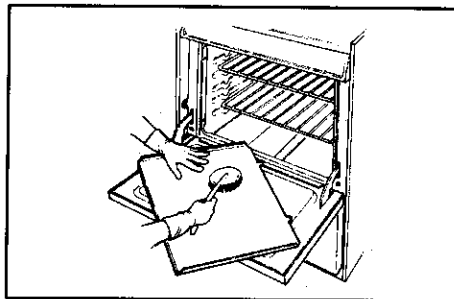

## HINTS

Brittle crusts or stains can be loosened by **GENTLY** tapping stain with a wooden or plastic utensil. Brush away any loose soil that flakes off. Varnish type stains usually need to be softened with a small amount of water or damp cloth. Remaining soil will gradually reduce with continued oven use at normal baking temperatures.

**DO NOT USE ANY TYPE OF OVEN CLEANER, POWDERED CLEANSERS, SOAP, DETERGENT OR PASTE ON ANY CONTINUOUS CLEANING SURFACE, ALSO, DO NOT USE ANY ABRASIVE MATERIALS, STEEL WOOL, SHARP INSTRUMENTS OR SCRAPERS FOR THEY WILL DAMAGE THE FINISH.**

Avoid spillovers by using utensils that are large enough to hold food. A cookie sheet or piece of aluminum foil, just a little larger than the pan, can be placed on the rack directly below the rack holding the utensil to catch spills.

Over a period of time, wear marks may appear on the embossed rack supports. This is normal and results from sliding the racks in and out of the oven. Wear marks will not affect the cleaning action of the oven.

## BEFORE CALLING A SERVICE TECHNICIAN, CHECK THE FOLLOWING:

PROBLEM	CAUSE	CORRECTION
1. Oven burner fails to light or oven does not operate	<ul style="list-style-type: none"> <li>a. power supply not connected (pilotless ignition)</li> <li>b. power failure (pilotless ignition)</li> </ul>	<ul style="list-style-type: none"> <li>a. connect power, check circuit breaker or fuse box</li> <li>b. an oven equipped with pilotless ignition will not operate during a power failure or if disconnected from power. See page 4</li> </ul>
2. Popping sound heard when burner extinguishes	This is a normal sound that occurs with some types of gas when a hot burner is turned off. The popping sound is not a safety hazard and will not damage the appliance.	
3. Clock and/or oven light does not work	<ul style="list-style-type: none"> <li>a. power supply not connected</li> <li>b. bulb may be loose or burned out</li> <li>c. malfunctioning switch</li> <li>d. malfunctioning clock or loose wiring</li> </ul>	<ul style="list-style-type: none"> <li>a. connect power supply, check circuit breaker or fuse box</li> <li>b. tighten or replace light bulb</li> <li>c. call serviceman to check</li> <li>d. call serviceman to check</li> </ul>
4. Moisture condensation on oven window, if equipped	<ul style="list-style-type: none"> <li>a. it is normal for the window to fog during the first few minutes the oven is on</li> <li>b. cloth saturated with water is used to clean the window</li> </ul>	<ul style="list-style-type: none"> <li>a. leave door ajar for one or two minutes to allow moisture to escape</li> <li>b. Use a damp cloth to clean window to prevent excess water from seeping between the panels of glass</li> </ul>
5. Oven temperature inaccurate <ul style="list-style-type: none"> <li>• food takes too long or cooks too fast</li> <li>• pale browning</li> <li>• food over-done on outside and under-done in center</li> <li>• over browning</li> </ul>	<ul style="list-style-type: none"> <li>a. oven not preheated</li> <li>b. incorrect rack position</li> <li>c. incorrect use of aluminum foil</li> <li>d. oven bottom incorrectly replaced</li> <li>e. oven thermostat sensing device out of holding clip(s)</li> </ul>	<ul style="list-style-type: none"> <li>a. preheat oven 10 to 15 minutes</li> <li>b. see page 5</li> <li>c. see page 5</li> <li>d. replace oven bottom correctly</li> <li>e. reinstall sensing device securely into clip(s)</li> </ul> See Problem Chart on page 7 See baking tips on page 6
6. Poor baking results		See pages 4 to 7 for information on baking
7. Oven smokes excessively during a broil operation	<ul style="list-style-type: none"> <li>a. food too close to burner</li> <li>b. meat has too much fat</li> <li>c. sauce applied too early or marinade not completely drained</li> <li>d. soiled broiler pan</li> <li>e. broiler insert covered with aluminum foil</li> </ul>	<ul style="list-style-type: none"> <li>a. move broiler pan down one rack position</li> <li>b. trim fat</li> <li>c. apply sauce during last few minutes of cooking. If meat has been marinated, drain thoroughly before cooking</li> <li>d. always clean broiler pan and insert after each use</li> <li>e. never cover insert with foil as this prevents fat from draining to pan below</li> </ul>
8. Poor broiling results	<ul style="list-style-type: none"> <li>a. oven set incorrectly</li> <li>b. incorrect rack position</li> </ul>	<ul style="list-style-type: none"> <li>a. turn knob to broil</li> <li>b. raise or lower rack one position</li> </ul>

## HOW TO OBTAIN SERVICE

When your appliance requires service or replacement parts, contact your Dealer or Authorized Servicer. Use only genuine factory. Consult the Yellow Pages in your telephone directory under appliance for the service center nearest you.

If you are unable to obtain service, write to us. Our address is found on the rating plate. See inside front cover for location of rating plate. Be sure to include your name, address, and phone number,

along with the model and serial numbers of the appliance.

If you are not satisfied with the local response call or write Maytag Customer Service, 240 Edwards Street, S.E., Cleveland, TN 37311, (615) 472-3500.

If you did not receive satisfactory service through your servicer or Maytag Customer Service you may contact the Major Appliance Consumer Action Panel. Include your name, address,

and telephone number, as well as the model and serial numbers of the appliance. Write to: Major Appliance Consumer Action Panel, 20 North Wacker Drive, Chicago, Illinois 60606.

MACAP (Major Appliance Consumer Action Program) is an independent agency sponsored by three trade associations as a court of appeals on consumer complaints which have not been resolved satisfactorily within a reasonable period of time.