

Use & Care Manual

Electric Range

CONTENTS

	Page
Product Registration	2
Important Safety Instructions	3-4
Installation Instructions	5-6
Oven Light	6
Surface Light	7
Circuit Protection	7
Indicator Light	7
Models with Touch Pad Control	7
Specialty Pans & Trivets	8
Canning Tips & Information	8
Selecting Surface Cooking Utensils	9
Surface Cooking	
Setting Surface Controls (some models)	9
Ceramic Glass Cooktop (some models)	10-15
Types of heating units used	10
Models with Electronic Surface	
Element Controls (ESEC)	11-14
Setting Warm Zone Controls	15
Oven Baking	16
Air Circulation	16
Convection Cooking (some models)	17
Convection Roasting (some models)	17
Speed Bake Cooking System (some models)	18
Broiling	19
Oven Settings	19
General Cleaning	
Cleaning Various Parts of Your Range	20
Ceramic Glass Cooktop (some models)	21-22
Care and Cleaning of Stainless Steel (some models) ..	22
Cleaning the appliance	23-26
To Remove and Replace the Oven Door	26
Removable Outer Door Glass Panel (some models)	27
To Remove and Replace Storage Drawer	27
Warmer Drawer (some models)	28-29
Avoid Service Checklist	30-31
Warranty	32

Visit the Frigidaire Web Site at:
<http://www.frigidaire.com>

Product Registration

Register Your Product

The self-addressed **PRODUCT REGISTRATION CARD** should be filled in completely, signed and returned to Electrolux Home Products North America.

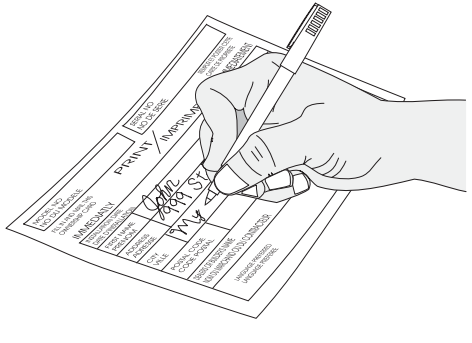

Thank you for choosing this appliance. The information contained within this **Owner's Guide** will instruct you on how to properly operate and care for your range. Please read through the information contained in your literature pack to learn more about your new appliance.

Record Your Model and Serial Numbers

Record in the space provided below the model and serial numbers. The numbers are found on the serial plate located at the right of the range frame and are visible when the drawer is open.

Model Number: _____

Serial Number: _____

Date of Purchase: _____

This Owner's Guide contains general operating instructions for your range and feature information for several models. Your range **may not** have all the described features. The graphics shown are representational. The graphics on your range may not look exactly like those shown.

Note: The instructions appearing in this Owner's Guide are not meant to cover every possible condition and situation that may occur. Common sense and caution must be practiced when installing, operating and maintaining any appliance.

Important: Keep a copy of your bill of sale.

The date on the bill establishes the warranty period service be required. Place it where it can be easily retrieved. If service is performed while the appliance is under warranty, you may have to show your bill of sale.

IMPORTANT SAFETY INSTRUCTIONS

Read all instructions before using this appliance.
Save these instructions for future reference.

This guide contains important safety symbols and instructions. Please pay special attention to these symbols and follow all instructions given. Here is a brief explanation of these symbols.

⚠ WARNING This symbol will help you to situations that may cause serious bodily harm, death or property damage.

⚠ CAUTION This symbol will help you to situations that may cause bodily injury or property damage.

- **Remove all tape and packaging wrap before using the range. Destroy the carton and plastic bags after unpacking the range.** Never allow children to play with packaging material.

- **Proper Installation—Be sure your appliance is properly installed and grounded by a qualified technician in accordance with CSA C22.1 PART 1 — latest edition and local code requirements.** Install only per installation instructions provided in the literature package for this range.

Ask your dealer to recommend a qualified technician and an authorized repair service. Know how to disconnect the electrical power to the range at the circuit breaker or fuse box in case of an emergency.

- **User Servicing — Do not repair or replace any part of the appliance unless specifically recommended in the manuals.** All other servicing should be done only by a qualified technician to reduce the risk of personal injury and damage to the range.

- **Never modify or alter the construction of a range by removing panels, wire covers or any other part of the product.**

⚠ WARNING Stepping, leaning or sitting on the door or drawer of this range can result in serious injuries and may also cause damage to the range. Do not allow children to climb or play around the range. The weight of a child on an open door may cause the range to tip, resulting in serious burns or other injury.

⚠ WARNING Do not use the oven for storage.

- **Storage in or on Appliance — Flammable materials should not be stored in an oven, near surface units or in the storage drawer.** This includes paper, plastic and cloth items, such as cookbooks, plasticware and towels, as well as flammable liquids. Do not store explosives, such as aerosol cans, on or near the range. Flammable materials may explode and result in fire or property damage.

⚠ CAUTION Do not store items of interest to children in the cabinets above a range or on the backguard of a range. Children climbing on the range to reach items could be seriously injured.

- **Do not leave children alone. Children should not be left alone or unattended in the area where an appliance is in use.** They should never be allowed to sit or stand on any part of the appliance.

- **DO NOT TOUCH SURFACE UNITS, AREAS NEAR THESE UNITS, OVEN HEATING ELEMENTS OR INTERIOR SURFACES OF THE OVEN.** Both surface units and oven heating elements may be hot even though they are dark in color. Areas near surface units may become hot enough to cause burns. During and after use, do not touch, or let clothing or other flammable materials touch these areas until they have had sufficient time to cool. Among these areas are the cooktop, surfaces facing the cooktop, the oven vent openings and surfaces near these openings, oven door and window.

- **Wear Proper Apparel — Loose-fitting or hanging garments should never be worn while using the appliance.** Do not let clothing or other flammable materials contact hot surfaces.

⚠ WARNING Never use your appliance for warming or heating the room.

- **Do Not Use Water or Flour on Grease Fires—Smother the fire with a pan lid, or use baking soda, a dry chemical or foam-type extinguisher.**

- **When heating fat or grease, watch it closely.** Fat or grease may catch fire if allowed to become too hot.

- **Use Only Dry Potholders — Moist or damp potholders on hot surfaces may result in burns from steam.** Do not let the potholders touch hot heating surface units or interior oven elements. Do not use a towel or other bulky cloth instead of a potholder.

- **Do Not Heat Unopened Food Containers—Build-up of pressure may cause the container to burst and result in injury.**

- **Remove the oven door from any unused range if it is to be stored or discarded.**

- **IMPORTANT—Do not attempt to operate the oven during a power failure. If the power fails, always turn the oven off.** If the oven is not turned off and the power resumes, the oven will begin to operate again. Food left unattended could catch fire or spoil.

⚠ CAUTION Electronic controllers can be damaged by cold temperatures. When you use your range for the first time, or if it has not been used for a long period of time, make sure that it has been exposed to a temperature above 0°C/32°F for at least 3 hours before connecting it to the power supply.

IMPORTANT SAFETY INSTRUCTIONS (continued)

IMPORTANT INSTRUCTIONS FOR USING YOUR COOKTOP

- **Know which knob controls each surface heating unit.**
- **Use Proper Pan Size** — This appliance is equipped with one or more surface units of different sizes. Select utensils having flat bottoms large enough to cover the surface unit. The use of undersized utensils will expose a portion of the surface heating unit to direct contact and may result in ignition of clothing. Proper relationship of utensil to the surface unit will also improve efficiency.
- **Utensil Handles Should Be Turned Inward and Should Not Extend Over Adjacent Surface Units** — To reduce the risk of burns, ignition of flammable materials, and spillage due to unintentional contact with the utensil.
- **Never Leave Surface Units Unattended** — Boilovers cause smoking and greasy spillovers that may ignite, or a pan that has boiled dry may melt.
- **Protective Liners** — Do not use aluminum foil to line oven bottom or any other part of the range. Only use aluminum foil as recommended for baking if used as a cover placed on the food. Any other use of protective liners or aluminum foil may result in a risk of electric shock or fire or a short circuit.
- **Glazed Cooking Utensils** — Only certain types of glass, glass/ceramic, ceramic, earthenware, or other glazed utensils are suitable for rangetop service without breaking due to the sudden change in temperature. Check the manufacturer's recommendations for rangetop use.

FOR GLASS COOKTOPS ONLY

- **Do Not Cook on Broken Cooktop** — If cooktop should break, cleaning solutions and spillovers may penetrate the broken cooktop and create a risk of electric shock. Contact a qualified technician immediately.
- **Clean Cooktop with Caution** — If a wet sponge or cloth is used to wipe spills on a hot cooking area, be careful to avoid a steam burn. Some cleaners can produce harmful fumes if applied to a hot surface.

IMPORTANT INSTRUCTIONS FOR USING YOUR OVEN

- **Use Care When Opening Door** — Stand to the side of the range when opening the door of a hot oven. Let hot air or steam escape before you remove or replace food in the oven.

- **Keep Oven Vent Ducts Unobstructed.** The oven is vented between the cooktop and the backguard. Touching the surfaces in this area when the oven is operating may cause severe burns. Also, do not place plastic or heat-sensitive items on or near the oven vent. These items could melt or ignite.
- **Placement of Oven Racks.** Always place oven racks in desired location while oven is cool. Remove all utensils from the rack before removing rack. If rack must be moved while oven is hot, use extreme caution. Use potholders and grasp the rack with both hands to reposition. Do not let potholders contact the hot oven element or interior of the oven.
- **Do not use a broiler pan without its insert.** The broiler pan and grid allow dripping fat to drain and be kept away from the high heat of the broiler.
- **Do not cover the broiler grid with aluminum foil.** Exposed fat and grease could ignite.
- **Do not touch a hot light bulb with a damp cloth.** Doing so could cause the bulb to break. Disconnect the range or turn off the power to the range before removing and replacing light bulb.

IMPORTANT INSTRUCTIONS FOR CLEANING YOUR RANGE

- **Clean the range regularly to keep all parts free of grease that could catch fire.** Exhaust fan ventilation hoods and grease filters should be kept clean. Do not allow grease to accumulate. Greasy deposits in the fan could catch fire. Refer to the hood manufacturer's instructions for cleaning.
- **Cleaners/Aerosols** — Always follow the manufacturer's recommended directions for use. Be aware that excess residue from cleaners and aerosols may ignite causing damage and/or injury.

SELF-CLEANING OVENS:

- **Clean in the self-cleaning cycle only the parts of the oven listed in this owner's guide.** Before self-cleaning the oven, remove all utensils stored in the oven.
- **Do not clean the oven door gasket.** Care should be taken not to rub, damage or move the gasket.
- **Do not use oven cleaners.** No oven cleaner or oven liner protective coating of any kind should be used in or around any part of the oven.
- **Remove oven racks.** Oven racks colour will change if left in the oven during a self-cleaning cycle.

⚠ CAUTION The health of some birds is extremely sensitive to the fumes given off during the self-clean cycle of any range. Move birds to another well ventilated room.

SAVE THESE INSTRUCTIONS

Installation Instructions

Installation and service must be performed by a qualified technician.

IMPORTANT: Save for the local electrical inspector's use.

Read and save these instructions for future reference.

Clearances and Dimensions

- Provide adequate clearances between the range and adjacent combustible surface (1.3cm (1/2")) to the cabinet side walls and the rear wall).
- Location—Check location where the range will be installed. Check for proper electrical supply and the stability of floor.
- Dimensions that are shown must be used. Given dimensions provide minimum clearance. Contact surface must be solid and level.

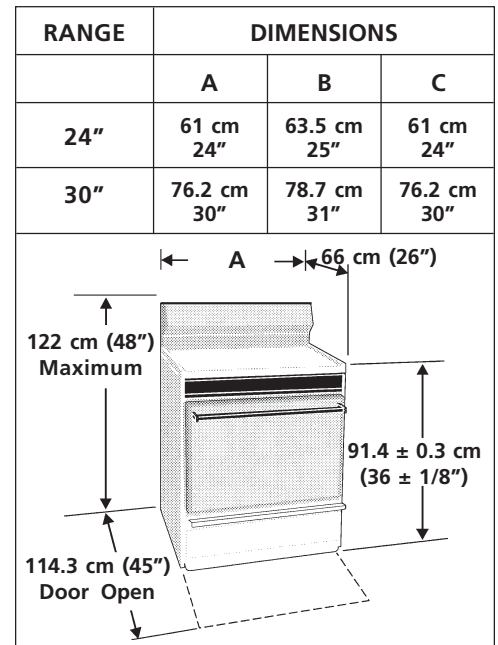
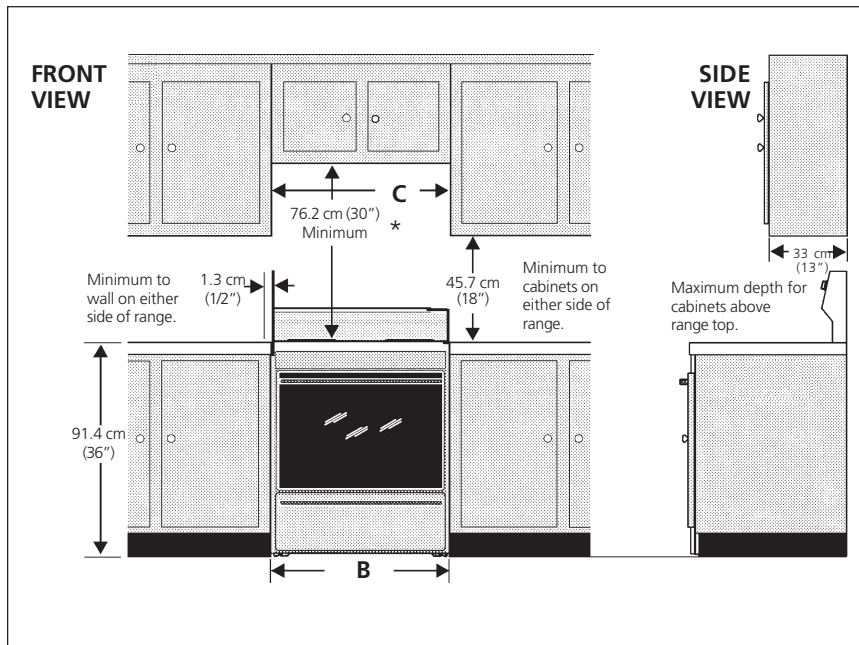

* 76.2 cm (30") Minimum clearance between the top of the cooking surface and the bottom of an unprotected wood or metal cabinet; or 61 cm (24") Minimum when bottom of wood or metal cabinet is protected by not less than 0.64 cm (1/4") flame retardant millboard covered with not less than 0.038 cm (0.015") stainless steel, 0.061 cm (0.024") aluminum or 0.051 cm (0.020") copper. 1.3 cm (1/2") clearance is the minimum for the rear and sides of the range. Follow all dimension requirements provided above to prevent property damage, Potential fire hazard, and incorrect countertop and cabinet cuts.

To eliminate the risk of burns or fire by reaching over heated surface units, cabinet storage space located above the surface units should be avoided. If cabinet storage is to be provided, the risk can be reduced by installing a range hood that projects horizontally a minimum of 12.7 cm (5") beyond the bottom of the cabinets.

Electrical Hook-Up

This appliance must be connected to a grounded 120/240 volt or 120/208 volt Range outlet. If no outlet is available, have one installed by a qualified electrician.

Location

Set your new range 1.3 cm (1/2") away from the rear wall and line it up with the kitchen counters. Make sure there is at least 1.3 cm (1/2") of clearance between each side of the range and the kitchen counters. Allow 7.6 cm (3") min. clearance between your range and the refrigerator, if they are side by side.

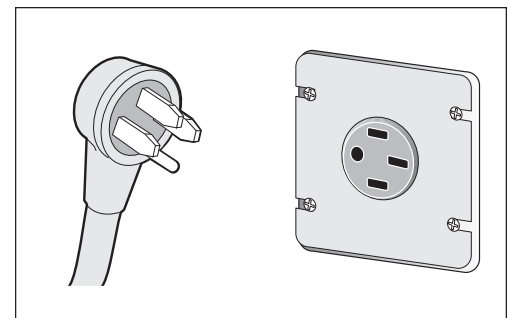

Installation Instructions (continued)

Leveling

For good baking results, your range should be level. Screw type leveling legs are provided at each corner of the range at the base. Remove the storage drawer to adjust the leveling legs. (Refer to Storage Drawer section).

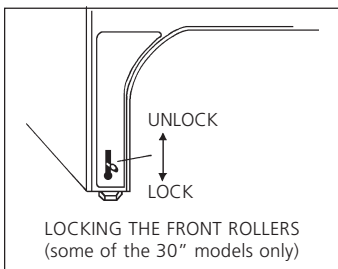
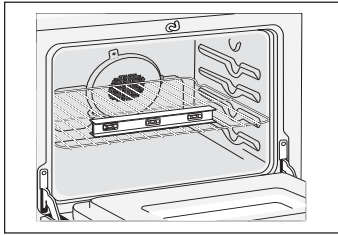
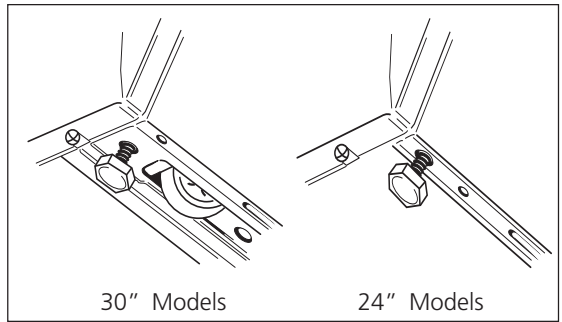

To level the range:

1. Use a 1-1/4" open end key or an adjustable wrench to equally unscrew the four leveling legs two to three turns each.
2. Install an oven rack in the center of the oven.
3. Move the range to its final position, then put a spirit level on the rack to check for levelness. Take two readings, one with the level placed diagonally first in one direction, and then the other.
4. Use the 1-1/4" key or wrench to adjust the leveling legs. Turn each one until the range stands firm without wobbling.
5. Some models are supported by smooth glide rollers to facilitate moving. If floor is flat and level, open the drawer and lower the front roller locking levers (some models) to prevent the range from moving. If floor is not flat or level or if this model has rollers without locking levers, use the 4 leveling legs to level, support and prevent the range from moving.

Oven Light

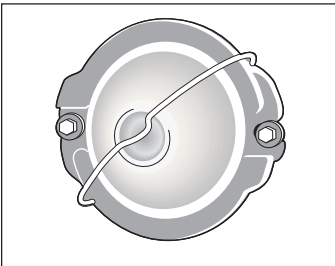

CAUTION Do not turn the oven light on during the self-cleaning cycle. High temperature will reduce lamp life.

On some models an interior oven light will turn on automatically when the oven door is opened. The oven light may be turned on when the door is closed by using the oven light switch located on or underneath the control panel.

On a self clean oven the lamp is covered with a glass shield held in place by a wire holder. **THIS GLASS SHIELD MUST BE IN PLACE WHENEVER THE OVEN IS IN USE.**

To replace the light bulb:

CAUTION BE SURE OVEN IS COOL.

1. Turn the power off at the main source.
2. Wear a leather-faced glove for protection against possible broken glass.
3. Replace bulb with a 40 watt appliance bulb only.
4. For self-cleaning oven, press wire holder to one side to release glass shield, change bulb and be sure to replace glass shield.

Surface Light (some models)

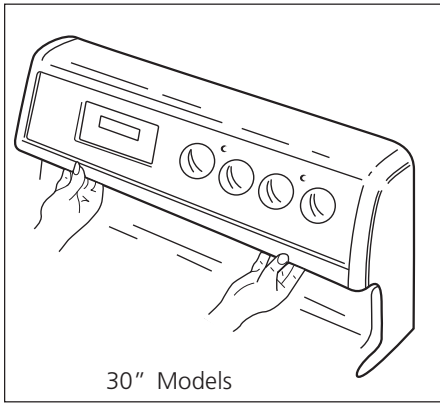

⚠ CAUTION Be sure all surface element control knobs are turned off "●" and elements are cool.

Use switch located on or underneath the control panel to turn the surface light ON/OFF. Replace the surface light, if after repeated attempts to turn it on you are not successful.

30" RANGE SURFACE LIGHT REPLACEMENT (some models)

To remove and replace the fluorescent light:

1. Place your fingers under the tube at approximately 20.3 cm (8") from each end.
2. To remove, turn the tube 90° then pull it down and out of its sockets.
3. To replace the tube, engage the new tube into the sockets, then rotate and snap the tube in place. Turn on the surface light to make sure it will lit.

24" RANGE SURFACE LIGHT REPLACEMENT (Some models)

To remove and replace the fluorescent light:

1. Lift up the control panel cover.
2. Place your fingers on the tube at approximately 20.3 cm (8") from each end.
3. To remove, turn the tube 90° then pull it out of its sockets.
4. To replace the tube, engage the new tube into the sockets, then rotate and snap the tube in place light to make it sure it will lit

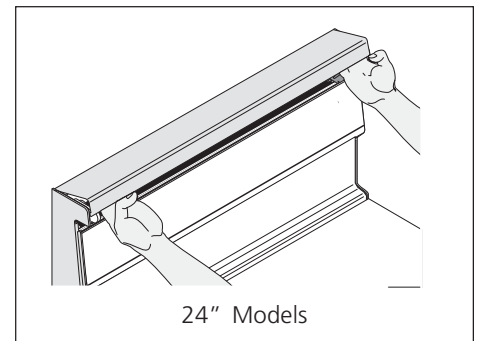

Circuit Protection

As a protection against surcharge, a 15 amp, 120 volt fuse is provided for each of the electric outlet(s) (2 max.) located on top of the control panel. To access the fuse(s) raise the control panel cover. Models with no electric outlet have no fuse.

Indicator Light

Some models have an indicator light for each heating unit, other models have an indicator light for each pair of heating units. Some models have indicator lights only with the warmer zone and warmer drawer.

The indicator light glows as soon as a heating unit is turned on. Check if the indicator light glows when the control knob of the individual heating unit is turned on. If the knob is set to a very low temperature setting, the indicator may glow and yet, the heating unit may not be heating at all. If this happens, turn the knob to a higher setting until the heating unit comes on.

When cooking is finished, a glance at the indicator lights is an easy check to be sure all the control knobs have been turned to **OFF**.

Models with Touch Pad Control (only)

NOTE: When the oven is in a baking, convection baking, broiling or self-cleaning operation, a cooling fan may automatically turn on and off to cool internal parts. It is normal and the fan may continue to run even after oven is turned off.

Specialty Pans & Trivets

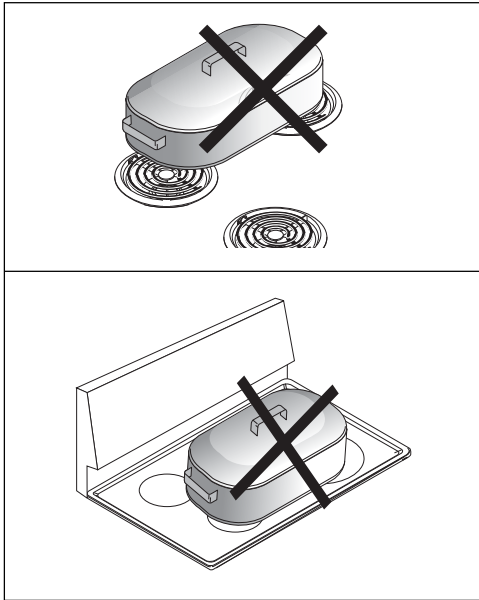

Woks with flat bottoms suitable for use on your cooktop are available in most cookshop or hardware stores. Round-bottomed woks (with a support ring that does not extend beyond the heating element) may also be used. The metal ring was designed to support the wok safely when it is filled with large amounts of liquids (soup making) or fat (frying).

⚠ CAUTION DO NOT use two elements (if the cooktop is not equipped with bridge element) to heat one large pan such as a roaster or griddle, or allow cooking utensils to boil dry. The bottom surface of the pan in either of these situations could cause discoloring or crazing of the porcelain enamel range surface, and damage to the surface elements and/or damage to the drip pans (if equipped).

Wire trivets: Do not use wire trivets. Cookware bottoms must be in direct contact with the surface elements.

DO NOT use a wok if it is equipped with a metal ring that extends beyond the surface element. Because this ring traps heat, the surface element and cooktop surface could be damaged.

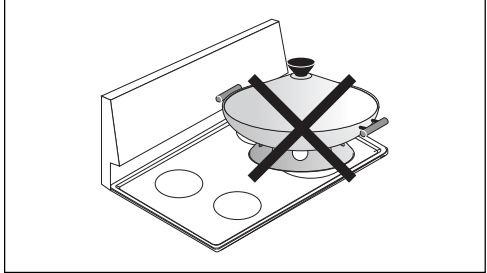

For glass smoothtop models, only flat bottomed woks (without support rings) may be used.

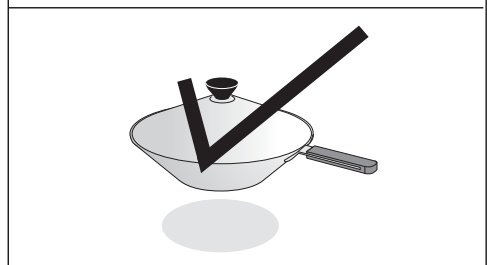

Canning Tips & Information

⚠ CAUTION Canning can generate large amounts of steam. Use extreme caution to prevent burns. Always raise the lid to vent steam away from you.



1. Use tested recipes and follow instructions carefully. Check with your local Cooperative Agricultural Extension Service or a manufacturer of glass jars for the latest canning information.
2. Use flat-bottomed canners only. Heat is spread more evenly when the bottom surface is flat.
3. Center canner on the surface element.
4. Start with hot water and a high heat setting to reduce the time it takes to bring the water to a boil; then reduce the heat setting as low as possible to maintain a constant boil.
5. It is best to can small amounts and light loads.

⚠ CAUTION Prevent damage to cooktop:

1. Do not use water bath or pressure canners that extend more than one inch beyond the edge of the surface element.
2. Do not leave water bath or pressure canners on high heat for an extended amount of time.
3. Alternate surface elements between each batch to allow the units and surrounding surfaces to cool down. Try to avoid canning on the same element all day.

⚠ CAUTION Safe canning requires that harmful micro-organisms are destroyed and the jars are sealed completely. When canning in a water bath canner, a gentle but steady boil must be maintained continuously for the required time.

Selecting Surface Cooking Utensils

For best results and energy conservation, choose cooking utensils that have these characteristics:

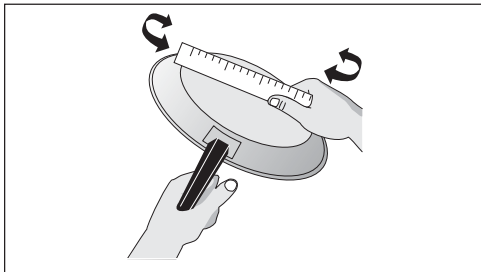

Pans should have flat bottoms that make good contact with the entire surface element. Check for flatness by rotating a ruler across the bottom. There should be no gaps between the pan and ruler.

Note: Always use a utensil for its intended purpose. Follow manufacturer's instructions. Some utensils were not made to be used in the oven or on the cooktop.

*GOOD

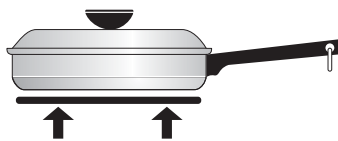

- **Flat bottom** and straight sides.
- Tight fitting lids.
- Weight of handle does not tilt pan. Pan is well balanced.
- Pan sizes match the amount of food to be prepared and the size of the surface element.
- Made of material that conducts heat well.
- Easy to clean.

* Specialty pans such as lobster pots, griddles and pressure cookers may be used but must conform to the above recommended cookware requirements.

POOR

- Curved and warped pan bottoms.



- Pan overhangs unit by more than 2.5 cm (1").



- Heavy handle tilts pan.



- Pan is smaller than element.



Surface Cooking

Setting Surface Controls (some models)

1. Place the pan on the surface element.
2. Push in and turn the surface element control knob to desired setting.
3. The surface signal light will glow when one or more elements are turned on.
Always turn the element off before removing the pan.

The suggested settings found in the chart below are based on cooking in medium-weight aluminum pans with lids. Settings may vary when using other types of pans.

Note: The size and type of utensil used, and the amount and type of food being cooked will influence the setting needed for best cooking results.

Setting	Type of Cooking
MAX	Start most foods, bring water to a boil, pan broiling.
MEDIUM	Maintain a slow boil, thicken sauces and gravies, steam vegetables.
MEDIUM LOW	Keep foods cooking, poach, stew.
MIN	Keep warm, melt, simmer.

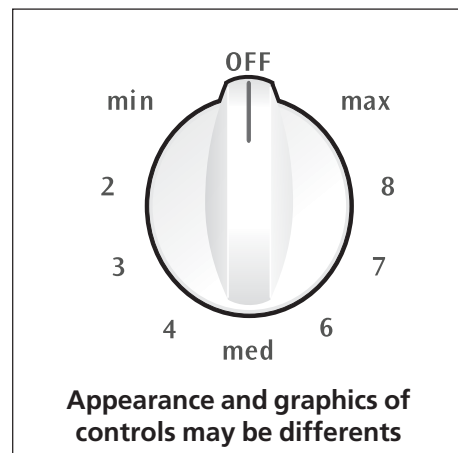

CAUTION Do not place plastic items such as salt and pepper shakers, spoon holders or plastic wrappings on top of the cooktop when it is in use.

These items could melt or ignite. Potholders, towels or wood spoons could catch fire if placed too close to the element.

WARNING DO NOT use the surface element in self-clean mode.

During the self-clean cycle, the surface elements, when used, are subjected to high heat. To ensure maximum element life, do not use the surface element during a self-clean cycle.

Surface Cooking (continued)

Ceramic Glass Cooktop (some models)

The ceramic-glass cooktop has electric heating coils located below the ceramic glass surface. The design of the glass cooktop outlines the area of the surface heating unit below. Most importantly, make sure the diameter of the pan matches the diameter of the surface unit. Heat is transferred up through the surface of the cooktop. Only flat-bottomed pans should be used. The type and size of the cookware, number of surface units in use and the settings of the surface units are factors that will affect the amount of heat that will spread to areas surrounding the units. The areas surrounding the units may become hot enough to cause burns.

The cooktop should not be used as a cutting board or work surface. Dropping heavy or hard objects on the cooktop may crack it. Pans with rough bottoms may scratch the cooktop surface. Placing foods directly on the smoothtop surface (without cooking utensils) is not recommended as difficult cleaning will result and foods may smoke and cause a potential fire hazard. Never use the griddle or similar cooking sheet on the ceramic glass cooktop.

Types of heating units used (some models)

Depending on model, three types of heating units may be found under the ceramic glass cooktop:

- **Regular** (single coil) **radiant elements** of various diameters or shapes.
- **Expandable** type (double circuits) **radiants elements** of various diameters or shapes.
- **Bridge Expandable** type (triple circuits) **radiants elements** of various diameters or shapes.

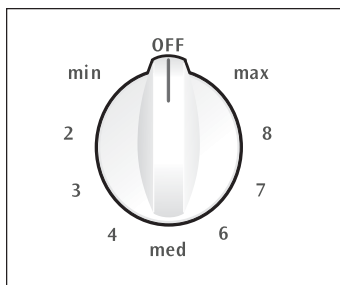

Regular radiant elements (some models)

The ceramic glass design shows the location of the heating surfaces.

Control knobs are used to set the heat power levels; knobs need first to be pressed in when at OFF position, then turned to the desired heat settings.

A glowing red surface unit extending beyond the bottom edge of the cooking utensil indicates the utensil is too small for the unit. The control knob does not have to be set exactly on a particular mark. Use the marks as a guide and adjust the control knob as needed. The hot surface and surface indicator lights will glow.

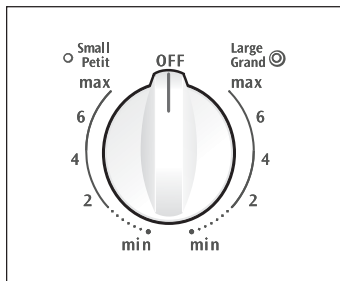

Expandable radiant elements (some models)

This heating unit combines the characteristics of a small and a large regular radiant heating unit. Its principal advantage is to allow small and large utensils to be used on the same heating unit, therefore increasing the cooktop flexibility.

Heat power levels are adjusted by a special control knob that has a dual set of graduations; for small utensils use the small graduations; the inner surface only will be heating. For larger utensils use the larger graduations; the whole surface will be heating.

The hot surface and surface indicator lights will glow when the heating unit is turned ON.

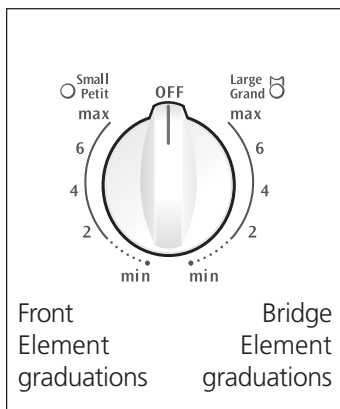

Bridge Radiant elements (some models)

Its principal advantage is to allow you to create larger cooking zone for larger pan such as roaster, griddle or some other specialty pans.

To use the bridge element, turn the control knob on left side, to the bridge element settings.

For full bridge element operation turn on the rear element.

To use only the front element, turn the control knob on right side, to the front element settings.

Note: Appearance and graphics of controls may be different

Surface Cooking (continued)

Ceramic Glass Cooktop (some models) (continued)

Models with Electronic Surface Element Controls (ESEC)

Appearance and graphics of cooktops may be different

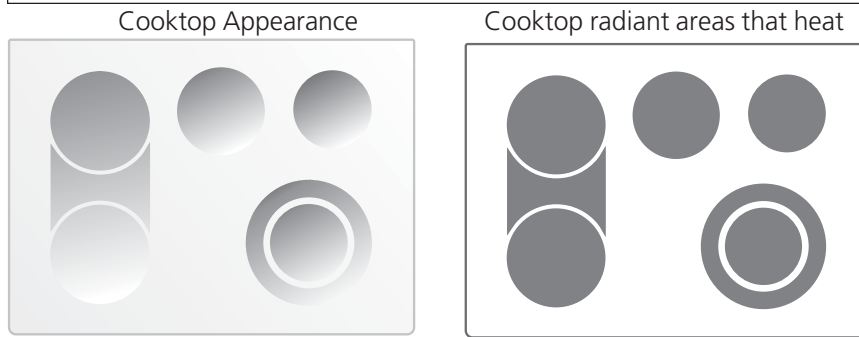

Figure 1

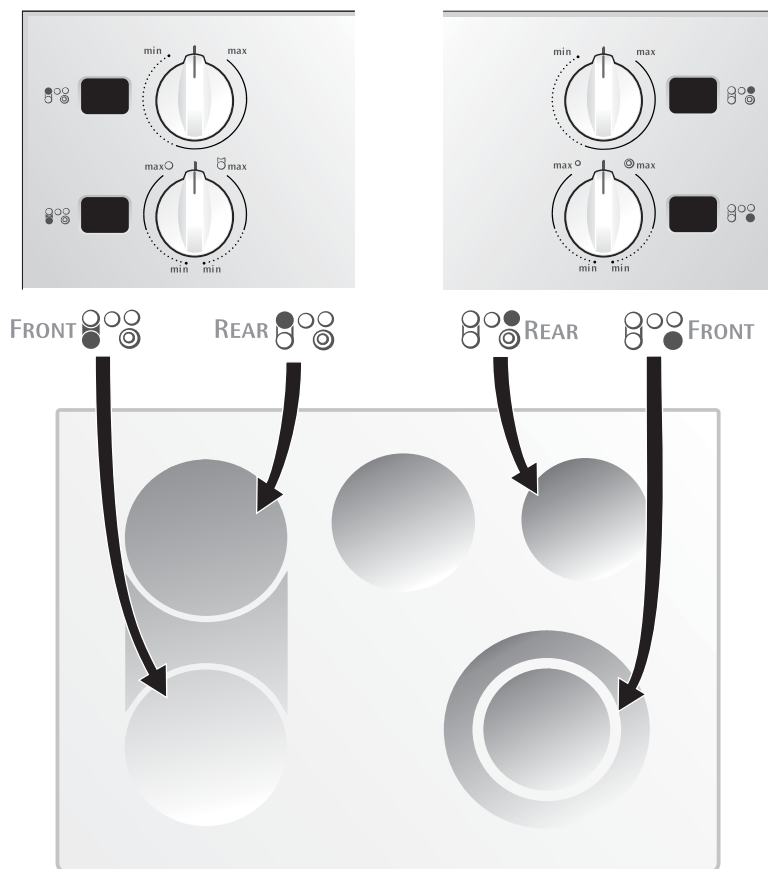

Figure 2

About the Ceramic Glass Cooktop

The ceramic cooktop has radiant surface elements located below the surface of the glass. The design of the ceramic cooktop outlines the area of the surface element underneath.

Make sure the diameter of the pan matches the diameter of the element outline on the cooktop (see figure 1).

Heat is transferred up through the surface of the cooktop to the cookware. Only flat-bottom cookware should be used. The type and size of cookware, the number of surface elements in use and their settings, are all factors that will affect the amount of heat that will spread to areas beyond the surface elements. The areas surrounding the elements may become **hot enough to cause burns**.

About the Radiant Surface Elements

The element temperature rises gradually and evenly. As the temperature rises, the element will glow red. To maintain the selected setting, the element will cycle on and off. The heating element retains enough heat to provide a uniform and consistent heat during the off cycle. For efficient cooking, turn off the element several minutes before cooking is complete. This will allow residual heat to complete the cooking process.

Locations of the Radiant Surface Elements and Controls

Your appliance is equipped with radiant surface elements with different wattage ratings. The ability to heat food quicker and in larger volumes increases as the element wattage increases.

The example shown (figure 2) describes a model with all kinds of elements you could possibly have. **We will take this example all along this section, but the appearance and graphics of your cooktop may be different.** Figure 2 has a smaller **6 inch** radiant element located at the right rear position; a **dual 6 or 9 inch** radiant element located at the right front position; a **Warmer Zone** radiant element at the center rear position; and two **8 inch** radiant elements located at both the left front and rear positions. Located between left front and rear elements is a **Bridge** radiant element.

The Bridge radiant element is controlled using the same knob that controls the left front radiant element position.

Surface Cooking (continued)

Ceramic Glass Cooktop (some models) (continued)

Models with Electronic Surface Element Controls (ESEC)

The Electronic Surface Element Control (“ESEC”) feature includes 4 digital display windows. The ESEC feature provides a numeric digital setting for 4 of the radiant surface element positions on the cooktop, including shared settings at the left front knob control position for both the left front radiant element and the “Bridge” radiant element. Also the right front control knob position shares settings for the dual radiant element. These settings work the same way as normal knob setting indicators work except the settings are displayed in digital windows (figures 1 thru 4).

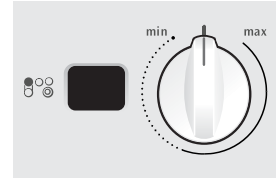

Figure 1

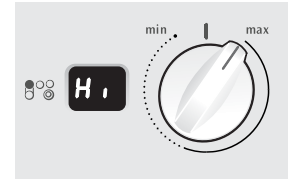

Figure 2

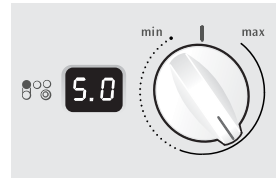

Figure 3

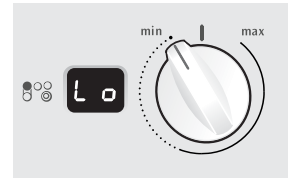

Figure 4

The available ESEC Display Settings

The ESEC control provides various heat levels from **Hi** (Fig. 2) to **Lo** (Fig. 4) and **OFF** (Fig. 1). The settings from **Hi** to **3.0** decrease in increments of .5. The settings from **3.0** to **Lo** (Simmer settings) decrease in increments of .2 for more precise settings of lower heat levels.

Use the chart (Fig. 5) to determine the correct setting for the kind of food you are preparing. The Simmer settings are used to simmer and keep larger quantities of foods warm such as stews and soups. The lower Simmer settings are ideal for delicate foods and melting chocolate or butter.

Note: The size and type of cookware used will influence the setting needed for best cooking results.

Surface Cooking Settings

Setting	Type of Cooking
MAX	Start most foods, bring water to a boil, pan broiling.
MEDIUM	Maintain a slow boil, thicken sauces and gravies, steam vegetables.
MEDIUM LOW	Keep foods cooking, poach, stew.
MIN	Keep warm, melt, simmer.

Figure 5

ESEC Error Indicator Message (Er)

An error message will be displayed (flashing “Er”) at power (or after a power failure) if ANY of the surface control knobs were left in the ON positions. If a power failure should occur, be sure to set all of the 4 surface control knobs to the OFF position (see figure 6). This will reset the surface controls.

Be sure to reset the clock. Once the surface controls have been set to the OFF positions and the clock has been set with the correct time of day, the surface controls should return to normal operation. If the surface controls do not function and the “Er” message remains in any display after following these procedures, contact an authorized Electrolux servicer.

ESEC Lockout Feature (- -)

The self-clean feature will not operate whenever a radiant surface element is ON. The ESEC feature will not operate during a self-clean cycle or when the Oven Lockout feature is active. Whenever the ESEC lockout feature is active, “- -” may appear in any display window (see figure 7). If any of the surface elements are still hot during active Lockout, “HE” will appear in the window instead of the “- -” message.

CAUTION Radiant surface elements may appear to have cooled after they have been turned off. **The glass surface may still be hot** and burns may occur if the glass surface is touched before it has cooled sufficiently.

CAUTION Do not place plastic items such as salt and pepper shakers, spoon holders or plastic wrappings on top of the range when it is in use. These items could melt or ignite. Potholders, towels or wooden spoons could catch fire if placed too close to the surface elements.

NOTE: Please read detailed instructions for ceramic glass cooktop cleaning in the **Ceramic Glass cooktop** section and **Avoid Service Checklist** section of this Use and Care Guide.

NOTE: Radiant elements have a limiter that allows the element to cycle on and off, even at the HI setting. This helps to prevent damage to the ceramic smooth top. Cycling at the HI setting is normal and can occur if the cookware is too small for the radiant element or if the cookware bottom is not flat (Refer to Surface Cooking Utensils section on page 9 for using correct cookware instructions with the cooktop).



Figure 6

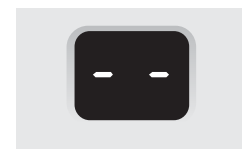

Figure 7

Surface Cooking (continued)

Ceramic Glass Cooktop (some models) (continued)

Models with Electronic Surface Element Controls (ESEC)

Hot Element Indicator Message (HE)

After using any of the single, dual or bridge radiant element positions the cooktop will become very hot. Even after turning the control knob to OFF, the cooktop will remain hot for some time. The ESEC control monitors the temperature of the cooktop and displays the message “HE” (hot element) warning when the cooktop is still too hot to touch (Fig. 1). If the HE message appears in the window, the control can be turned on again for use.

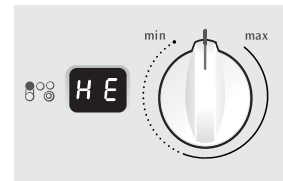

Figure 1

Operating (ESEC) Single Radiant Surface Elements

The cooktop has single radiant surface elements at 2 locations; the right rear (Fig. 3) and left rear (Fig. 4) element positions. The BRIDGE element position can also be used as a single element.

To Operate the Single Surface Elements:

1. Place correctly sized cookware on the radiant surface element.
2. Push in and turn the surface control knob in either direction to the desired setting using the ESEC digital display window for the desired setting (Fig. 2). Turn the knob to adjust the setting if desired. Start most cooking operations on a higher setting and then turn to a lower setting to finish cooking. Each surface element provides a constant amount of heat at each setting. A glowing red surface heating area extending beyond the bottom edge of the cookware indicates the cookware is too small for the surface heating area.
3. When cooking has completed, turn the surface control knob to OFF before removing the cookware. Note: The HE message will appear after turning the control knob to OFF if the cooktop is still hot and will remain on until heating surface area has cooled sufficiently.

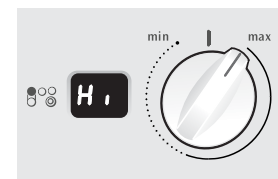

Figure 2

Appearance and graphics of cooktops may be different

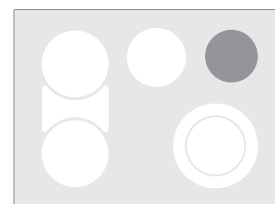

Figure 3
Right Rear Element

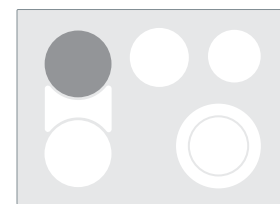

Figure 4
Left Rear Element

Operating the ESEC Dual Surface Radiant Elements (some models)

The cooktop is equipped with a dual radiant surface element located at the right front (Fig. 8) position. The size of graduations on control panel indicate which coil of the dual radiant element will heat. The **small** graduations indicates that only the inner coil will heat (Fig. 5 & 7). The **large** graduations indicates that both inner and outer coils will heat (Fig. 6 & 8). You may switch from either coil setting at any time during cooking.

To Operate the Dual Surface Elements:

1. Place correctly sized cookware on the radiant surface element.
2. Push in and turn the control knob counterclockwise (Fig. 5) for smaller cookware and clockwise (Fig. 6) for larger cookware.
3. Use the ESEC digital display window for the desired setting. Turn the knob to adjust the setting if needed. Start most cooking operations on a higher setting and then turn to a lower setting to finish cooking. Each surface element provides a constant amount of heat at each setting. A glowing red surface heating area extending beyond the bottom edge of the cookware indicates the cookware is too small for the surface heating area.
4. When cooking has completed, turn the surface control knob to OFF before removing the cookware. Note: The **HE** message will appear after turning the control knob to **OFF** if the cooktop is still hot and will remain on until the radiant surface area has cooled sufficiently.

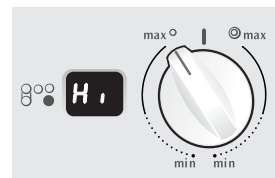

Figure 5

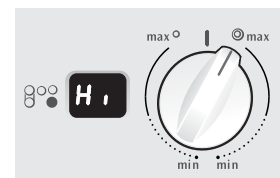

Figure 6

Appearance and graphics of cooktops may be different



Figure 7

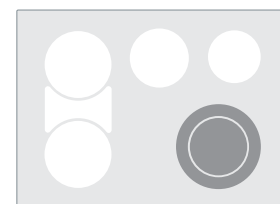

Figure 8

⚠ CAUTION Radiant surface elements may appear to have cooled after they have been turned off. **The glass surface may still be hot** and burns may occur if the glass surface is touched before it has cooled sufficiently.

Surface Cooking (continued)

Ceramic Glass Cooktop (some models) (continued)

Models with Electronic Surface Element Controls (ESEC)

Operating the ESEC Bridge Surface Radiant Element (some models)

The cooktop is equipped with a “Bridge” surface element located at the left front and middle positions. The Bridge can be used when cooking with rectangular (like a griddle) or oval shaped cookware. The element will maintain an even temperature setting across both portions of the Bridge. If needed for normal cookware, the Bridge element can work like a single element without the Bridge. Bridge element operation symbols are located on the control panel on each side of the Bridge element control knob. These symbols indicate the direction to turn the control knob when operating the Bridge element. The symbol in **figure 1** indicates that only the single portion of the Bridge element will heat (**see figure 3**). The symbol in **figure 2** indicates that both the single and Bridge portions of the element will heat together (**see figure 4**). You may switch from either of these settings at any time during cooking with the Bridge element.

To Operate the Bridge Surface Elements:

1. Place correctly sized cookware on the radiant surface element.
2. Push in and turn the surface control knob counterclockwise to heat the portion of the Bridge element for normal shaped cookware or clockwise for larger or rectangular shaped cookware.
3. Use the ESEC digital display window for the desired setting. Turn the knob to adjust the setting if needed. Start most cooking operations on a higher setting and then turn to a lower setting to finish cooking. Each surface element provides a constant amount of heat at each setting. A glowing red surface heating area extending beyond the bottom edge of the cookware indicates the cookware is too small. Please note that not all cookware will fit the Bridge element correctly.
3. When cooking has completed, turn the surface control knob to OFF before removing the cookware. Note: The HE message will appear after turning the control knob to OFF if the cooktop is still hot and will remain on until heating surface area has cooled sufficiently.

The BRIDGE element may also be used in combination with the left rear single element (**see figure 5**). Because these element have 2 different controls, one element can be used to cook while the other element may be used to keep food warm.

⚠ CAUTION Radiant surface elements may appear to have cooled after they have been turned off. **The glass surface may still be hot** and burns may occur if the glass surface is touched before it has cooled sufficiently.

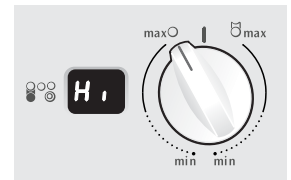

Figure 1

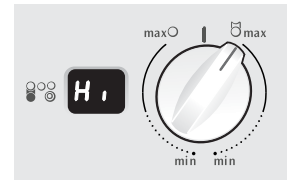

Figure 2

Appearance and graphics of cooktops may be different

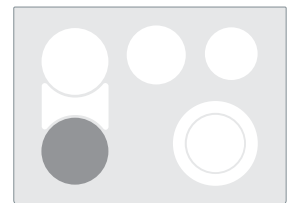

Figure 3

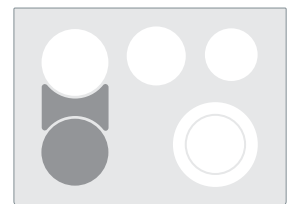

Figure 4

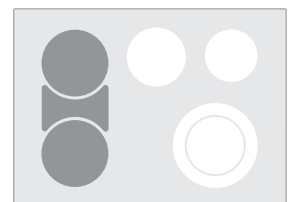

Figure 5

Surface Cooking (continued)

Ceramic Glass Cooktop (some models) (continued)

Setting Warm Zone Controls (some models)

To Operate the warm zone

Your appliance is equipped with a warm zone. The purpose of the warm zone is to keep hot cooked foods at serving temperature. Always start with hot food. It is not recommended to heat cold food on the warm zone.

Use the warm zone to keep cooked foods hot such as: vegetables, gravies, casseroles, soups, stews, breads, pastries and oven-safe dinner

All food placed on the warm zone should be covered with a lid or aluminum foil to maintain quality. For best results, when warming pastries or breads, the cover should have an opening to allow moisture to escape. **Do not use plastic wrap to cover food. Plastic may melt onto the surface and be very difficult to clean.**

Use only dishware, utensils and cookware recommended for oven and cooktop use on the warm zone.

CAUTION Unlike the surface elements, the warm zone will not glow red when it is hot. Always use potholders or oven mitts when removing food from the warm zone as cookware and plates will not be hot.

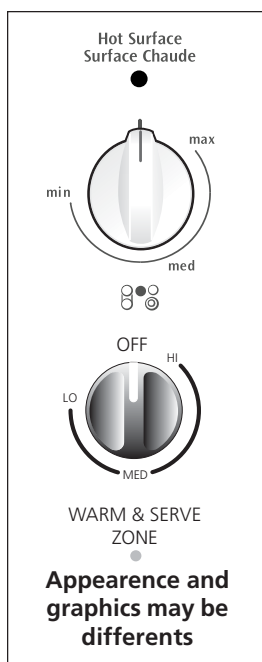

Indicator Lights

The **Hot Surface indicator light** is located above or below the warm zone control. It turns on when the control is set and will continue to glow until the glass cooktop has cooled down to moderate level.

To Set the Warm Zone Control

1. To set the control, push in and turn the knob. The temperatures are approximate, and are designated by MAX, MED and MIN. However, the control can be set at any position between HI and MIN for different levels of heating.
2. When done, turn the control to OFF position. The warm zone will remain warm until the **hot surface indicator light** goes off.

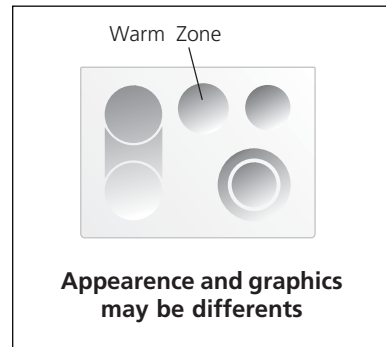

Temperature Selection





Refer to the chart for recommended heating levels. If a particular food is not listed, start with the medium level, and adjust as needed. Most food can be kept at serving temperatures by using the medium level.

Warm Zone Recommended Food Settings Chart			
<u>Food Item</u>	<u>Heating Level</u>	<u>Food Item</u>	<u>Heating Level</u>
Breads/Pastries	MIN	Sauces	MED
Casseroles	MIN	Soups (cream)	MED
Dinner Plate with Food	MIN	Stews	MED
Eggs	MIN	Vegetables	MED
Gravies	MIN	Fried Foods	MAX
Meats	MED	Hot Beverages	MAX
		Soups (liquid)	MAX

Oven Baking

For best cooking results, heat the oven before baking cookies, breads, cakes, pies or pastries, etc... There is no need to preheat the oven for roasting meat or baking casseroles.

The cooking times and temperatures needed to bake a product may vary slightly from your previously owned appliance.

Baking Problems and Solutions Chart		
Baking Problems	Causes	Corrections
Cookies and biscuits burn on the bottom. 	<ul style="list-style-type: none"> • Cookies and biscuits put into the oven before the preheating time is completed. • Oven rack overcrowded. • Dark pan absorbs heat too fast. 	<ul style="list-style-type: none"> • Allow oven to preheat to the selected temperature before placing food in oven. • Choose pan sizes that will permit 5.1 cm to 10.2 cm (2" to 4") of air space on all sides when placed in the oven. • Use a medium-weight aluminum baking sheet.
Cakes too dark on top or bottom. 	<ul style="list-style-type: none"> • Cakes put into the oven before pre-heating time is completed. • Rack position too high or low. • Oven too hot. 	<ul style="list-style-type: none"> • Allow oven to preheat to the selected temperature before placing food in the oven. • Use proper rack position for baking needs. • Set oven temperature 25°F/12°C lower than recommended.
Cakes not done in the center. 	<ul style="list-style-type: none"> • Oven too hot. • Incorrect pan size. • Pan not centered in oven. 	<ul style="list-style-type: none"> • Set oven temperature 25°F/12°C lower than recommended. • Use pan size suggested in recipe. • Use proper rack position and place pan so there is 5.1 cm to 10.2 cm (2" to 4") of space on all sides of pan.
Cakes not level. 	<ul style="list-style-type: none"> • Range not level. • Pan too close to oven wall or rack overcrowded. • Pan warped. 	<ul style="list-style-type: none"> • Place a marked glass measuring cup filled with water on the center of the oven rack. If the water level is uneven, refer to the installation instructions for leveling the range. • Be sure to allow 5.1 cm to 10.2 cm (2" to 4") of clearance on all sides of each pan in the oven. • Do not use pans that are dented or warped.
Foods not done when cooking time is up. 	<ul style="list-style-type: none"> • Oven too cool. • Oven overcrowded. • Oven door opened too frequently. 	<ul style="list-style-type: none"> • Set oven temperature 25°F/12°C higher than suggested and bake for the recommended time. • Be sure to remove all pans from the oven except the ones to be used for baking. • Open oven door only after shortest recommended baking time.

Air Circulation in the Oven

For good air circulation in the oven and best baking results, center pans as much as possible. Allow 5.1 to 10.2 cm (2" to 4") around the utensil(s) for proper air circulation and be sure pans do not touch each other, the door, sides or back of oven. The hot air must circulate around the pans for even heat to reach all parts of the oven.

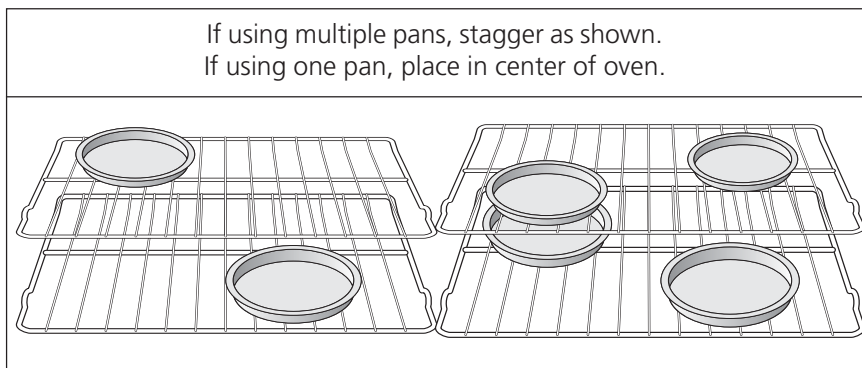

Convection Cooking (some models)

NOTE: The convection fan automatically turns off when the oven door is opened while oven is in a convection mode and resumes when the door is closed again.

The convection oven uses a fan located in the rear wall of the oven to circulate heated air around the food to be cooked. The controlled air flow pattern quickly seals the food surface retaining the natural juices and flavour. This method of cooking enables you to obtain the best culinary results when baking, thawing, dehydrating and roasting foods.

Convection notes:

1. Most recipes can be made with temperatures set at 13°C (25°F) lower than temperatures required for normal radiant cooking methods. Refer to the electronic oven control operating instructions included in section "Electronic Oven Control Guide" of this Use & Care Guide. This can result in considerable reduction of food shrinkage and more tender meats.
2. Batch cooking is more convenient with better results.
3. Defrosting is quicker in convection mode when compared to regular radiant cooking.
4. Remember to use tested recipes with times adjusted for convection baking/roasting when using the convection mode. Times may be reduced by as much as 30% when using the convection feature.

Convection Roasting (some models)

When convection roasting, use the broiler pan and grid, and the roasting rack. The broiler pan will catch grease spills and the grid will help prevent grease splatters. The roasting rack will hold the meat.

1. Place oven rack on bottom or next-bottom rack position.
2. Place the grid in the broiler pan. The roasting rack fits on the grid allowing the heated air to circulate under the food for even cooking and helps to increase browning on the underside. Make sure the roasting rack is securely seated on the grid in the broiler pan. DO NOT use the broiler pan without the grid or cover the grid with aluminum foil.

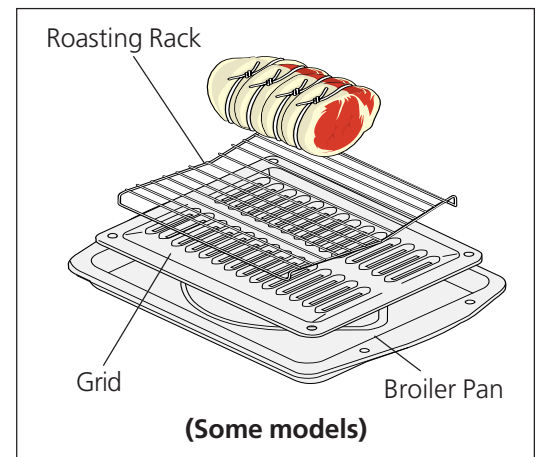

Speed Bake™ Cooking System (some models)

Speed Bake™ Cooking System uses a fan to circulate the oven's heat uniformly and continuously around the oven. This improved heat distribution allows for fast, even cooking and browning results. It also gives better baking results when using two racks at the same time.

Heated air flows around the food from all sides, sealing in juices and flavors. Meats cooked with **Speed Bake™ Cooking System** are juicier. Poultry is crisp on the outside while staying tender and moist on the inside. Breads and pastry brown more evenly. Most foods baked in a standard oven can be cooked faster and more evenly with **Speed Bake™ Cooking System**.

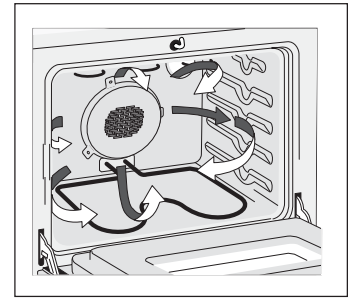

Benefits of Speed Bake™ Cooking System:

- Foods cook up to 30% faster, saving time and energy.
- Two racks can be used with more even cooking and browning.
- No special pans or bakeware needed.

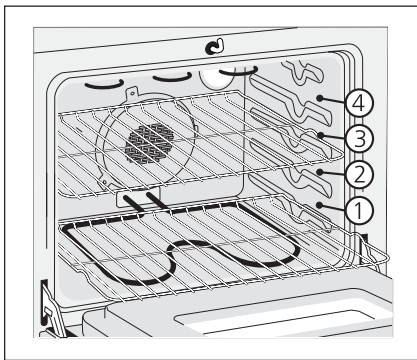

General Cooking Instructions:

1. To convert baking times from normal recipes to **Speed Bake** times, start with a 30% reduction in time and increase the time until desired doneness is obtained. Time reductions will vary depending on the amount and type of food.
2. Preheating is not necessary when cooking with **Speed Bake**, except with items such as cakes, cookies, biscuits, breads, etc.
3. When using two racks at the same time, place them in positions 1 and 3 for the best results.
4. When baking cakes with **Speed Bake**, set temperature 25°F (13°C) degrees lower than the recommended setting for best results.

To Set Speed Bake™ Cooking System:

1. Program the oven as you normally would for baking. Speed Bake may be used with Bake, Time Bake and Delayed Time Bake modes.
2. Turn the **Speed Bake** switch to **ON** position. The indicator light will glow and the fan will come on. The fan stays on when oven door is closed and shuts off while the oven door is opened. The fan will continue to operate until baking is complete.
3. When using **Speed Bake** feature along with the Delayed Timed Bake mode, the fan will begin to operate when the control is set. The oven elements will not begin to operate until the Delayed Start Time is reached. This operation is normal.
4. To cancel Speed Bake function, push **CANCEL** on the oven control as you would to cancel any baking function.

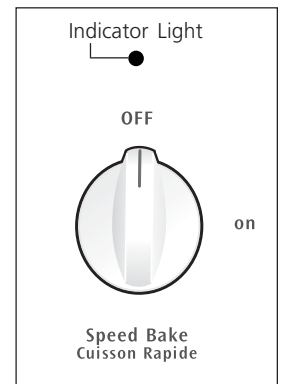

Note: Speed Bake mode will not work during a clean cycle.

Recommended Foods for Speed Bake™ Cooking System	
Food Item	Decrease Cook Time by:
Casseroles	25%
Meats	15% (or 5 mins/pound)
Poultry	30% (or 10 mins/pound)
Frozen Foods	20%
Refrigerator Cookies or Biscuits	25% (or 2 to 5 min.)
Rolls/Breads/Pizza	25% (or 5 min.)
Vegetables	25%
Baked potatoes	25%
Pies/Pastries	30%

Broiling

Broiling is a method of cooking tender cuts of meat by direct heat under the broil element of the oven.

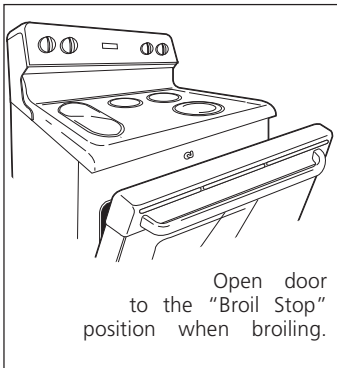

Always pull oven rack out to the "stop" position before turning or removing food.

Preheating

Preheating is suggested when searing rare steaks. (Remove all utensils from the oven before preheating. Foods will stick if placed on hot metal.) To preheat, set the oven control(s) to BROIL as instructed in the Owner's Guide. Wait for the element to become red-hot, usually about 2 minutes. Preheating is not necessary when broiling meats well-done.

To Broil

Broil on one side until the food is browned; turn and cook on the second side. Season and serve. Always pull rack out to the "stop" position before turning or removing food.

Determining Broiling Times

Broiling times vary, so watch the food closely. Time not only depends on the distance from the element, but on the thickness and aging of meat, fat content and doneness preferred. The first side usually requires a few minutes longer than the second. Frozen meats also require additional time.

Broiling Tips (some models)

The broiler pan and its grid allow dripping grease to drain and be kept away from the high heat of the broiler.

DO NOT use a pan without its grid. **DO NOT** cover the grid with foil. The exposed grease could ignite.

CAUTION Should an oven fire occur, close the oven door and turn off the oven. If the fire continues, throw baking soda on the fire or use a fire extinguisher. **DO NOT** put water or flour on the fire. Flour may be explosive.

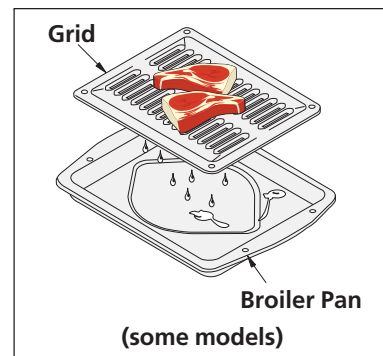

Broiler Clean-Up Tips (some models):

- To make cleaning easier, line the bottom of the broiler pan with aluminum foil. **DO NOT** cover the broiler grid with foil.
- To prevent grease from baking on, remove the broiler pan from the oven as soon as cooking is completed. Use hot pads because the broiler pan is extremely hot. Pour off grease. Soak the pan in HOT, soapy water.
- Clean the broiler pan as soon as possible after each use. If necessary, use soap-filled steel wool pads. Heavy scouring may scratch the grid.

Oven Settings

For oven settings, refer to the timer section or the electronic oven control.

General Cleaning

Cleaning Various Parts of Your Range

Before cleaning any part of the range, be sure all controls are turned OFF and the range is cool. Remove spillovers and heavy soiling as soon as possible. Regular cleaning will reduce the effort required for major cleaning later.

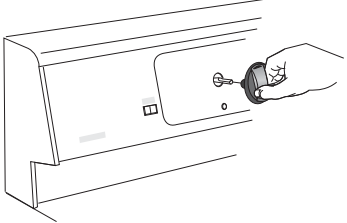
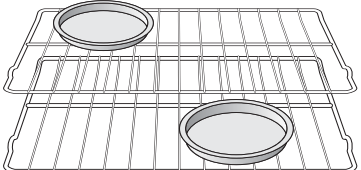
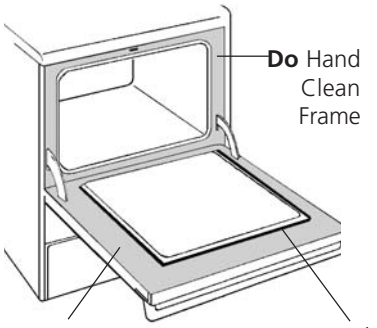
Surfaces	How to Clean
Vinyl and Aluminum (Trim Pieces)	Use hot, soapy water and a cloth. Dry with a clean cloth.
Control Panel 	<p><i>Before cleaning the control panel,</i> turn all controls to OFF and remove the control knobs. To remove, pull each knob straight off the shaft. Clean using hot, soapy water and a dishcloth. Be sure to squeeze excess water from the cloth before wiping the panel; especially when wiping around the controls. Excess water in or around the controls may cause damage to the appliance. To replace knobs after cleaning, line up the flat sides of both the knob and the shaft; then push the knob into place.</p>
Stainless Steel Control panel, Oven door and Drawer front panel	Cleaners made especially for stainless steel as Stainless Steel Magic, or other similar cleaners are recommended. Always follow the manufacturer's instructions. Be sure to rinse the cleaners as bluish stains may occur during heating and cannot be removed.
Oven Racks 	Remove racks. Use a mild, abrasive cleaner, following manufacturer's instructions. Rinse with clean water and dry. After cleaning the racks, rub the sides of the racks with wax paper or a cloth containing a small amount of baby oil or salad oil (this will make the racks glide easier into the rack positions).
Cooktop, under Cooktop, Broiler Pan and Insert (some models), Door Liner, Small Oven	Gentle scouring with a soapy scouring pad will remove most spots. Rinse with a 1:1 solution of clear water and ammonia. <i>If necessary,</i> cover difficult spots with an ammonia-soaked paper towel for 30 to 40 minutes. Rinse with clean water and a damp cloth and then scrub with a soap-filled scouring pad. Rinse and wipe dry with a clean cloth. Remove all cleaners or the porcelain may become damaged during future heating. DO NOT use spray oven cleaners on the cooktop.
Oven Door 	<p>To clean oven door, wash with hot, soapy water and a clean cloth. DO NOT immerse the door in water.</p> <p>DO NOT clean the oven door gasket. The oven door gasket is made of a woven material which is essential for a good seal. Care should be taken not to rub, damage or remove the gasket.</p>

General Cleaning

Ceramic Glass Cooktop (some models)

Special Caution for Aluminum Foil and Aluminum Cooking Utensils

1) Aluminum foil

Use of aluminum foil will damage the cooktop. Do not use under any circumstances.

2) Aluminum utensils

The melting point of aluminum being much lower than that of other metals, care must be taken when aluminum pots or pans are used. If allowed to boil dry, not only will the utensil be ruined, but also permanent damage in the form of breakage, fusing or marking may affect the ceramic glass surface.

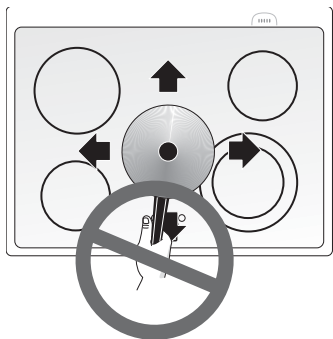

Sliding aluminum or copper clad bottom pans on the cooktop can cause metal markings on the cooktop surface. These marks should be removed **immediately** after the cooktop has cooled using the cooktop cleaning cream. Metal marks can become permanent if not removed prior to future use.

Cookware (cast iron, metal, ceramic or glass) with rough bottoms can mark or scratch the cooktop surface. **Do not slide anything metal or glass** across the cooktop. **Do not** use your cooktop as a cutting board or work surface in the kitchen. **Do not** cook foods directly on the cooktop surface without a pan.

Do not drop heavy or hard objects on the glass cooktop, they may cause it to crack.

Appearance and graphics of cooktops may be different

Things to Remember

1. AVOID using bleach and don't use ammonia to clean the ceramic surface.
2. Do not put plastic items on warm cooking areas.
3. Never slide oven racks across cooktop surface. They may scratch or metalmark the cooktop.
4. **If cooktop should break, do not use cooktop or attempt to clean it. Call your authorized service technician immediately.**
5. Never use a trivet or metal stand between the cooking utensil and the ceramic cooktop. The ceramic surface may be scratched, metal marked or etched by such items.
6. Sugary spills can cause pitting of your cooktop surface. Therefore, you must begin cleaning the spills while the cooktop is still hot. Use caution when following the steps below.
 - a) Turn off all surface units and remove all pans immediately.
 - b) Wearing an oven mitt, use a razor blade scraper to scrape the hot spill out of the cooking zone to a cooler area on the cooktop.
 - c) Allow the cooktop to cool.

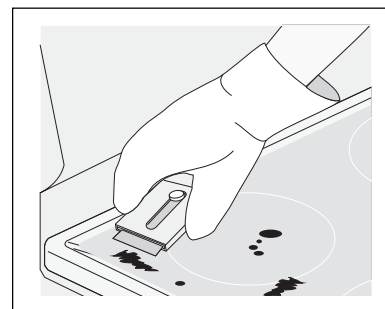

Use and Care of Glass Surface

Problem	Cause	To Prevent	To Remove
Fine "brown lines" (tiny scratches or abrasions which have collected soil)	Coarse particles (salt, sand, sugar or grit) between bottom of cookware and cooktop that are not removed before cooking. Using incorrect cleaning materials.	Clean cooktop after every use. Daily use of cleaner cream.	Tiny scratches are not removable. They can be minimized by continual use of cleaner cream. Such scratches do not affect cooking.
Metal marking (mark or black marks).	Sliding or scraping metal utensils or oven shelves across cooktop.	Do not slide cookware across cooktop.	Apply cleaner cream with dampened paper towel to a cooled surface.
Brown streaks and specks.	Cleaning with a sponge or dishcloth that has been used for other kitchen tasks.	Use cleaner cream with clean, damp paper towel.	Use a small amount of cleaner cream with clean, damp paper towel.

NOTE: Due to the high intensity of heat generated by the surface elements, the glass surface will turn green when the element will be turned off. This phenomenon is normal and the glass will come back to its original white color after it has completely cooled down. (White glass cooktops only).

General Cleaning (continued)

Ceramic Glass Cooktop (some models) (continued)

Use and Care of Glass Surface (continued)

Cleaning Materials for Ceramic Glass Cooktop

Some cleaning materials may contain an ingredient which can damage the cooktop. Use recommended materials only (see below). Cleaner cream should be used regularly. Prior to using your cooktop for the first time, apply a cleaner cream to the ceramic surface. Recommended cleaner cream are available in stores if needed.

Use only recommended cleaning products and follow these basic cleaning suggestions.

1. BEFORE THE COOKTOP IS USED. Thoroughly clean and saturate the cooktop with cleaner cream.
 - a) Dampen clean paper towel and clean unit.
 - b) Wipe off with another clean, damp paper towel; then wipe dry.
2. For normal daily cleaning, apply a dab of cleaner cream in the center of each unit-area to be cleaned. Start with approximately 1/8 teaspoon. (Apply more if needed). Then, proceed as stated above in (a and b).
3. Make sure bottom of cookware and cooking area are clean and dry.
4. Select heat settings and cookware large enough for food and liquid. This stops boilovers and splatterings.
5. Wipe up food spills and spatters before they burn into surface.

IMPORTANT Regularly use cleaner cream. If you run out of cleaner cream, use one of the cleansers listed. Be sure to get a new supply of cleaner cream.

⚠ CAUTION Never mix cleaning products! Mixtures may interact, with damaging or hazardous results.

Do Use on Ceramic Glass Cooktop

1. Baking soda.
2. Non-impregnated plastic and nylon pads.
3. For burned on material, scrape with single-edged razor blade, held at a 30° angle.
4. Ceramic glass cleaning cream.
5. **CERAMA BRYTE®** cleaner cream.

Do not Use on Ceramic Glass Cooktop

1. Avoid pads, that can leave marks and scratches.
2. Avoid heavy-duty cleansing powders, these can scratch, depending on their abrasiveness and cleaning pressure applied.
3. Avoid chemical oven cleaners. These can etch the cooktop surface and are caustic.
4. Avoid rust stain removers containing hydrofluoric acid.
5. Avoid using bleach and don't use ammonia.

Special Cleaning Instructions for Mineral Deposits and Discolorations

Problem: A gray brown stain that is not removed when using cleaner cream.

Cause: Condensation, when cooking, often collects and drips from cookware. The minerals found in water supply and foods may cause a gray or brown film to develop on cooktop. This film is so thin it cannot be felt and appears to be under cooktop.

To Prevent: Daily and proper use of cleaner cream.

To Remove:

- Wet surface with water and sprinkle on cleaner cream.
- Scrub with clean, damp paper towel until stain disappears.
- Clean remaining paste away with damp paper towel.
- Apply dab of cleaner cream and polish with a clean paper towel.

WARNING

- Do not use cleansers on a heated surface. Fumes could be hazardous. Wait for area to cool before cleaning.
- Do not use cleaner cream to clean porcelain, paint or aluminium.

Care and Cleaning of Stainless Steel (some models)

Special care and cleaning are **required** for maintaining the appearance of stainless parts. Please refer to the table at the beginning of the **General Cleaning** section in this Use and Care Guide.

General Cleaning (continued)

Cleaning the Appliance

Before cleaning any part of the range, make sure all heating elements are turned to OFF and are cool.

Exterior Cleaning

Clean range after each use to prevent sticky grease built-up and spills from cooking on. Wash with hot, soapy water and a clean cloth. Wipe with a soft cloth or paper towel.

Do not use abrasives, steel wool, cleaners containing ammonia, acids or commercial oven cleaners on any exterior parts of the range, except the porcelain enamel cooktop. If a metal cleaner or polish is used on metal trim, be sure the label specifies that it is safe for use on chrome and aluminium.

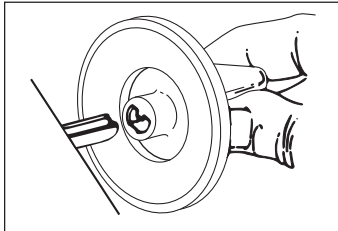

Steel/Aluminum Control Panel

Control knobs (some models)

If the control panel needs cleaning turn the control knobs to **OFF**, then pull knobs straight off the shafts.

Most cleaning of your steel/aluminum control panel can be done using a clean cloth with warm soapy water or other mild household cleaners.

Sometimes, applying few drops of a recommended cooktop cleaning/polishing cream (with silicone) will remove any remaining soil and will leave a protective coating which will keep your range looking like new.

Cooktop cleaning/polishing cream can be purchased through authorized service centers or major department stores.

Glass Control Panel:

Use a clean cloth or a sponge with warm, soapy water or paper towel and spray glass cleaner to clean the glass panel. Be careful not to let water/cleaner go behind the glass or near the knob activated controls.

Replace knobs; engage the flat surface inside the knob cavity with the flat on the shaft. Push knobs onto the shafts.

Prior to cleaning the coil elements make sure they are cold and that control knobs are turned to OFF "●".

⚠ WARNING Never leave covers on the coil elements as they could be permanently damaged if the coil is turned on by accident.

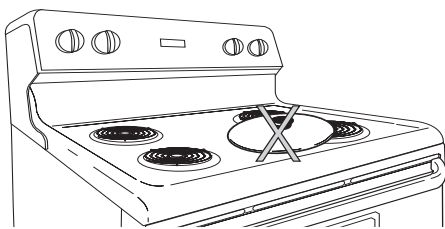

Coil Surface Elements (some models)

Coil Elements and Drip Bowls

Coil elements clean themselves when they are turned on.

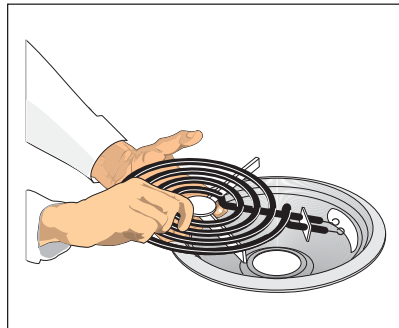

Coil elements and drip bowls are removable and allow to clean the drip bowls.

To remove a coil element, push against the front edge and lift element up and out.

To clean by hand, wash the drip bowls in hot sudsy water. For hard to remove spots, use a nylon scrubber with soap. Rinse and dry while still warm.

⚠ WARNING Never immerse coil elements in water.

SURFACES	CLEANING AGENTS	INSTRUCTIONS
Porcelain Enamel (Cooktop, Surface under cooktop)	Mild Cleaners or soap-filled steel wool pads	Use a damp sponge or dampened soap pad, rinse and dry
Insert – Control panel	Hot, soapy water or cleaner cream	Use a clean, soapy, dampened cloth or paper towel, remove soil and dry. Do not use abrasive products.

General Cleaning (continued)

Cleaning the Appliance (continued)

⚠ WARNING DO NOT use a cooktop cleaner on a hot cooktop. The fumes can be hazardous to your health, and can chemically damage the cooking surface.

⚠ CAUTION Before Cleaning the surface cooktop, be sure the controls are turned to OFF and the cooktop is cool.

⚠ CAUTION DO NOT use commercial oven cleaners on the exterior surfaces including rangetop and door frame.

Porcelain Enamel Cooktop Cleaning Instructions.

Porcelain Enamel Cooktop Cleaning

Correct and consistent cleaning is essential to maintaining your porcelain enamel cooktop. If food spills and grease spatters are not removed, they may burn onto the surface of the cooktop and cause permanent discoloration.

Daily Cleaning

For normal soil:

1. Allow cooktop surface to cool.
2. Wipe off spills and spatters using a clean paper towel or a clean cloth with warm, soapy water.
3. If needed, use a soapy steel wool pad or other mild household cleaners.
4. Be sure to rinse off the cleaners or the porcelain may become damaged during future heating.

For heavy, burned-on soil:

1. Allow cooktop surface to cool.
2. Use a soap filled scouring pad with warm water or cover heavily soiled spots with a solution of clear water and ammonia. Scour gently. Rinse and wipe dry with a clean cloth.
3. If any soil remains, apply a few drops of a recommended cooktop cleaning cream on the spots and rub gently using a clean damp cloth or scouring pad. Buff with a dry cloth until all soil and cream are removed. Frequent cleaning with the cooktop cleaning cream leaves a protective coating which helps in preventing scratches and abrasions.

For sugary spillovers:

Sugary spills can chemically damage your cooktop surface. Therefore, you must begin cleaning the spills while the cooktop is still hot. Use caution when following the steps below.

1. Turn off all surface units and remove all pans immediately.
2. Wearing an oven mitt, wipe up carefully or move hot spills away from the element area with a clean damp cloth.
3. Allow the cooktop to cool. Follow the instructions above for heavy, burned-on soil.

COOKTOP CLEANING/POLISHING CREAM can be purchased through authorized service centers or major department stores.

General Cleaning (continued)

Cleaning the Appliance (continued)



Cleaning the Regular Oven (Non self-clean oven)

Make sure the oven is cool and that all control knobs are at **OFF** position. Cleaning the oven is a lot easier when the door is removed.

1. Remove the oven door; see “**To Remove and Replace Oven Door**” section in this manual.
2. Empty the oven including the racks.
3. You can wash the broiler pan, grid and racks (some models) in the kitchen sink.
4. Clean oven lining thoroughly with soap and a wet cloth and wipe with a dry cloth.

To remove burned-on fat on oven walls, moisten soiled parts with household ammonia, using a wet cloth. Follow suggested manufacturer’s cleaning method. (Do not remove the oven door when using ammonia.)

Complete cleaning with a damp cloth and use a fine steel wool or scouring agent if necessary. The lower element can be moved up for cleaning purposes.

5. Replace racks in the oven. Reinstall oven door.

Cleaning the Self-Clean Oven (some models)

Adhere to the following cleaning precautions:

- Allow the oven to cool before cleaning.
- Wear rubber gloves when cleaning any exterior parts of the oven manually.

CAUTION During the self-cleaning cycle, the outside of the wall oven can become very hot to the touch. **DO NOT** leave small children unattended near the appliance.

CAUTION The health of some birds is extremely sensitive to the fumes given off during the self-cleaning cycle of any range. Move birds to another well ventilated room.

CAUTION Before cleaning any part of the oven, be sure the electronic oven control is turned off or else push **CANCEL** pad. Wait until the oven is cool.

DO NOT use commercial oven cleaners or oven protective coatings in or around any part of the self-cleaning oven. **DO NOT** clean the oven door gasket. The gasket on the oven door is essential for a good seal. Care should be taken not to rub, damage or move the gasket. **DO NOT** use any cleaning materials on the gasket. Doing so could damage it. **DO NOT** use aluminum foil to line the oven bottom. This may affect cooking or foil could melt and damage the oven surface.

A self-cleaning oven cleans itself with high temperatures (well above cooking temperatures) which eliminate soil completely or reduce it to a fine powdered ash you can whisk away with a damp cloth.

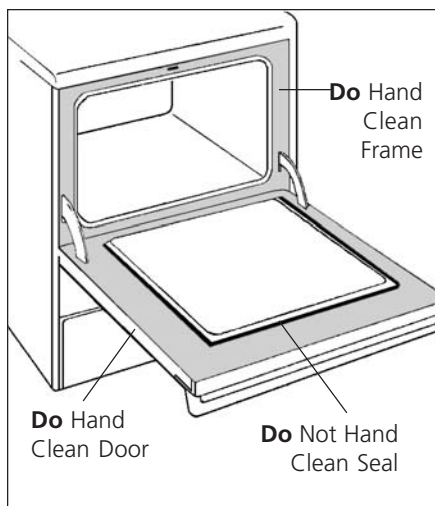

Preparing the Oven for Self-Cleaning

1. Remove any excess spillovers in the oven cavity before starting the self-cleaning cycle. To clean, use hot soapy water and a cloth. Large spillovers can cause heavy smoke or fire when subjected to high temperatures. **DO NOT** allow food spills with a high sugar or acid content (such as tomatoes, sauerkraut, fruit juices or pie filling) to remain on the surface as they may cause a dull spot even after cleaning.
2. Clean any soil from the oven frame and the door liner (see illustration). These areas heat sufficiently during a self-clean cycle to burn soil on. Clean with soap and water.
3. Remove all utensils and any foil. These items do not withstand high cleaning temperatures.
4. Oven racks may be left in the oven or may be removed. If they go through the clean cycle, their colour will turn slightly dull. After the cycle is completed and the oven has cooled, rub the sides of the racks with wax paper or a cloth containing a small amount of baby oil or salad oil. This will make the racks glide easier.

General Cleaning (continued)

Cleaning the Appliance (continued)

⚠ WARNING DO NOT use the surface element in self-clean mode.

During the self-clean cycle, the surface elements, when used, are subjected to high heat. To ensure maximum element life, do not use the surface element during a self-clean cycle.

What to Expect During Cleaning

While the oven is in operation, the oven heats to temperatures much higher than those used in normal cooking. Sounds of metal expansion and contraction are normal. Odor is also normal as the food soil is being removed. Smoke may appear through the oven vent, located on the top of the control panel.

If heavy spillovers are not wiped up before cleaning, they may flame and cause more smoke and odor than usual. This is normal and safe and should not cause alarm. If available, use an exhaust fan during the self-cleaning cycle.

NOTE: A smoke eliminator in the oven vent converts most of the soil into a colourless vapor.

Setting the Controls for a Clean Cycle

For the setting of the clean cycle, refer to the section on the timer or Electronic oven control.

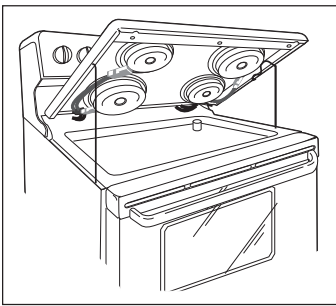

Upswept lift cooktop (some models)

On some models, the cooktop, when equipped with coil elements, can be raised to facilitate cleaning of the panel.

To raise the cooktop, grab the sides and lift from the front. Use the two sliding wire supports located on each side of the cooktop and pull them toward you, to the lock position, in order to maintain the cooktop in the raised position while cleaning the panel.

⚠ CAUTION Lower the cooktop slowly; be careful not to pinch fingers. Do not let the cooktop fall freely, as this may damage the porcelain finish.

To Remove and Replace the Oven Door

1. Open the door fully.
2. Pull up the lock located on both hinge supports and engage them in the hook of the hinge levers. You may have to apply a little downward pressure on the door to pull the locks fully over the hooks.
3. Grab the door by the sides, pull the bottom of the door up and toward you to disengage the hinge supports.

Keep pulling the bottom of the door toward you while rotating the top of the door toward the range to completely disengage the hinge levers.

4. Proceed in reverse to reinstall the door.
Make sure the hinge supports are fully engaged before unlocking the hinge levers.

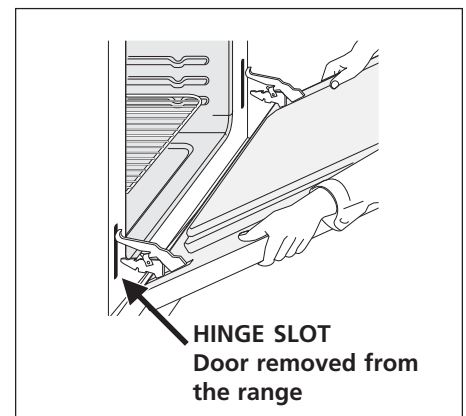
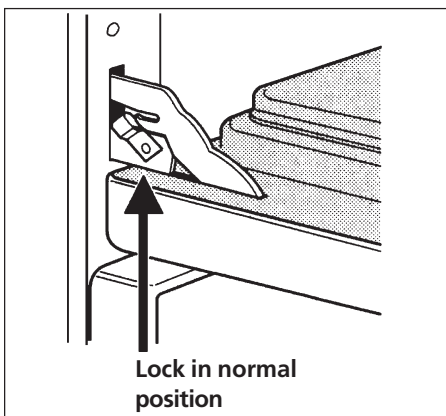

Removable Outer Door Glass Panel (some models)

Applicable only to models with an external glass panel not held with a frame. This design allows you to clean the inside face of the exterior door panel as well as the hidden face of the door inner glass. There are two different kinds of glass panel; one with a lower metal trim fixed on the underside of the glass panel and the other one with a lower metal support rail.

To remove the external door glass panel:

1. Pull the door off the range as per instructions under **"To Remove and Replace Oven Door"** in "Cleaning the Appliance" section and lay the door flat.
2. Using a screwdriver, remove the screws fastening the glass lower metal trim or the glass assembly.
3. Grab both sides of the glass panel and slowly pull it out of the door upper moulding. Lay the glass flat.

CAUTION Handle the glass panel with care. When dropped on a corner the glass panel may shatter in multiple fragments and you could get hurt.

CAUTION DO NOT remove the lower metal trim, which is fixed on the underside of the glass panel.

To replace the external door panel:

1. Grab the sides of the glass panel and carefully insert the glass into the door top moulding.
2. Replace the glass lower trim or the glass assembly using the locking screws.
3. Replace the door onto the range as per **"To Remove and Replace Oven Door"** in "Cleaning the Appliance" section.

To Remove and Replace Storage Drawer

To remove the Drawer:

Push down the left latch and pull up the right latches. Pull drawer out of range.

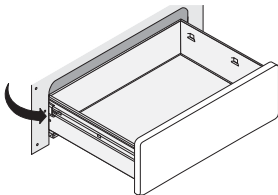

To Remove/Replace the Storage Drawer with Extendable Glides (some models)

Use the storage drawer for storing cooking utensils. The drawer can be removed to facilitate cleaning under the range. Use care when handling the drawer.

To Remove the Drawer:

1. Pull out the empty drawer until it stops.
2. Push down the left glide latch and pull up the right glide latch.
3. Pull drawer out of the range.

To Replace the Drawer:

1. Slide the drawer rails over the glides.
2. Push the drawer back into the range.

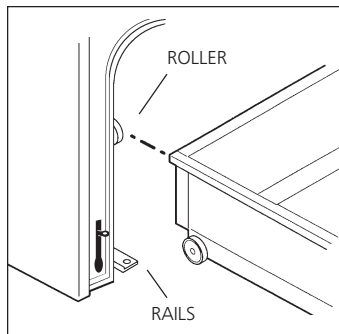

To Remove/Replace the Storage Drawer with Rollers (some models)

To Remove the Drawer:

1. Pull the empty drawer out to the roller guide stop.
2. Tilt the drawer up and pull it out over the rollers.

To Replace the Drawer:

1. Insert the rear end of the drawer into the opening.
2. Fit the drawer end rollers onto the guide rails.
3. Push the drawer in until it stops, then lift to allow the rollers to clear the roller guide stop, and push in.

Warmer Drawer (some models)

Setting Warmer Drawer Controls

To Operate the Warmer Drawer

Your range is equipped with a warmer drawer. The purpose of the warmer drawer is to keep hot cooked foods at serving temperature. Always start with hot food. It is not recommended to heat cold food in the warmer drawer.

All food placed in the warmer drawer should be covered with a lid or aluminum foil to maintain quality. **Do not cover crisp foods. Do not use plastic wrap to cover food. Plastic may melt onto the drawer and be very difficult to clean.**

Use only dishware, utensils and cookware recommended for oven use in the warmer drawer.

CAUTION Always use potholders or oven mitts when removing food from the warmer drawer as cookware and plates are hot.

Note: Use the warmer drawer to keep hot foods hot such as: vegetables, gravies, meats, casseroles, biscuits and rolls, pastries and heated dinner plates.

Note: The warmer drawer is equipped with a catch which may require extra force when opening and closing the drawer.

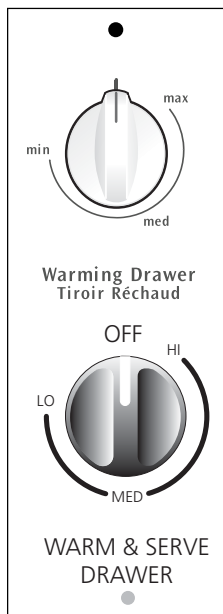

Indicator Light

The indicator light is located below the thermostat control. It turns on when the control is set, and stays on until the control is turned off. The warmer drawer is inoperable during the self-clean cycle. The indicator light will not come on during the self-clean cycle.

To Set the Thermostat Control

The thermostat control is used to select the temperature of the warmer drawer. It is located on the control panel. To set the thermostat, push in and turn the knob to the desired setting. The temperatures are approximate, and are designated by MAX, MED and MIN. The control can be set to the three settings, or anywhere between.

1. Select the temperature setting.
2. For best results, preheat the drawer before adding food. An empty drawer will reach the HI setting in about 18 minutes, the Med setting in about 15 minutes and the MIN setting in about 12 minutes.
3. When done, turn the thermostat control to OFF position.

Appearance and graphics may be different

Temperature Selection

Refer to the chart in the side column for recommended settings. If a particular food is not listed, start with the medium setting. If more crispness is desired, remove the lid or aluminum foil.

Most foods can be kept at serving temperatures by using the medium setting.

When a combination of foods are to be kept warm (for instance, a meat with 2 vegetables and rolls), use the high setting.

Refrain from opening the warmer drawer while in use to eliminate loss of heat from the drawer.

To Warm Serving Bowls and Plates

Heat bowls and plates on the MIN setting. Place empty dishes on the rack to raise them off drawer bottom. To further heat dishes or to heat fine china, check with the manufacturer for maximum heat tolerance.

IMPORTANT: The warmer drawer will be turned off automatically when the oven is in a self-cleaning mode. The warmer drawer can be used immediately after the clean cycle is ended.

Warmer Drawer Recommended Food Settings Chart

<u>Food Item</u>	<u>Setting</u>
Bacon	MAX
Biscuits	MED
Casseroles	MED
Eggs	MED
Empty Dinner Plates	MIN
Fish, Seafood	MED
Fried Foods	MAX
Gravies	MED
Ham	MED
Hamburger Patties	MAX
Pancakes, Waffles	MAX
Pastries	MED
Pies	MED
Pizza	MAX
Pork Chops	MAX
Potatoes (baked)	MAX
Potatoes (mashed)	MED
Poultry	MAX
Roasts (Beef, Pork, Lamb)	MED
Rolls, soft	MIN
Rolls, hard	MED
Vegetables	MED

Warmer Drawer (some models)

Arranging Warmer Drawer Rack Positions

Set the warmer drawer rack in the vertical position as shown below.

The rack can be used in 2 ways:

- In the **upright position** to allow low profile food items to be placed both under and on top of the rack (for example, rolls or biscuits on top of the rack and a casserole dish under).
- In the **downward position** to allow you to place light weight food items and empty dishware (for example, rolls or pastries and dinner plates).

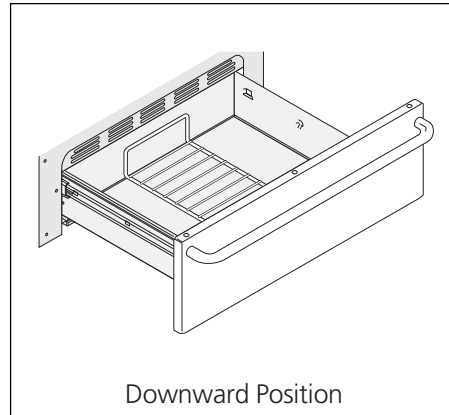
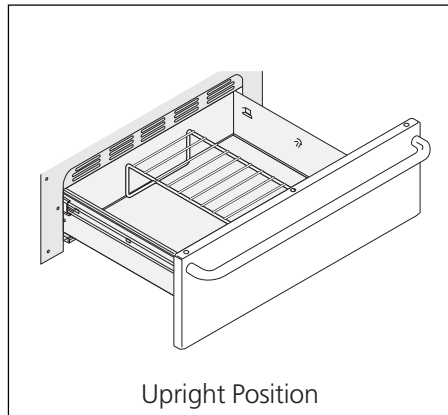

Warmer Drawer General Cleaning To Remove and Replace Warmer Drawer

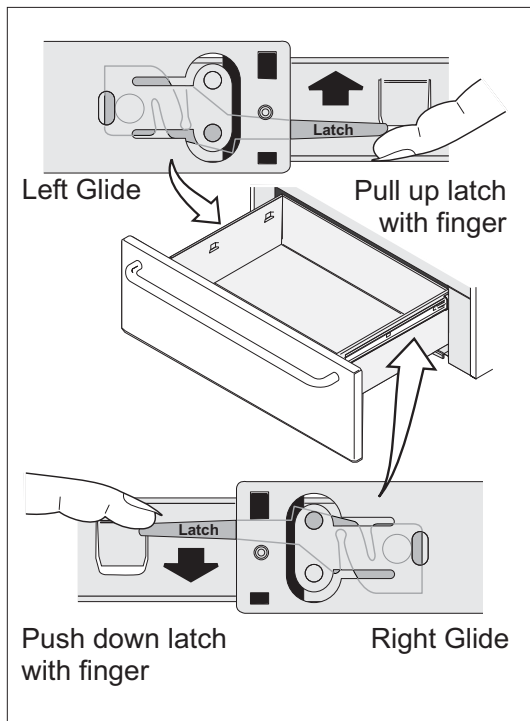

To remove Warmer Drawer

1. **⚠ CAUTION** Turn power off before removing the warmer drawer.
2. Open the drawer to the fully opened position.
3. Locate the latches on both sides of the warmer drawer.
4. Pull up on the left glide latch and push down on the right glide latch.
5. Pull the drawer away from the range.
6. To clean warmer drawer, gently scour with a soapy scouring pad, this will remove most spots. Rinse with a 1:1 solution of clear water and ammonia. If necessary, cover difficult spots with an ammonia-soaked paper towel for 30 to 40 minutes. Rinse with clean water and a damp cloth. Remove all cleaners or the porcelain may become damaged during future heating. DO NOT use spray oven cleaners on the cooktop.

To Replace Warmer Drawer:

1. Align the glide latches on both sides of the drawer with the slots on the drawer.
2. Push the drawer back into the range.



⚠ WARNING **Electrical Shock Hazard** can occur and result in serious injury or death. Disconnect appliance from electric power before cleaning and servicing the warmer drawer.

Avoid Service Checklist

Before you call for service - read this

You may save the cost and inconvenience of an unnecessary service call by first reviewing this easy to use Avoid-Service Check List of the most frequently encountered situations that are not the result of defective workmanship of materials. You will be charged for a service call while the appliance is in warranty if the problem is not caused by defective product workmanship or materials.

Your new appliance is a carefully engineered product. Many times, what appears to be a reason to call for service requires nothing more than a simple adjustment you can easily make in your own home or is normal operating characteristic of appliance under certain conditions.

This list is applicable to a variety of models; some of the items will not necessarily apply to your appliance.

PROBLEM

POSSIBLE CAUSE/SOLUTION

INSTALLATION

Range is not level.	1) Poor installation. See the suggested levelling instruction in the "General Information" section of this manual. When oven is level, cooktop may not appear to be level with countertop if the latter is not level. 2) Be sure floor is level and can adequately support range. Contact carpenter to correct sagging or sloping floor. 3) Kitchen cabinets misalignment may make range appear to be unlevel. Be sure cabinets are square and have sufficient room for range clearance (1.3 cm (1/2") each side).
---------------------	---

RANGE DOES NOT OPERATE

Entire range does not operate.	1) House fuse has blown or circuit breaker has tripped. Check and/or replace fuse or reset circuit breaker. 2) Cord/plug not plugged into wall outlet. Make sure cord plug is plugged tightly into outlet (Canada only). 3) Power outage. Check house lights to be sure.
--------------------------------	---

Oven does not operate.	1) No power to range. See steps "Entire range does not operate" above. 2) Oven selector control knob (some models) set between two positions. Turn selector control knob to BAKE or BROIL, etc. and make sure surface signal lights turn on. 3) Make sure the oven temperature control knob is set to the desired temperature. 4) Oven control beeps and displays -F1-, -F3- or -F9-. Electronic control has detected a fault condition. Push the CANCEL pad to clear the display and stop the beeping. Reprogram the oven. If fault recurs, record the fault number push the CANCEL pad and contact an authorized servicer. 5) Oven timer set on "time bake" function. Cancel the time bake function.
------------------------	---

Surface elements do not heat.	1) No power to range. Check steps "Entire range does not operate" above. 2) Control knobs set too low. At very low heat settings of the control knobs, the surface signal light may come on; however, surface unit does not operate. Turn the control knob to a slightly higher setting until the elements start heating. 3) Coil elements not seated properly in terminals. Turn temperature control knobs to OFF. Pull out and lift up coil elements. Straighten terminals on end of coil element if necessary. Replace elements properly into the element block. 4) Incorrect surface control knob turned on. Make sure the correct surface control is on for the surface unit to be used.
-------------------------------	---

Oven light does not work.	1) Burned-out light bulb. See "Oven Lamp" in the "General Information" section.
---------------------------	--

Control panel light does not operate (some models).	1) Lamp loose in sockets or burned-out. See Fluorescent Lamp in General Information section.
---	---

SURFACE UNITS

Surface elements too hot or too cold.	1) Raise or lower setting until proper amount of heat is obtained. 2) Use only flat bottom, evenly balanced, medium or heavy-weight cookware. Pans having a flat bottom heat better than warped pans. Cookware material affects heating. Heavy and medium weight pans heat evenly. Because light-weight pans heat unevenly, foods may burn easily.
---------------------------------------	--

Liquids boil at LOW setting of surface units.	1) Incorrect setting of the control knob. Turn control knob to a lower setting. 2) Cooking on right rear element. When the oven is operating, heated air escapes through the oven vent located directly under the right rear end coil element or little behind it. This will increase the heat input.
---	---

CERAMIC GLASS COOKTOP (some models)

Scratches or abrasions on cooktop surface.	1) See "Ceramic Glass Cooktop" section in "General Information" section.
--	---

NOTE: Clean sugary food spills on the heating surfaces as soon as possible, as these can cause cratering of these surfaces when hot.

PROBLEM**POSSIBLE CAUSE/SOLUTION****POOR BAKING RESULTS**

Baked foods too done or not done enough.	1) Actual oven temperature and cooking times may vary from recipe or box instruction. If this is a new range, temperatures may differ from your old range. Older ovens may drift in temperature. You may have to adjust your favorite recipe times and temperatures. 2) Use the pan size recommended in the recipe. Except when baking pies or breads, set the oven temperature control 13°C (25°F) lower when using glass pans.
Baked foods not evenly browned and/or raised.	1) A covered pan should not be used for baking, unless specified in the recipe. Foods baked in covered pans do not brown well. 2) Use clean, shiny pans. Blackened pans may cause burning of bottom. Use flat bottom pans. Warped pans may cause uneven baking. 3) If bottom of foods burns, raise the rack. If top of foods is too brown, lower the rack.
Baking time too long.	1) Frequently opening the oven door to check doneness. Oven temperature drops 10°C (18°F) or more each time door is opened. Set for shortest baking time and check baking process only at end of set time. Check baking progress through the window if available. 2) Placing a very large pan or several smaller pans very close together on one rack does not allow proper circulation of the oven air around the pans. A cookie sheet or sheet pan should not cover the entire oven rack. Allow at least 5.1 cm (2 in.) of space for air circulation on all sides of baking pan(s) and between pans and sides of the oven. When two racks are used, stagger pans so one is not directly above the other. 3) It will take approximately 10 minutes for the oven to reach the temperature setting. Better results will be obtained by pre-heating the oven before placing foods to be baked.
Oven steaming.	1) Moist foods may cause oven steaming. Cover the dish if appropriate for the food being cooked.
Fan noise during cooking operation.	1) A cooling fan may automatically turn on and off to cool internal parts. It is normal, and the fan may continue to run even after oven is turned off.

BROILING

Oven smokes excessively during broiling.	1) Open the door to the broil stop position. 2) Add 3 to 4 cups of water in your broiler pan to completely cover the bottom of the pan. Position food on grid and broil. The water catches the grease from the broiling food, cools the grease and reduces smoking. 3) Meat too close to the element. Lower the rack. 4) Remove excess fat from the meat. Slash remaining fat edges to prevent curling; do not cut into lean. 5) Always place the grid on your broiler pan with the slots down to allow grease to drip into the pan. 6) Grease has built up on oven surfaces. Regular cleaning is mandatory when broiling frequently. Old grease or food spatters cause excessive smoking.
--	--

SELF-CLEANING OVEN (SOME MODELS)

Self-clean cycle does not work.	1) Follow steps specified in this manual for appropriate settings of controls. 2) Door was not closed properly. Close door and start appropriate clean cycle again.
Soil not completely removed after self-cleaning cycle.	1) Failure to clean the bottom or front top of oven or door area, these surfaces get hot enough to burn on residue. Self cleaning of area underneath a closed door is not efficient. Clean these areas before the self-cleaning cycle is started. Burned on residue may be cleaned with a stiff nylon brush and water or nylon scrubber. Be careful not to damage the oven seal. 2) Clean cycle too short. Put oven through an additional cycle. 3) Check for temporary loss of power. Reset the controls and put the oven through another self-clean cycle.
There's some strange noise at the beginning of the self-clean cycle.	1) These are normal; they are caused by the oven door lock mechanism.

Avoid Transportation Damage to your Range

If you have to move your range into/out of your residence or when moving to a new home, it is suggested that you take the following precautions:

1. Screw in the levelling legs under the range.
2. Remove the racks and other utensils from the oven, and from the lower drawer.
3. Use adhesive tape to firmly secure the door and the drawer to the side panels. Also attach the electric power cord in the same manner.
4. Use a two-wheeled dolly with strap and fasten the range to it. Cover the appliance with a heavy blanket to prevent scratches and dents.
5. Avoid pulling or pushing the control panel when moving the appliance.



Major Appliance Warranty Information

Your appliance is covered by a one year limited warranty. For one year from your original date of purchase, Electrolux will pay all costs for repairing or replacing any parts of this appliance that prove to be defective in materials or workmanship when such appliance is installed, used and maintained in accordance with the provided instructions.

Exclusions **This warranty does not cover the following:**

1. Products with original serial numbers that have been removed, altered or cannot be readily determined.
2. Product that has been transferred from its original owner to another party or removed outside the USA or Canada.
3. Rust on the interior or exterior of the unit.
4. Products purchased "as-is" are not covered by this warranty.
5. Food loss due to any refrigerator or freezer failures.
6. Products used in a commercial setting.
7. Service calls which do not involve malfunction or defects in materials or workmanship, or for appliances not in ordinary household use or used other than in accordance with the provided instructions.
8. Service calls to correct the installation of your appliance or to instruct you how to use your appliance.
9. Expenses for making the appliance accessible for servicing, such as removal of trim, cupboards, shelves, etc., which are not a part of the appliance when it is shipped from the factory.
10. Service calls to repair or replace appliance light bulbs, air filters, water filters, other consumables, or knobs, handles, or other cosmetic parts.
11. Surcharges including, but not limited to, any after hour, weekend, or holiday service calls, tolls, ferry trip charges, or mileage expense for service calls to remote areas, including the state of Alaska.
12. Damages to the finish of appliance or home incurred during installation, including but not limited to floors, cabinets, walls, etc.
13. Damages caused by: services performed by unauthorized service companies; use of parts other than genuine Electrolux parts or parts obtained from persons other than authorized service companies; or external causes such as abuse, misuse, inadequate power supply, accidents, fires, or acts of God.

DISCLAIMER OF IMPLIED WARRANTIES; LIMITATION OF REMEDIES

CUSTOMER'S SOLE AND EXCLUSIVE REMEDY UNDER THIS LIMITED WARRANTY SHALL BE PRODUCT REPAIR OR REPLACEMENT AS PROVIDED HEREIN. CLAIMS BASED ON IMPLIED WARRANTIES, INCLUDING WARRANTIES OF MERCHANTABILITY OR FITNESS FOR A PARTICULAR PURPOSE, ARE LIMITED TO ONE YEAR OR THE SHORTEST PERIOD ALLOWED BY LAW, BUT NOT LESS THAN ONE YEAR. ELECTROLUX SHALL NOT BE LIABLE FOR CONSEQUENTIAL OR INCIDENTAL DAMAGES SUCH AS PROPERTY DAMAGE AND INCIDENTAL EXPENSES RESULTING FROM ANY BREACH OF THIS WRITTEN LIMITED WARRANTY OR ANY IMPLIED WARRANTY. SOME STATES AND PROVINCES DO NOT ALLOW THE EXCLUSION OR LIMITATION OF INCIDENTAL OR CONSEQUENTIAL DAMAGES, OR LIMITATIONS ON THE DURATION OF IMPLIED WARRANTIES, SO THESE LIMITATIONS OR EXCLUSIONS MAY NOT APPLY TO YOU. THIS WRITTEN WARRANTY GIVES YOU SPECIFIC LEGAL RIGHTS. YOU MAY ALSO HAVE OTHER RIGHTS THAT VARY FROM STATE TO STATE.

If You Need Service Keep your receipt, delivery slip, or some other appropriate payment record to establish the warranty period should service be required. If service is performed, it is in your best interest to obtain and keep all receipts. Service under this warranty must be obtained by contacting Electrolux at the addresses or phone numbers below.

This warranty only applies in the USA and Canada. In the USA, your appliance is warranted by Electrolux Major Appliances North America, a division of Electrolux Home Products, Inc. In Canada, your appliance is warranted by Electrolux Canada Corp. Electrolux authorizes no person to change or add to any obligations under this warranty. Obligations for service and parts under this warranty must be performed by Electrolux or an authorized service company. Product features or specifications as described or illustrated are subject to change without notice.

USA
1.800.944.9044
Electrolux Major Appliances
North America
P.O. Box 212378
Augusta, GA 30907



Canada
1.800.668.4606
Electrolux Canada Corp.
5855 Terry Fox Way
Mississauga, Ontario, Canada
L5V 3E4