

Frigidaire Dishwasher

Use & Care Manual

640 Series



Record All Information For Future Reference

Brand: _____ Purchase Date: _____

Model #: _____

Serial #: _____
(see Features page for location)

Questions? 1-800-944-9044

(United States)

1-866-213-9397

(Canada)

Visit our Web Site at
www.frigidaire.com

Product Registration Card

Please fill in completely, sign and return promptly!



Safety

Instructions 2



Features 3



Normal Operating

Sounds 4



Operating

Instructions 4-5



Preparing and

Loading Dishes 6-7



Dishwasher Dispenser

and Detergents 8-9



Factors Affecting

Performance 9



Care and

Cleaning 10



Connecting Portable

Dishwasher 11-12



Solutions to Common

Dishwashing Problems ...13-15



Consumer Services

Warranty & Service 16



Versión en español

Si desea obtener una copia en español de este Manual del Usuario, sírvase escribir a la dirección que se incluye a continuación. Solicite la P/N 154403701, **Spanish Use & Care Manual**, Electrolux Home Products North America, P.O. Box 212378, Augusta, GA 30917.

READ AND SAVE THESE INSTRUCTIONS

P/N 154427901 (0203)



Important Safety Instructions

WARNING

This symbol will help alert you to such dangers as personal injury, burns, fire and electrical shock.

WARNING

To reduce the risk of fire, electrical shock, or injury when using your dishwasher, follow basic precautions including the following:

- Read all instructions before using your dishwasher.
- Use your dishwasher only as instructed in this Use and Care Manual.
- This Manual does not cover every possible condition and situation that may occur. Use common sense and caution when installing, operating and maintaining any appliance.
- **DISHWASHER MUST BE ELECTRICALLY GROUNDED.** Read the Installation Instructions for details.
- This dishwasher is designed to operate on regular house current (120 V, 60 Hz). Use a circuit equipped with a 15 ampere fuse or circuit breaker. Use a 20 ampere fuse if dishwasher is connected with a food waste disposer.
- Do not operate dishwasher unless all enclosure panels are in their proper place.
- To avoid entrapment and/or suffocation, remove door or door latch mechanism from any dishwasher that is discarded or not in use.
- Keep young children and infants away from dishwasher when it is operating.
- Do not let children abuse, sit, stand or play on door or racks of a dishwasher.
- Use only detergents and rinse agents recommended for use in a dishwasher.
- Store dishwasher detergent and rinse agents out of the reach of children.
- Do not wash plastic items unless marked "dishwasher safe" or the equivalent. Check with manufacturer for recommendations, if not marked. Items that are not dishwasher safe may melt and create a potential fire hazard.
- If the dishwasher drains into a food disposer, make sure disposer is completely empty before running dishwasher.
- Disconnect electrical power to dishwasher before servicing.
- Repairs should be done by a qualified technician.
- Do not tamper with controls.
- Do not touch the heating element during or immediately after use.
- Use care unloading the dishware when the SANITIZE option has been selected. Contents may be hot to the touch immediately after the end of cycle.
- Water vapor from the vent may be hot to the touch when the SANITIZE option has been selected. Use care and do not let small children play around or touch the vent area of the dishwasher.
- When loading items to be washed:
 - Locate sharp items and knives so that they are not likely to damage the door seal or tub.
 - Load sharp items and knives with the handles up to reduce the risk of cut-type injuries.
- Under certain conditions, hydrogen gas may be produced in a hot water system that has not been used for 2 weeks or more. **HYDROGEN GAS IS EXPLOSIVE.** If hot water system has not been used for such a period, before using dishwasher, turn on all hot water faucets and let water flow from each for several minutes. This will release any accumulated hydrogen gas. **HYDROGEN GAS IS FLAMMABLE.** Do not smoke or use an open flame during this time.
- Do not store or use combustible materials, gasoline or other flammable vapors and liquids in the vicinity of this or any other appliance.

**SAVE THESE
INSTRUCTIONS**



Dishwasher Features

Your dishwasher cleans by spraying a mixture of hot water and detergent through the spray arms against soiled surfaces. Each cycle begins with a pre-drain. Next, the dishwasher fills with water covering the filter area. Water is then pumped through the filter and spray arms. Soil particles go down the drain as the water is pumped out and replaced with clean water. The number of water fills will vary with the cycle being used.

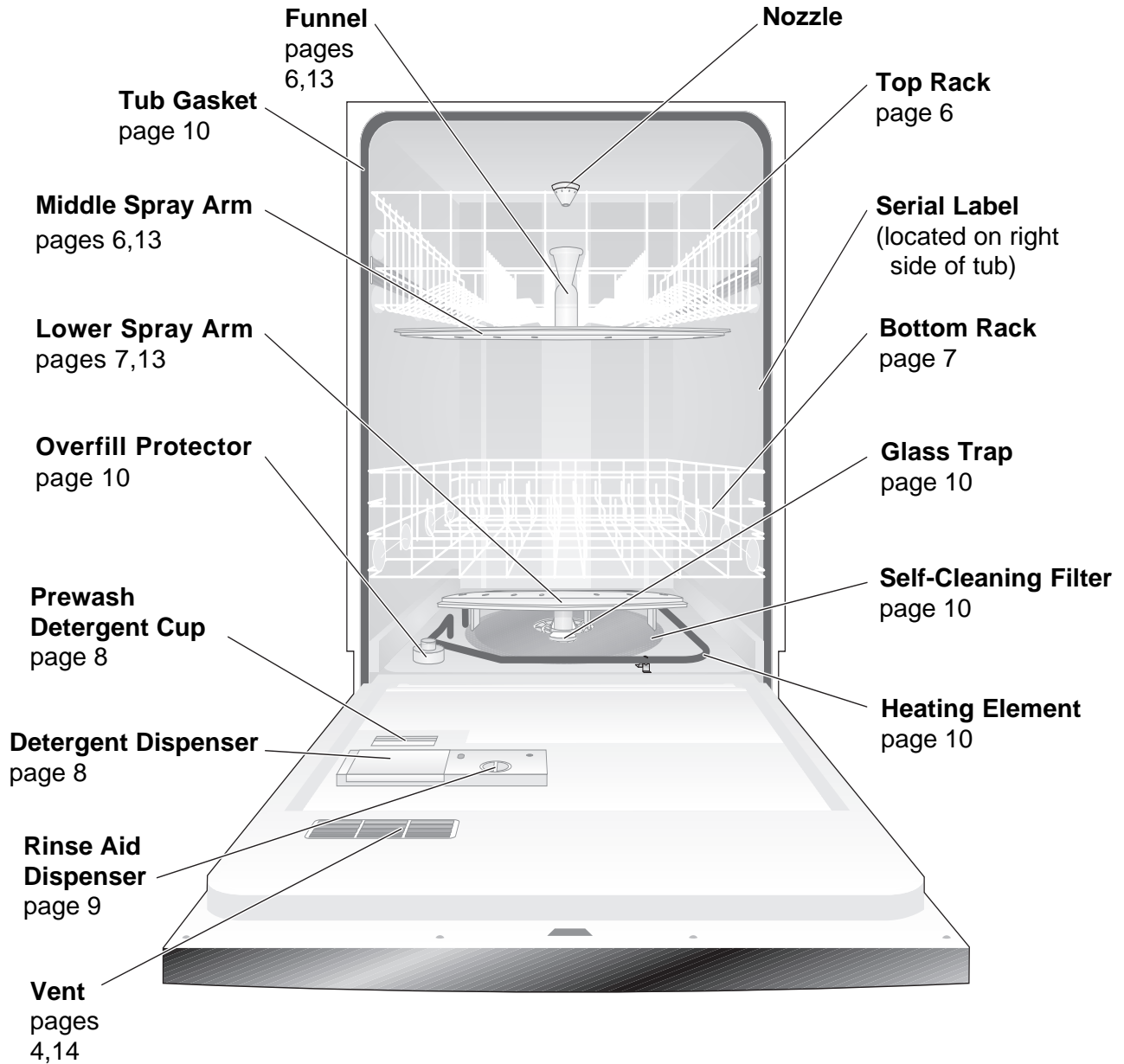



Operating Instructions

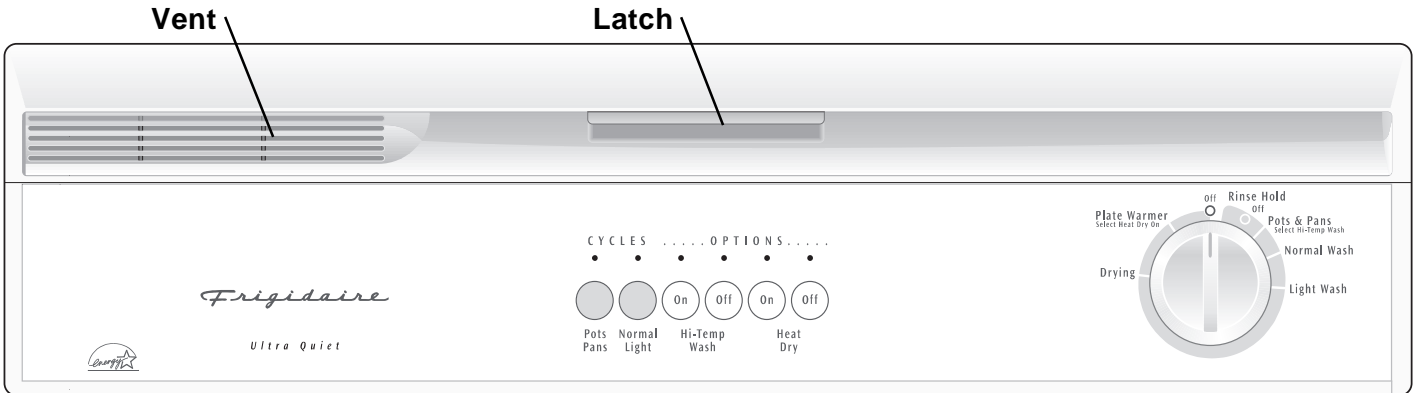

Appearance may vary from your model.

Very Important Information— Read Before Operating Your Dishwasher!



Normal Operating Sounds

This dishwasher does not sound like most dishwashers—IT'S QUIETER!

Your Precision Wash System® dishwasher uses energy efficient motors for the wash and drain portions of the cycle you select. Each cycle has a series of water fills and drains for washing and rinsing dishes. As each cycle begins, you may—or may not—hear the drain motor.

The next sound you will hear is the splashing water as it enters the tub. Then the lower arm rotates and circulates water. This is followed by a pause and a slightly different sound as the upper arm sprays water. If you listen closely, you will hear the change in sound as the wash action switches from one arm to the other.

PLEASE BE ADVISED: If you compare this dishwasher to previous models, you may be surprised at what you DON'T hear!

Getting Started

1. Load dishwasher (See Preparing and Loading Dishes).
2. Add detergent (See Dishwasher Dispenser & Detergents).
3. Add rinse aid, if needed (See Rinse Aid).
4. Select desired cycle (See Cycle Chart). The indicator will show red when selected.
5. Select desired energy OPTIONS (See Energy Options). The indicator will show red when selected.
6. Turn dial clockwise to selected cycle.
7. For instructions on connecting the portable dishwasher, see "Connecting and Disconnecting the Portable/Convertible Dishwasher."
8. Run hot water faucet nearest dishwasher until water is hot. Turn water off.
9. To start, close door to latch.

Status Indicator Light (available on select models)

The HEATING DELAY light means the cycle is being extended to heat water to proper temperature in the main wash.

Plate Warmer

For warming dishes and serving plates before serving hot foods:

- Load clean plates and dishes to be warmed.
- Turn dial to PLATE WARMER.
- Select HEAT DRY ON option.



Operating Instructions (continued)

Wash Cycle Selections

Note: Cycle times are approximate and will vary with options selected.

Cycle Chart					
Cycle	Description	To Select Cycle	Water (approx.)	Time* (approx.)	Washes/Rinses
Pots & Pans	For pots, pans, casseroles, and dinnerware with dried-on or baked-on soils.	<ul style="list-style-type: none"> • Press POTS & PANS pad. • Select HI-TEMP WASH ON option. • Select other desired OPTIONS. • Turn dial to POTS & PANS. 	7.2 gal. 6.0 imp. gal. 27.3 liters	85 min.	2 washes 4 rinses
Normal Wash	For regularly soiled dishes and silverware.	<ul style="list-style-type: none"> • Press NORMAL/LIGHT pad. • Select desired OPTIONS. • Turn dial to NORMAL WASH. 	6.0 gal. 5.0 imp. gal. 22.7 liters	78 min.	2 washes 3 rinses
Light Wash	For lightly soiled or pre-rinsed dishes and silverware.	<ul style="list-style-type: none"> • Press NORMAL/LIGHT pad. • Select desired OPTIONS. • Turn dial to LIGHT WASH. 	4.8 gal. 4.0 imp. gal. 18.2 liters	71 min.	1 wash 3 rinses
Rinse Hold	For rinsing dishes that will be washed later.	<ul style="list-style-type: none"> • DO NOT USE detergent. • Turn dial to RINSE HOLD. 	1.2 gal. 1.0 imp. gal. 4.5 liters	6 min.	1 rinse

* Includes dry time.

Energy Options

Hi-Temp Wash Option

When HI-TEMP WASH ON option is selected, the dishwasher heats the water in the main wash to approximately 140°F (60°C). Wash action will continue but timer will not advance until proper temperature is reached. The hotter water provided by this option helps activate dishwasher detergent to clean food grease and soil from dishes. HI-TEMP WASH ON option can be used with any cycle except RINSE HOLD.

To turn off option, select HI-TEMP WASH OFF.

Heat Dry Option

The HEAT DRY ON option will provide faster drying since the heating element is on during the drying portion of cycle.

HEAT DRY OFF option saves electricity since the heating element is off during the drying portion of cycle. To speed the drying process, open the door slightly after the cycle is

complete. Some water droplets may remain on door and tub and in areas where dishes touch silverware basket or rack.

With either option, you may see water vapor coming from the vent during the washing and/or drying portion of the cycle. On some models, the vent is closed during washing to hold moisture and sound inside and then opens for drying.

The drying option may be changed at any time during the cycle and affects only the drying period.



Preparing and Loading Dishes

Dish Preparation

Scrape away large pieces of food, bones, pits, toothpicks, etc. The continuous filtered wash system will remove remaining food particles. Burned-on foods should be loosened before loading. Empty liquids from glasses and cups.

Foods such as mustard, mayonnaise, vinegar, lemon juice and tomato based products may cause discoloration of stainless steel and plastics if allowed to sit for a long period of time. Unless the dishwasher is to be operated at once, it is best to rinse off these food soils.

- Load racks so that large items do not prevent the detergent dispenser from opening.
- Check manufacturer's recommendations before washing items in question.
- If the dishwasher drains into a food disposer, **be sure disposer is completely empty before starting dishwasher.**

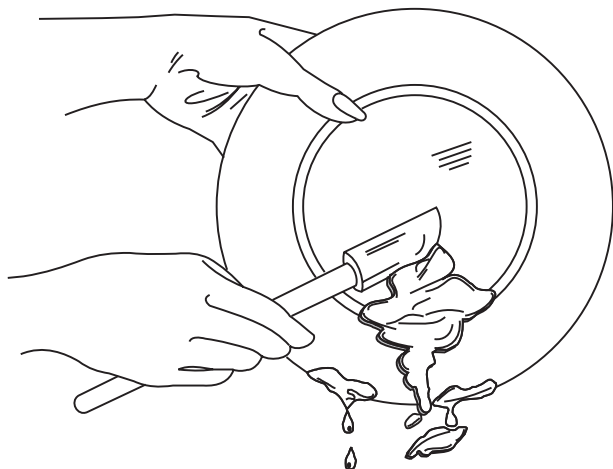

Loading the Top Rack

Features and appearance of racks and silverware basket may vary from your model.

Important: Do not cover the funnel when loading.

The top rack is designed for cups, glasses, small plates, saucers and bowls.

Load glasses in top rack. Damage may occur if placed in bottom rack.

Load plastic items in top rack only. Melting may occur if placed in bottom rack.

Load items with open ends facing down for better cleaning and draining.

Damage may occur if delicate items touch each other during dishwasher operation.

Long-handled knives and utensils can be placed in top rack.

Be sure nothing protrudes through the bottom of the rack to block rotation of middle spray arm.

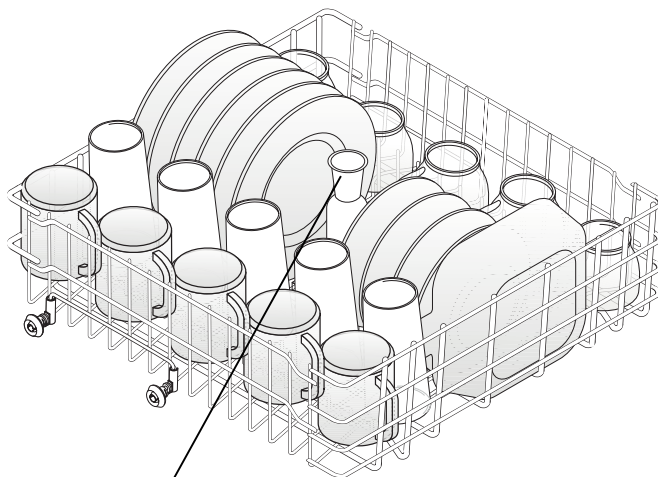

Do not cover funnel



Preparing and Loading Dishes (continued)

Loading the Bottom Rack

Features and appearance of racks and silverware basket may vary from your model.

Make sure tall items do not block spray arm rotation.

Place plates and platters so that they do not touch.

Place bowls, casseroles and sauce pans with the soiled surface facing down or toward the center. Tilt slightly for better drainage.

Be sure pan handles do not protrude through the bottom of the rack and block the spray arm rotation.

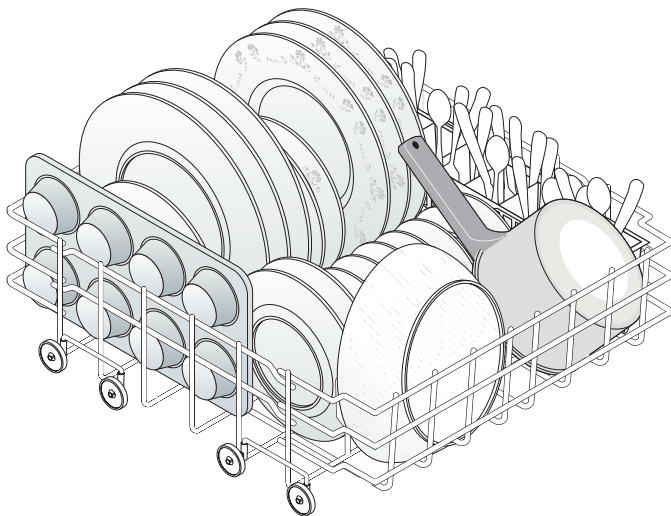

Loading the Silverware Basket

Mix spoons, forks and knives to prevent nesting. Mixing items gives better cleaning and drying.

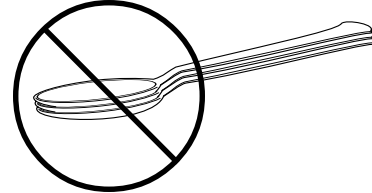

For safety, load sharp knives and forks with handles up.

Be sure nothing protrudes through bottom of basket or rack to block the spray arm.

Do not mix silver and stainless to avoid damaging the silver finish.

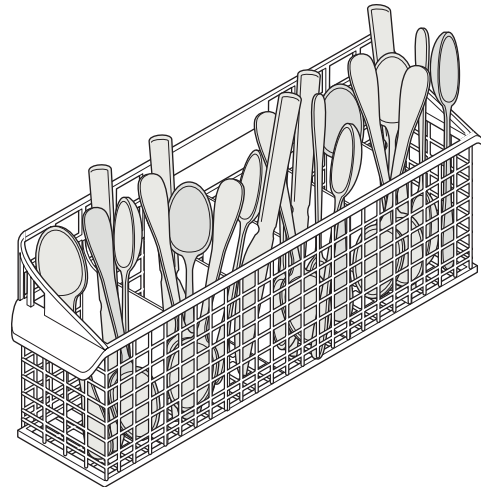

Adding a Dish

To add or remove items after wash cycle starts:

- Unlatch door and wait a few seconds until wash action stops before opening.
- Add the item and wait a few seconds to allow cold air to slowly expand inside dishwasher.
- Close door firmly to latch and resume cycle.



Dishwasher Dispenser & Detergents

Filling the Detergent Dispenser

The detergent dispenser has one covered and one uncovered cup. Detergent in the uncovered cup falls into the dishwasher when the door is closed. The covered cup opens automatically to release detergent.

- Use only fresh automatic dishwashing detergent. Other detergents will cause oversudsing.
- Add detergent just before starting cycle.
- Store detergent in a cool, dry location. Moist or caked detergent will not dissolve properly.

How much Detergent to use

The amount of detergent to use depends on the water hardness. Water hardness is measured in grains per gallon. Using too little detergent can result in poor cleaning and hard water filming or spotting. Using too much detergent in soft water can cause a permanent film called etching. Your local water company, water softener company or county extension agent can tell you the water hardness in your area.

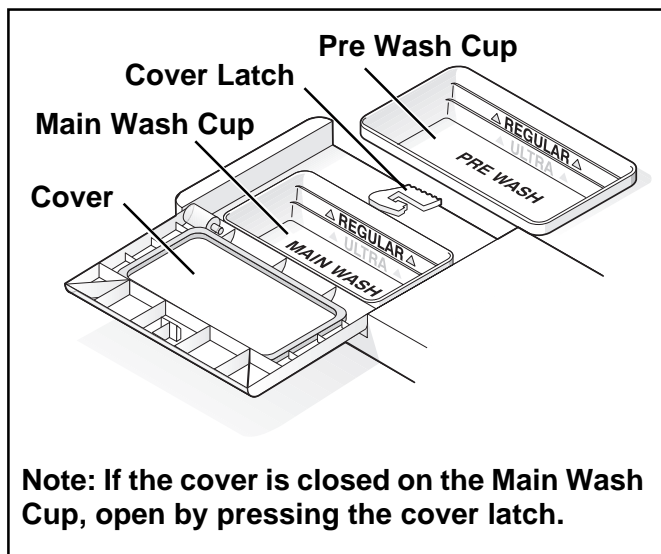

Detergent Usage Guide				
Cycle	Soft Water (0-3 grains)	Medium Hard Water (4-8 grains)	Hard Water (9-12 grains)	Very Hard Water* (over 12 grains)
Pots & Pans Normal Wash	2 teaspoons (each cup— 1/4 full)	5 teaspoons (each cup—fill to line above "Regular")	8 teaspoons (each cup— completely full)	Each Cup— Completely Full (water softener recommended)
Light Wash	2 teaspoons (Main Wash cup— 1/4 full)	5 teaspoons (Main Wash cup—fill to line above "Regular")	8 teaspoons (Main Wash cup— completely full)	Main Wash Cup— Completely Full (water softener recommended)
Rinse Hold	No Detergent	No Detergent	No Detergent	No Detergent (water softener recommended)

***Note:** For very hard water, detergent alone may not be enough. A water softener is recommended to improve water quality and dishwashing performance. Try adding more detergent at the beginning of the main wash portion of the cycle. As a rule, use 1 teaspoon for each grain above 12. Unlatch the door, open slowly and add detergent to the bottom of the tub. Close the door to latch and the dishwasher will continue through the cycle.



Dishwasher Dispenser & Detergents (continued)

Rinse Aid

Rinse aid greatly improves drying and reduces water spots and filming. Water “sheets” off dishes rather than forming water droplets that cling and leave spots.

A dispenser, located next to the detergent cup, automatically releases a measured amount of rinse aid during the last rinse. If spotting and poor drying are problems, increase the amount of rinse aid dispensed by rotating the dial to a higher number. The dial is located under the dispenser cap. The indicator will be dark when full and will show clear when it is time to refill.

To add liquid rinse aid, turn dispenser cap 1/4 turn counterclockwise and lift out. Pour in rinse aid until liquid touches the indicated fill level. Replace cap.

Do not overfill since this can cause oversudsing. Wipe up any spills with a damp cloth.

The dispenser holds enough for 35 to 140 washes, depending on setting.

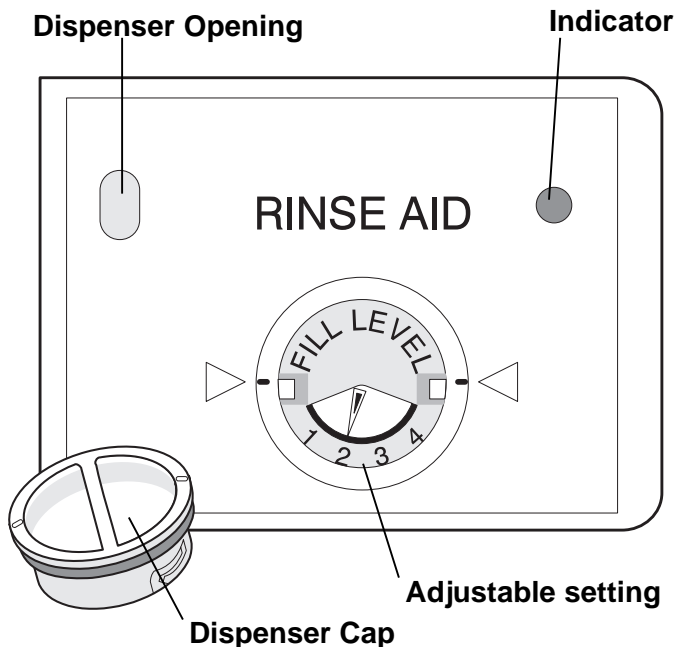

Factors Affecting Performance

Water Pressure

The hot water line to dishwasher must provide water pressure between 20 and 120 psi.

Low water pressure may occur when laundry or showers are in operation. Wait until water use is reduced before starting dishwasher.

Water Temperature

Hot water is needed for best dishwashing and drying results. Water entering dishwasher should be at least 120°F (49°C) to give satisfactory results.

To check water temperature entering dishwasher:

- Turn on hot water faucet nearest dishwasher for several minutes to clear cool water from pipes.
- Hold a candy or meat thermometer in stream of water to check the temperature.
- If temperature is below 120°F (49°C), have a qualified person raise the hot water heater thermostat setting.

Important: Before starting a cycle, run hot water to clear cool water from pipe.



Care and Cleaning

⚠️ WARNING

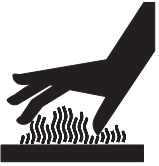

Burn Hazard

Allow heating element to cool before cleaning the interior. Failure to do so can result in burns.

Outside—Occasionally wipe with a mild nonabrasive detergent and water. Rinse and dry.

Inside—The inside of the dishwasher is self-cleaning with normal use. If needed, clean around the tub gasket area with a damp cloth.

The filter is self-cleaning. A glass trap located in the center of the filter is designed to collect pieces of broken glass, straws, bones and pits. To remove items in glass trap, grasp handle, lift out, empty and replace.

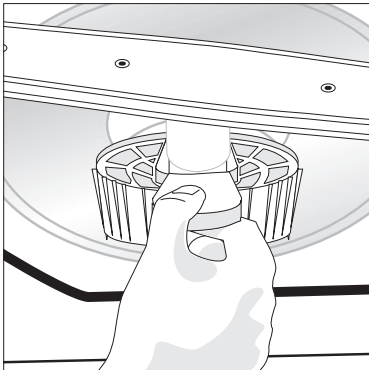

Note: Hard water may cause lime deposit buildup on the interior of the dishwasher. For cleaning instructions see “Removing Spots and Film” section.

Overfill Protector—keeps dishwasher from overflowing and is located in the left front corner of the tub.

- Clean occasionally with household cleaner containing vinegar or bleach to dissolve any buildup.
- Overfill Protector should move up and down freely about one inch. If it does not move, lift and clean underneath.

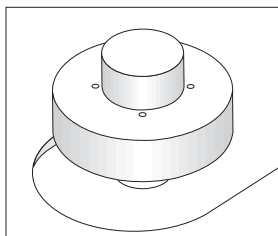

Care of Drain Air Gap

If a drain air gap was installed for your built-in dishwasher, check to make sure it is clean so the dishwasher will drain properly. A drain air gap is usually mounted on countertop and can be inspected by removing the cover. This is not part of your dishwasher and is not covered by warranty.

⚠️ CAUTION

Property Damage Hazard

Freezing temperatures may cause water lines to rupture. Be sure all supply lines to and circulating lines within dishwasher are protected. Failure to do so could result in property damage.

Winterizing

A dishwasher left in an unheated place should be protected from freezing. Have a qualified person do the following:

To Disconnect Service:

1. Turn off electrical power to the dishwasher at the supply source by removing fuses or tripping circuit breaker.
2. Shut off water supply.
3. Place a pan under the inlet valve. Disconnect water line from inlet valve and drain into pan.
4. Disconnect drain line from pump and drain water into pan.

Note: See Installation Instructions for more details.

To Restore Service:

1. Reconnect the water, drain, and electrical power supply.
2. Turn on water and electrical power supply.
3. Fill both detergent cups and run dishwasher through a NORMAL cycle.
4. Check connections to make sure they do not leak.

Note: See Installation Instructions for more details.



Connecting and Disconnecting the Portable/ Convertible Dishwasher

The portable/convertible dishwasher must be connected to a faucet and electrical outlet each time it is used. Follow directions on this page to properly connect dishwasher.

Faucet Adapter Assembly

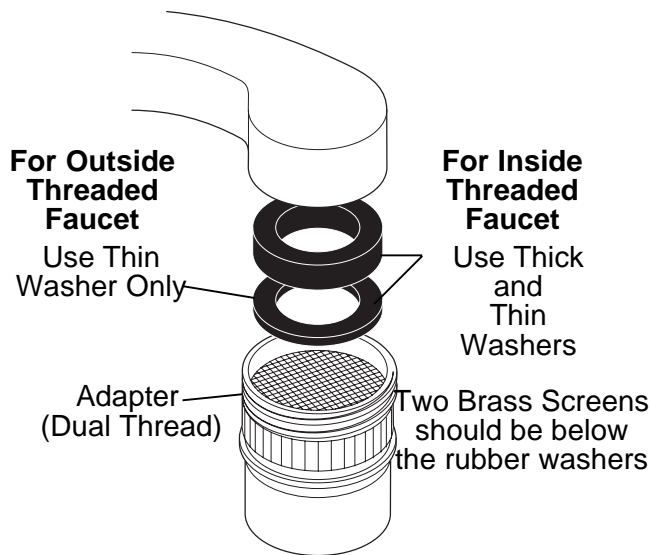

Connecting the Portable Faucet Adapter Assembly

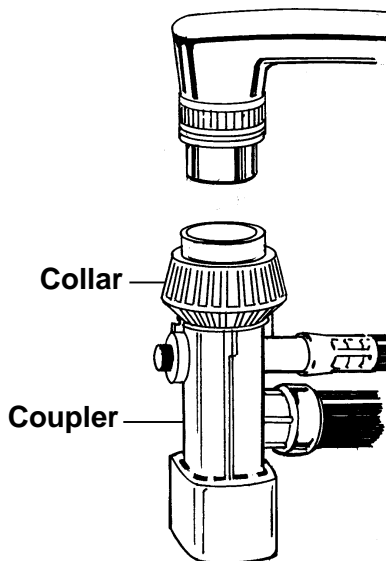

IMPORTANT: Make sure door is latched before moving dishwasher.

The power cord, faucet coupler and hoses are located in a compartment in back of dishwasher. A special adapter must be installed on faucet before you can connect dishwasher.

1. Remove faucet adapter assembly from literature package.
2. Unscrew existing sink faucet aerator.
3. Check faucet spout to see if threads are inside or outside.
 - If threads are on *inside* of faucet spout, use both thick and thin rubber washers.
 - If threads are on *outside* of faucet spout, use thin rubber washer only.
 - If faucet has no threads, an adapter kit with instructions for attachment to a non-threaded spout is available at most hardware stores.
4. Assemble faucet spout as shown. Make sure the two brass screens are located below the rubber washers.

Connecting the Portable/Convertible Dishwasher

1. Run water at faucet until it is hot. Turn off faucet.
2. Pull hoses out of compartment.
3. Push collar down and slip faucet connector onto faucet adapter.
4. When connector snaps into place, release collar.
5. Slowly turn on hot water all the way.
6. Plug power cord into grounded outlet.



Connecting and Disconnecting the Portable/Convertible Dishwasher (continued)

Getting Water While Dishwasher is Running

You can get water from the faucet while the dishwasher is connected. However, avoid getting water when the dishwasher is filling or draining.

1. Press red button on coupler to get the water you want. The faucet is set on hot, adjust faucet if you want cold.
2. Be sure hot water is turned back on all the way to complete cycle.

Disconnecting the Portable/Convertible Dishwasher

1. When cycle has finished, turn off hot water.
2. Press red button on coupler to release water pressure being careful not to release coupler.
3. Press down on collar to release coupler.
4. Empty remaining water from coupler and return it to compartment.
5. Unplug power cord and return it to compartment.

IMPORTANT: A sink spray attachment hose can burst due to constant water pressure while in use. If your spray hose is installed on same water line as the dishwasher, we suggest you disconnect the sink spray attachment and plug the hole.

⚠ WARNING

Avoid fire hazard or electrical shock. Do not use an adapter plug, extension cord or remove grounding prong from electrical power cord.

Failure to follow this warning can cause serious injury, fire or death.

Electrical Connection for a Portable/Convertible Dishwasher

An electrical supply of 120 volts, 60 Hz, AC only, 15 amps is required. For your safety, the dishwasher must be grounded. If there is a malfunction or breakdown, grounding will reduce risk of electrical shock. This dishwasher has a power cord with a 3-prong grounding plug. It must be plugged into a mating 3-prong grounding type receptacle, installed and grounded in accordance with the National Electrical Code and any local codes and ordinances.

Grounding type wall receptacle

Do not under any circumstances cut, remove or bypass the grounding prong from this plug.

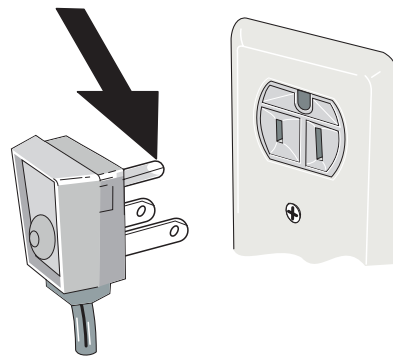

Power supply cord with 3-prong grounding plug

Converting to Built-In

Your portable dishwasher can be converted to a built-in (undercounter) model. A conversion kit No. 154241302 is required and is available from your local dealer or distributor. Instructions are included with the kit.



Solutions to Common Dishwashing Problems

Before calling for service, review this list. It may save you both time and expense. This list includes common experiences that are not the result of defective workmanship or material in your dishwasher.

Food Soils Left on Dishes

- Choose another cycle for longer washing time.
- Check rack loading section for proper loading—avoid nesting items.
- Home water pressure may be too low—should be 20 to 120 pounds per square inch (psi).
- Check incoming water temperature. It should be at least 120°F (49°C). (See Factors Affecting Performance.)
- Select HI-TEMP WASH option.
- Check water hardness. For extremely hard water, it may be necessary to install a water softener. (See Detergent Chart.)
- Use fresh detergent.
- Check to make sure funnel in top rack is not blocked.
- Make sure items are not blocking the spray arms, preventing them from rotating.

Dishes not Dry

- Select Heat Dry option.
- Make sure the rinse aid dispenser is filled.
- Increase the amount of rinse aid. (See Rinse Aid.)
- Check the incoming water temperature. Be sure it is at least 120°F (49°C).
- Check for proper loading—avoid nesting items.
- Plastic items may need to be towel dried.
- Cups with a concave bottom will collect water.

Glassware/Flatware Spotted or Cloudy

- Check water hardness. For extremely hard water, it may be necessary to install a water softener. (See Detergent Chart.)
- Water temperature may be low. Avoid extremely low or high temperatures. (See Factors Affecting Performance.)
- Avoid overloading and improper loading. (See Preparing and Loading Dishes.)
- Use fresh detergent. Old detergent is ineffective.
- Make sure rinse aid dispenser is filled.
- Check to see that proper amount of detergent is being used for cycle selected. Also, check phosphate level. (See Detergent Dispenser.)
- Home water pressure may be too low—it should be 20 to 120 pounds per square inch (psi).

Dishware Chipped

- Load with care and do not overload. (See Preparing and Loading Dishes.)
- Place delicate items in top rack.
- Place glasses securely against pins and not over pins.
- Load items so they are secure and don't jar loose when moving racks in and out. Move racks in and out slowly.
- Make sure tall glasses and stemware will clear top of tub when rack is pushed in.
- Fine antique china and crystal should be hand-washed.



Solutions to Common Dishwashing Problems

(continued)

Dishware Stained or Discolored

- Tea and coffee can stain cups. Remove the stains by hand washing in a solution of 1/2 cup (120 ml) bleach and one quart (1 L) of warm water. Rinse thoroughly.
- Iron deposits in water can cause a yellow or brown film. A special filter installed in the water supply line will correct this problem. (See Removing Spots and Film.)
- Aluminum utensils can leave gray/black marks when they rub against other items. Load properly.
- Certain high acid foods can cause discoloration of stainless steel and plastics if allowed to sit for a long period. Use the Rinse Hold cycle or rinse by hand if not operating dishwasher at once.
- Mixing stainless steel and silver utensils in silverware basket can cause pitting of the stainless steel blades. Avoid mixing stainless steel and silver.

Etching

- Using too much detergent in soft or softened water causes this film that cannot be removed.
- Adjust the amount of detergent based on the water hardness. (Check Detergent Chart.)
- Lower the water temperature.
- Use the Heat Dry Off option.

Detergent Left in Cups

- Detergent may be old. Discard and use fresh detergent.
- Be sure water action can reach the dispenser.
- Check to see if cycle has been completed.
- Make sure items do not prevent the detergent dispenser from opening.

Dishwasher Leaks

- Use only fresh detergent designed for automatic dishwashers. Measure detergent carefully. Try a different brand.
- Spilled rinse aid can cause foam and lead to overflowing. Wipe up any spills with a damp cloth.
- Check to see that dishwasher is level. (See Installation Instructions.)

Normal Sounds You Will Hear

- Normal sounds include water fill, water circulation and motor sounds.
- There is a noticeable change in sound when the wash action switches between the lower and middle spray arm. This is normal since each spray arm has its own sound.
- It is normal for dishwasher to pause (no sound) when the wash action is switching between the lower and middle spray arms.

Water in Bottom of Tub

- Water left in bottom of tub after cycle is complete is not normal. If water remains in the bottom of the tub, dishwasher may not be draining properly. (See Dishwasher Does Not Drain Properly.)

Vapor at Vent

- Water vapor escapes from the vent during the washing and/or drying part of cycle. This is normal.

Dishwasher Won't Run

- Check to see if circuit breaker is tripped or if a fuse is blown.
- Make sure water supply is turned on.
- Check to see if cycle is set correctly. (See Operating Instructions.)
- Make sure door is closed and latched.



Solutions to Common Dishwashing Problems

(continued)

Dishwasher Does Not Drain Properly

- If unit is hooked up to a food waste disposer, make sure the disposer is empty.
- Check to see if the knockout plug has been removed from inside the food waste disposer inlet.
- Check to see if drain hose is kinked.
- Make sure cycle is complete, not in a pause.

Cycle Takes a Long Time

- Is cycle in a water heating delay?

Dishwasher Won't Fill

- Is water supply turned on?
- Does overflow protector move up and down freely? (See Overflow Protector section.)

Dishwasher Has an Odor

- Soiled dishes left in dishwasher too long can create an odor. Use Rinse Hold cycle.
- There will be a "new" smell when first installed. This is normal.
- Check to see if unit is draining properly. (See Dishwasher Does Not Drain Properly.)

Stains on Tub Interior

- Washing large amounts of dishware with tomato based soil can cause a pink/orange appearance. This will not affect performance and will gradually fade over time. Pre-rinsing or using the Rinse Hold cycle will reduce the chance of staining. Using Heat Dry Off option will lessen staining.

Removing Spots and Film

Hard water can cause lime deposit buildup on the interior of the dishwasher. Dishes and glasses may also get spots and film for a number of reasons. (See Glassware/Flatware Spotted or Cloudy section.) To remove buildup, spots and film, clean using the following instructions:

1. Load clean dishes and glasses in normal manner. Do not load any metal utensils or silverware.
2. Do not add detergent.
3. Select the POTS & PANS cycle. Close and latch door to start.
4. Allow dishwasher to run for 25 minutes to reach the main wash portion of cycle.
5. Unlatch and open door and pour 2 cups of white vinegar into the bottom of dishwasher.
6. Close and latch door and allow the cycle to finish.

Note: If these conditions persist, a home water softener should be considered.

To customize your dishwasher to match your cabinets:

- You will need a trim kit.
- See Step 10 of Installation Instructions that came with your dishwasher for more information.



Warranty Information

Frigitidairre
Built for Generations

DISHWASHER WARRANTY *Your dishwasher is protected by this warranty*

	WARRANTY PERIOD	THROUGH OUR AUTHORIZED SERVICERS, WE WILL:	THE CONSUMER WILL BE RESPONSIBLE FOR:
FULL ONE-YEAR WARRANTY	One year from original purchase date.	Pay all costs for repairing or replacing any parts of this appliance which prove to be defective in materials or workmanship.	Costs of service calls that are listed under NORMAL RESPONSIBILITIES OF THE CONSUMER.*
EXTENDED LIMITED 2ND YEAR WARRANTY	Two years from original purchase date.	Replace any parts in the Water Distribution System which fail because of a manufacturing defect. This includes the motor, pump, lower wash arm and soft or hard food disposer on all models, plus the wash tower, upper spray arms with associated supply tube, and filter assembly on models including these features. Associated inlet and drain plumbing parts are not covered by this warranty.	Associated inlet and drain plumbing parts. Costs for pickup and delivery of the product required because of service; and all costs for labor and transportation.
EXTENDED LIMITED 2ND - 5TH YEAR WARRANTY	Second through fifth years from original purchase date.	(Electronic Controls, Nylon Racks and TufRacks) For models with electronic controls, replace any electronic control that fails due to a manufacturing defect. For models with nylon-coated racks or TufRacks, replace any original upper or lower nylon-coated rack or TufRack that peels or rusts due to a manufacturing defect.	Costs for pickup and delivery of the product required because of service; and all costs for labor and transportation.
EXTENDED LIMITED 2ND - 10TH YEAR	Second through tenth years from original purchase date.	Provide a replacement tub or door liner if the original tub or door liner fails to contain water because of a manufacturing defect.	Door seals; any costs for pickup and delivery of the product required because of service; and all costs for labor and transportation.
LIMITED WARRANTY (Applicable to the State of Alaska)	Time periods listed above.	All of the provisions of the full warranties above and the exclusions listed below apply.	Costs of the technician's travel to the home and any costs for pick up and delivery of the appliance required because of service.

In the U.S.A., your appliance is warranted by Electrolux Home Products, Inc. We authorize no person to change or add to any of our obligations under this warranty. Our obligations for service and parts under this warranty must be performed by us or an authorized Electrolux Home Products, Inc. servicer. In Canada, your appliance is warranted by Electrolux Canada Corp.

***NORMAL RESPONSIBILITIES OF THE CONSUMER**

This warranty applies only to products in ordinary household use, and the consumer is responsible for the items listed below:

1. Proper use of the appliance in accordance with instructions provided with the product.
2. Proper installation by an authorized servicer in accordance with instructions provided with the appliance and in accordance with all local plumbing, electrical and/or gas codes.
3. Proper connection to a grounded power supply of sufficient voltage, replacement of blown fuses, repair of loose connections or defects in house wiring.
4. Expenses for making the appliance accessible for servicing, such as removal of trim, cupboards, shelves, etc., which are not a part of the appliance when it was shipped from the factory.
5. Damages to finish after installation.
6. Replacement of light bulbs and/or fluorescent tubes (on models with these features).

EXCLUSIONS

This warranty does not cover the following:

1. CONSEQUENTIAL OR INCIDENTAL DAMAGES SUCH AS PROPERTY DAMAGE AND INCIDENTAL EXPENSES RESULTING FROM ANY BREACH OF THIS WRITTEN OR ANY IMPLIED WARRANTY.
Note: Some states do not allow the exclusion or limitation of incidental or consequential damages, so this limitation or exclusion may not apply to you.
2. Service calls which do not involve malfunction or defects in workmanship or material, or for appliances not in ordinary household use. The consumer shall pay for such service calls.
3. Damages caused by services performed by persons other than Electrolux Home Products, Inc., Electrolux Canada Corp., or their authorized servicers; use of parts other than genuine Electrolux parts; obtained from persons other than such servicers; or external causes such as abuse, misuse, inadequate power supply or acts of God.
4. Products with original serial numbers that have been removed or altered and cannot be readily determined.

IF YOU NEED SERVICE

Keep your bill of sale, delivery slip, or some other appropriate payment record. The date on the bill establishes the warranty period should service be required. If service is performed, it is in your best interest to obtain and keep all receipts. This written warranty gives you specific legal rights. You may also have other rights that vary from state to state. Service under this warranty must be obtained by contacting Electrolux Home Products, Inc. or Electrolux Canada Corp.

This warranty only applies in the 50 states of the U.S.A. and Puerto Rico, and Canada. Product features or specifications as described or illustrated are subject to change without notice. All warranties are made by Electrolux Home Products, Inc. In Canada, your appliance is warranted by Electrolux Canada Corp.

05-U-DW-01(Rev. 01/2002)

USA 800•944•9044
Electrolux Home Products, Inc.
P.O. Box 212378
Augusta, GA 30917

Canada 866•213•9397
Electrolux Canada Corp.
6150 McLaughlin Road
Mississauga, Ontario L5R 4C2